



**Agilent E5810B  
LAN/GPIB/USB  
Gateway**

**User's Guide**



**Agilent Technologies**

# Notices

© Agilent Technologies, Inc. 2013–2014

No part of this manual may be reproduced in any form or by any means (including electronic storage and retrieval or translation into a foreign language) without prior agreement and written consent from Agilent Technologies, Inc. as governed by United States and international copyright laws.

## Manual Part Number

E5810-90004

## Edition

Fourth Edition, March 25, 2014

Agilent Technologies, Inc.  
5301, Stevens Creek Blvd.  
Santa Clara, CA 95051 USA

## Warranty

**The material contained in this document is provided “as is,” and is subject to change, without notice, in future editions. Further, to the maximum extent permitted by the applicable law, Agilent disclaims all warranties, either express or implied, with regard to this manual and any information contained herein, including but not limited to the implied warranties of merchantability and fitness for a particular purpose. Agilent shall not be liable for errors or for incidental or consequential damages in connection with the furnishing, use, or performance of this document or of any information contained herein. Should Agilent and the user have a separate written agreement with warranty terms covering the material in this document that conflict with these terms, the warranty terms in the separate agreement shall control.**

## Technology Licenses

The hardware and or software described in this document are furnished under a license and may be used or copied only in accordance with the terms of such license.

## Restricted Rights Legend

U.S. Government Restricted Rights. Software and technical data rights granted to the federal government include only those rights customarily provided to end user customers. Agilent provides this customary commercial license in Software and technical data pursuant to FAR 12.211 (Technical Data) and 12.212 (Computer Software) and, for the Department of Defense, DFARS 252.227-7015 (Technical Data - Commercial Items) and DFARS 227.7202-3 (Rights in Commercial Computer Software or Computer Software Documentation).

## Safety Notices

### CAUTION

A **CAUTION** notice denotes a hazard. It calls attention to an operating procedure, practice, or the likes of that, if not correctly performed or adhered to, could result in damage to the product or loss of important data. Do not proceed beyond a **CAUTION** notice until the indicated conditions are fully understood and met.

---

### WARNING

A **WARNING** notice denotes a hazard. It calls attention to an operating procedure, practice, or the likes of that, if not correctly performed or adhered to, could result in personal injury or death. Do not proceed beyond a **WARNING** notice until the indicated conditions are fully understood and met.





---

## Safety Symbol

The following symbol on the instrument and in the documentation indicates precautions which must be taken to maintain safe operation of the instrument.

	DC (Direct current)
---	---------------------

## Regulatory Markings

	The CE mark is a registered trademark of the European Community. This CE mark shows that the product complies with all the relevant European Legal Directives.
	The C-tick mark is a registered trademark of the Spectrum Management Agency of Australia. This signifies compliance with the Australia EMC Framework regulations under the terms of the Radio Communication Act of 1992.
ICES/NMB-001	ICES/NMB-001 indicates that this ISM device complies with the Canadian ICES-00. Cet appareil ISM est conforme a la norme NMB-001 du Canada.
	South Korean Class A EMC Declaration This equipment is Class A suitable for professional use and is for use in electromagnetic environments outside of the home.
	This instrument complies with the WEEE Directive (2002/96/EC) marking requirement. This affixed product label indicates that you must not discard this electrical or electronic product in domestic household waste.
	This symbol indicates the time period during which no hazardous or toxic substance elements are expected to leak or deteriorate during normal use. Forty years is the expected useful life of the product.

## Safety Considerations

Read the information below before using this instrument.

The following general safety precautions must be observed during all phases of operation, service, and repair of this instrument. Failure to comply with these precautions or with specific warnings elsewhere in this manual violates safety standards for design, manufacture, and intended use of the instrument. Agilent Technologies assumes no liability for the customer's failure to comply with these requirements.

### CAUTION

- Use the device with the cables provided with the shipment.
  - If the device is used in a manner not specified by the manufacturer, the device protection may be impaired.
  - Always use dry cloth to clean the device. Do not use ethyl alcohol or any other volatile liquid to clean the device.
  - Do not permit any blockage of the ventilation holes of the device.
- 

### WARNING

- **Do not use the device if it appears damaged or defective.**
  - **Do not operate the device around flammable gases or fumes, vapor, or wet environments.**
  - **Observe all markings on the device before connecting any wiring to the device.**
  - **Turn off the output of the power supply before connecting to the output terminals.**
  - **When servicing the device, use only the specified replacement parts.**
  - **Do not install substitute parts or perform any unauthorized modification to the device.**
  - **Do not operate the device with the cover removed or loosened.**
  - **Use only the power adapter provided by the manufacturer to avoid any unexpected hazards.**
-

## Environmental Conditions

This instrument is designed for indoor use and in an area with low condensation. The table below shows the general environmental requirements for this instrument.

Environmental condition	Requirements
Temperature	Operating condition • 0 °C to 55 °C Storage condition • -40 °C to 70 °C
Humidity	Operating condition • Up to 80% RH at 40 °C (non-condensing) Storage condition • Up to 90% RH at 40 °C (non-condensing)
Altitude	Up to 4600 m
Pollution degree	2
Installation category	II (through an AC/DC adapter)

### NOTE

The E5810B LAN/GPIB/USB Gateway complies with the following safety and EMC requirements:

- IEC61326-1:2005 / EN61326-1:2006
- Canada: ICES/NMB-001: Issue 4, June 2006
- Australia / New Zealand: AS/NZS CISPR11:2004
- IEC 61010-1:2010 / EN 61010-1:2010 (3rd Edition)

## Waste Electrical and Electronic Equipment (WEEE) Directive 2002/96/EC

This instrument complies with the WEEE Directive (2002/96/EC) marking requirement. This affixed product label indicates that you must not discard this electrical or electronic product in domestic household waste.

### Product Category:

With reference to the equipment types in the WEEE directive Annex 1, this instrument is classified as a “Monitoring and Control Instrument” product.

The affixed product label is as shown below.



### Do not dispose in domestic household waste.

To return this unwanted instrument, contact your nearest Agilent Service Center, or visit

[www.agilent.com/environment/product](http://www.agilent.com/environment/product)

for more information.

## Declaration of Conformity (DoC)

The Declaration of Conformity (DoC) for this instrument is available on the Agilent Web site. You can search the DoC by its product model or description at the following Web address.

<http://regulations.corporate.agilent.com/DoC/search.htm>

### NOTE

If you are unable to search for the respective DoC, contact your local Agilent representative.

---

**THIS PAGE HAS BEEN INTENTIONALLY LEFT BLANK.**



# Table of Contents

## 1 E5810B Description

E5810B Hardware Description	2
E5810B front panel	2
E5810B rear panel	4
Default settings	5
Typical network connections	6
E5810B Software/Firmware Descriptions	9
E5810B operating features	9
Typical network operation	10
Software/firmware architecture	11
Typical network IP addressing	13
Communicating with the E5810B	16

## 2 Installing the E5810B

Installation Flowchart	20
Before Installing the E5810B	21
Check your PC	21
Rack mount the E5810B (optional)	21
E5810B related documentation	21
Getting Network Information	22
Local network information	22
Enterprise network information	22
Configuring the E5810B on a Local Network	24
Connecting the E5810B to a local network	24
Configuring the E5810B for a local network operation	26
Configuring the E5810B on an Enterprise Network	27
Connecting the E5810B to an Enterprise network	27

Configuring the E5810B for an Enterprise network operation	28
Connecting the E5810B to a Wireless Router	30
Verifying Instrument Communication	31
Find & Query Instruments page functions	32
Installing and Configuring Agilent IO Libraries Suite	33
Configuring a remote GPIB interface	35
Configuring a remote USB interface	36
Configuring a remote RS-232 serial interface	37
Verifying communication from the PC	39
Programming instruments	40
Addressing instruments using VISA and remote IO client	41
Addressing instruments using VISA and TCPIP interface	41
Addressing instruments with SICL	42

### **3 E5810B Web Access**

Web Browser	44
Welcome Page	45
Navigation bar	46
E5810B current settings	47
E5810B documentation links	48
E5810B support information banner	49
Viewing and Modifying the E5810B Configuration	50
Viewing the E5810B configuration	50
Modifying the E5810B configuration	51
Finding and Querying Instruments	61
Finding instruments	62
Querying instruments	64
Other Web Access Functions	67
Determining the session status	67

Web access help	68
Updating the E5810B firmware	69

## **4 Troubleshooting the E5810B**

Overview	84
Checking the E5810B	86
Checking the E5810B front panel display	86
Checking the E5810B LED indicators	87
Checking the E5810B parameters	88
Checking the Network	89
Checking the Web browser settings	90
Checking other network problems	92
Checking PC Client Connection	94
Verifying PC client connection	94
Checking the Syslog messages	95
Runtime error messages	98
Checking Connected Instruments	101

## **5 Characteristics and Specifications**

Technical Specifications	104
Supplementary Information	108
GPIB modes of operation supported	108
IEEE-488.1 and IEEE-488.2 compliance	108
Maximum number of simultaneous I/O connections	108
Supported Network Protocols	109

## **A Using the Telnet Utility**

Using the Telnet Utility	112
Telnet commands for E5810B	115

Telnet Command Comparison 117

## Glossary

- A 121
  - Address 121
  - ASRL 121
- B 121
  - Bridge 121
- C 122
  - Client 122
  - Controller 122
- D 122
  - Device 122
  - DHCP 123
  - DNS 123
- E 124
  - Ethernet (MAC) address 124
- F 124
  - Friendly name 124
- G 124
  - Gateway 124
  - Gateway IP address 125
- H 125
  - Hostname 125
  - Hub 125
- I 126
  - Instrument 126
  - Interface 126
  - IP address 127

L 128  
LAN 128  
Lock 129  
Logical unit 129

N 130  
Network protocols 130

P 131  
Proxy server 131

R 132  
Router 132  
RS-232 132

S 133  
Server 133  
SICL 133  
SRQ 133  
Subnet 134  
Subnet mask 134  
Switch 135  
Symbolic name 135

U 136  
Universal Plug and Play 136

V 137  
VEE 137  
VISA 137  
VISA COM 137

**THIS PAGE HAS BEEN INTENTIONALLY LEFT BLANK.**

## List of Figures

- Figure 1-1 E5810B front panel 2
- Figure 1-2 E5810B rear panel 4
- Figure 1-3 Direct PC connection 6
- Figure 1-4 Local network connection 7
- Figure 1-5 Enterprise network connection 8
- Figure 1-6 Client system architecture 11
- Figure 1-7 Typical network IP addressing 14
- Figure 1-8 Using the E5810B Web access 16
- Figure 1-9 E5810B Welcome page 17
- Figure 2-1 Installation flowchart 20
- Figure 2-2 E5810B LAN/GPIB/USB Gateway information 23
- Figure 2-3 Enterprise network information 23
- Figure 2-4 Connecting the E5810B to a local network via switch or hub 24
- Figure 2-5 Connecting the E5810B to a local network via a crossover cable 25
- Figure 2-6 Connecting the E5810B to an Enterprise network 27
- Figure 2-7 Connecting the E5810B to a wireless router 30
- Figure 2-8 Find and Control Instruments Connected to your E5810B page 31
- Figure 2-9 IO icon on the Windows taskbar notification area 34
- Figure 2-10 Remote GPIB interface dialog box 35
- Figure 2-11 Remote USB interface dialog box 36
- Figure 2-12 Remote RS-232 Serial interface dialog box 37
- Figure 2-13 Agilent Interactive IO 39
- Figure 3-1 E5810B Welcome page 45
- Figure 3-2 Navigation bar 46
- Figure 3-3 E5810B current settings 47
- Figure 3-4 E5810B documentation links 48
- Figure 3-5 E5810B support information banner 49
- Figure 3-6 Current Configuration of E5810B LAN/GPIB/USB Gateway page 50
- Figure 3-7 Configuring your E5810B LAN/GPIB/USB Gateway page 51
- Figure 3-8 Find and Control Instruments Connected to your

E5810B 61

- Figure 3-9 E5810B LAN/GPIB/USB Gateway Status page 67
- Figure 3-10 E5810B Web Access Help 68
- Figure 3-11 E5810B LAN/GPIB/USB Gateway dialog box 71
- Figure 3-12 Update firmware (via USB) message dialog box 72
- Figure 3-13 Error message dialog box 72
- Figure 3-14 E5810B LAN/GPIB/USB Gateway dialog box 74
- Figure 3-15 E5810B LAN/GPIB/USB Gateway dialog box (FTP) 74
- Figure 3-16 E5810B LAN/GPIB/USB Gateway dialog box 77
- Figure 3-17 E5810B LAN/GPIB/USB Gateway dialog box (FTP) 78
- Figure 4-1 Troubleshooting overview 84
- Figure 4-2 Typical Syslog display 95



## List of Tables

Table 1-1	E5810B default settings	5
Table 2-1	Enterprise network configuration parameters	29
Table 3-1	E5810B configuration parameters description	52
Table 3-2	Buttons description	65
Table 4-1	E5810B front panel display	86
Table 4-2	E5810B LED indicators	87
Table 4-3	Network configuration problems summary	89
Table 4-4	Common Syslog messages	96
Table 4-5	Typical Syslog messages	97
Table 4-6	Common runtime messages	98
Table 4-7	Checking GPIB, USB, and/or RS-232 interface instruments	101
Table 5-1	Supported network protocols	109
Table A-1	Telnet commands	115
Table A-2	Telnet command comparison	117

**THIS PAGE HAS BEEN INTENTIONALLY LEFT BLANK.**



# 1

## E5810B Description

E5810B Hardware Description	2
Typical network connections	6
E5810B front panel	2
E5810B rear panel	4
Default settings	5
E5810B Software/Firmware Descriptions	9
E5810B operating features	9
Typical network operation	10
Software/firmware architecture	11
Typical network IP addressing	13
Communicating with the E5810B	16

This chapter describes the E5810B hardware and software/firmware descriptions.



## E5810B Hardware Description

The E5810B provides a gateway between network-equipped computer systems and GPIB, USB, or RS-232-based instruments. This section provides an overview of the E5810B hardware.

### E5810B front panel

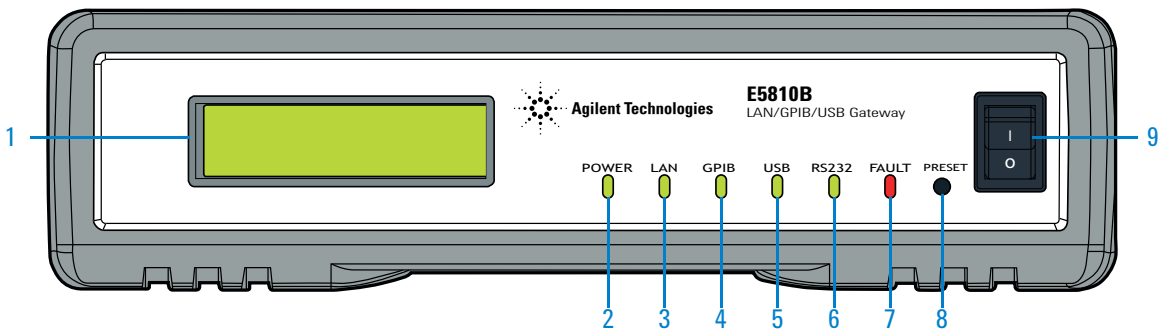

Figure 1-1 E5810B front panel

- 1 Front panel display**  
A 16-character, two-line display that displays the hostname, IP address, and system messages.
- 2 Power LED indicator**  
The LED (GREEN) turns on to indicate that there is AC power applied to the E5810B.
- 3 LAN LED indicator**  
The LED (GREEN) flashes to indicate that there is LAN connection activity.
- 4 GPIB LED indicator**  
The LED (GREEN) flashes to indicate that there is GPIB instrument activity.

5

**USB LED indicator**

The LED (GREEN) flashes to indicate that there is USB instrument activity.

6

**RS-232 LED indicator**

The LED (GREEN) flashes to indicate that there is RS-232 instrument activity.

7

**FAULT LED indicator**

The LED (RED) turns on at power-on while the E5810B is running a self-test.

If the LED turns on for more than 10 seconds and there is no IP address displayed on the front panel display, the E5810B may be experiencing hardware failure.

8

**Preset button**

Press this button for less than 10 seconds to temporarily reset the password to the default password (E5810).

Press this button for more than 10 seconds to return the E5810B to the factory default settings.

9

**Power ON/OFF switch**

Press this switch to turn on or off the E5810B.

## 1 E5810B Description

E5810B Hardware Description

### E5810B rear panel

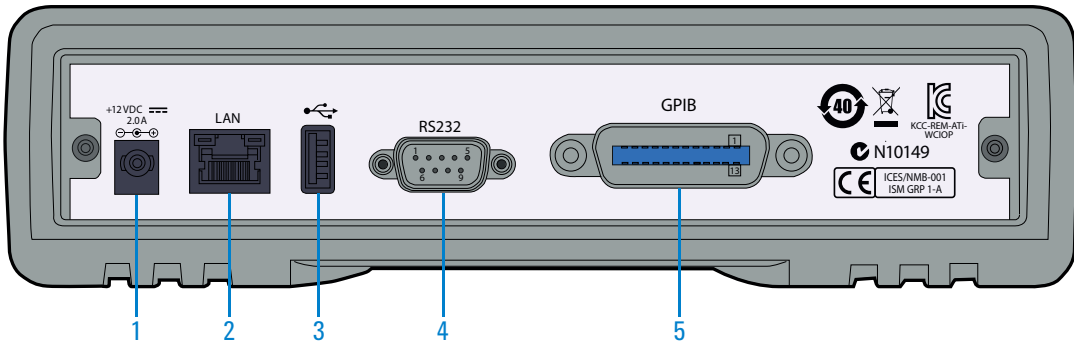

Figure 1-2 E5810B rear panel

1

#### DC power port

Connect the E5810B power adapter to this port.

2

#### LAN port

Connect one end of a LAN patch cable to this port and the other end to a router, switch, or hub for network connection. Connect one end of a LAN crossover cable to this port and the other end to a PC for direct PC connection.

3

#### USB port

Connect one end of a USB cable to this port and the other end to a USBTMC device.

4

#### RS-232 port

Connect one end of an RS-232 cable to this port and the other end to an RS-232 instrument.

5

#### GPIB port

Connect one end of a GPIB cable to this port and the other end to a GPIB instrument.

## Default settings

**Table 1-1** E5810B default settings

<b>Parameter</b>	<b>Default</b>	<b>Parameter</b>	<b>Default</b>
<b>DHCP</b>	ON	<b>GPIB Address</b>	21
<b>IP Address</b>	169.254.58.10	<b>GPIB Logical Unit</b>	7
<b>Subnet Mask</b>	255.255.0.0	<b>USB SICL Interface Name</b>	usb0
<b>Default Gateway</b>	0.0.0.0	<b>RS-232 SICL Interface Name</b>	COM1
<b>DNS Server(s)</b>	0.0.0.0	<b>RS-232 Baud Rate</b>	9600
<b>Hostname</b>	none	<b>RS-232 Parity</b>	NONE
<b>Description</b>	Agilent E5810B <MAC Address>	<b>RS-232 Bits</b>	8
<b>Universal Plug and Play</b>	ON	<b>RS-232 Stop Bits</b>	1
<b>LAN Keep Alive (s)</b>	7200 s	<b>RS-232 Flow Control</b>	NONE
<b>I/O Timeout (s)</b>	120 s	<b>RS-232 SRQ</b>	RI
<b>GPIB SICL Interface Name</b>	gpib0	<b>Password</b>	E5810

## Typical network connections

The E5810B can be connected directly to a PC, a local network, or an Enterprise network. Measurements can be obtained locally or remotely from GPIB, USB, or RS-232 instruments.

### Direct PC connection

For direct PC connection, a crossover LAN cable is connected from the E5810B LAN port to the PC. Only a PC can communicate with the E5810B in this connection.

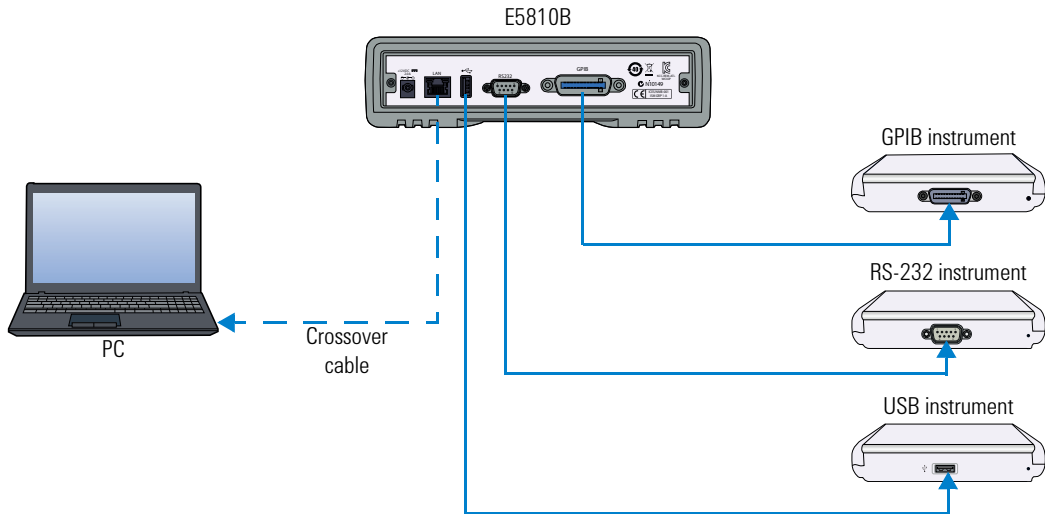
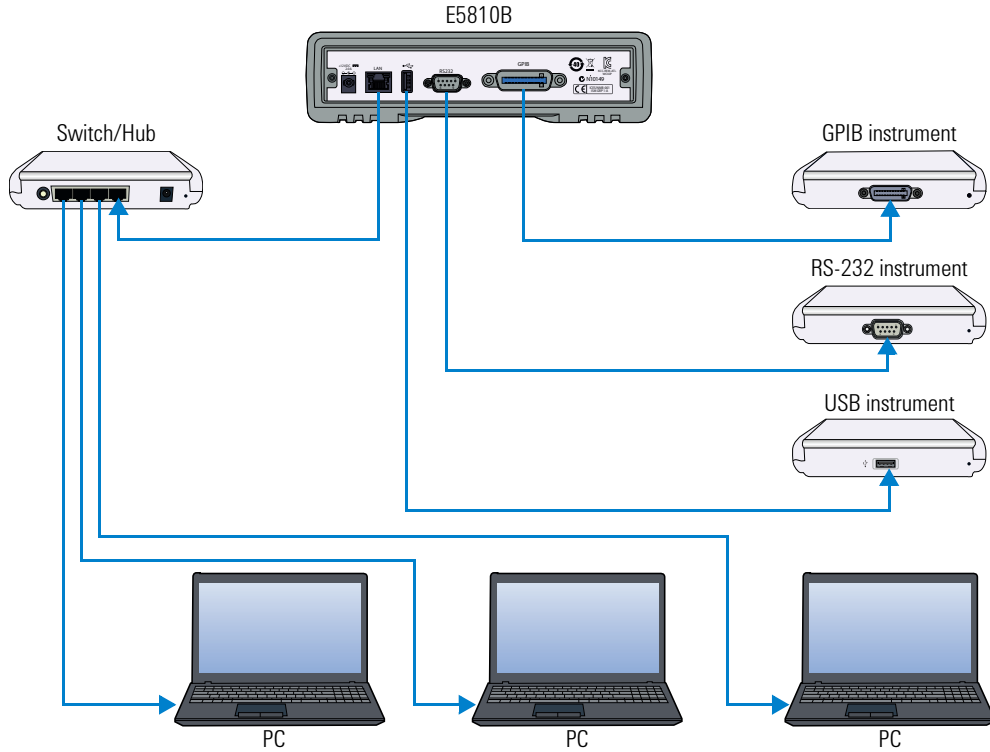

**Figure 1-3** Direct PC connection



### Local network connections

In a typical local network configuration, a switch or hub is used to connect to the network. Multiple PCs can communicate with the E5810B via the switch or hub.



**Figure 1-4** Local network connection

### Enterprise network connections

In a typical Enterprise network configuration, a router or switch is used to connect to the network.

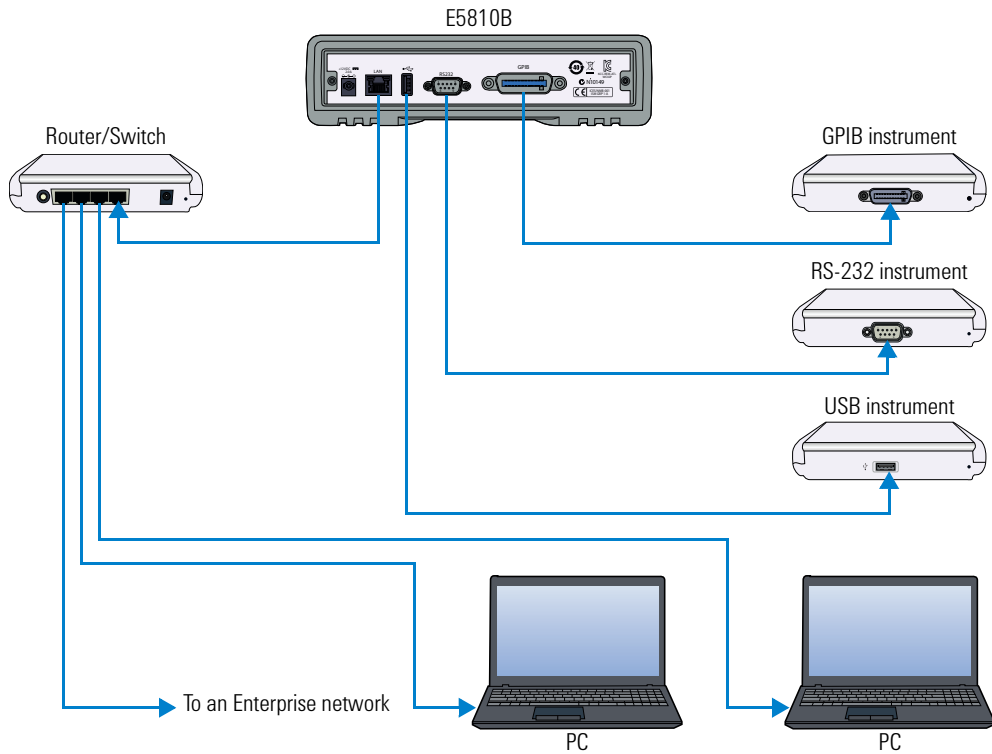

**Figure 1-5** Enterprise network connection

# E5810B Software/Firmware Descriptions

## E5810B operating features

### Remote access to connected instruments via LAN

The E5810B allows access and control of up to 14 GPIB instruments, 4 USB instruments via a self-powered hub, and one RS-232 instrument via a 10BASE-T/100BASE-TX/1000BASE-T Ethernet. The E5810B detects the network and configures itself to the appropriate speed. The E5810B has a standard RJ-45 LAN connector.

### I/O software

The E5810B includes the Agilent IO Libraries Suite, which includes Agilent Virtual Instrument Software Architecture (VISA), VISA COM, Standard Instrument Control Library (SICL), and several I/O utilities.

This standard software provides compatibility with different hardware and software vendors. It provides the I/O software layer used when accessing the E5810B. You can use a standard programming language, such as C/C++, Visual Basic, and Agilent VEE.

The E5810B supports all I/O application operations provided by VISA, VISA COM, SICL, and Agilent VEE. The E5810B is supported on Microsoft Windows XP, Windows Vista, Windows 7, Windows 8, Windows Server 2008 R2, and Windows Server 2012.

**Supports DHCP protocol**

The E5810B supports Dynamic Host Configuration Protocol (DHCP) to obtain the IP address. By default, DHCP is turned on. DHCP can be turned off and the E5810B can be assigned with a static IP address.

**Web access**

The E5810B is built in with Web access. The front panel display allows you to easily set up, configure, and use the E5810B. You can connect multiple E5810B in a test system. Each E5810B creates a separate GPIB bus.

**Typical network operation**

The E5810B enables you to obtain measurement data either locally or remotely from GPIB, USB, and RS-232 instruments. Refer to [“Typical network connections”](#) on page 6 for the typical connections to a PC, a local network, or an Enterprise network.

The E5810B connects a LAN from the computer system to the GPIB, USB, and RS-232 buses. Using the client-server model of computing, the computer system is the client, and the E5810B is the server.

Applications running on the computer system can transparently interface to the GPIB, USB, and RS-232-based instruments over the LAN. Since several computer systems can access the E5810B, groups of users can share access to the same GPIB, USB, and RS-232 instruments via the E5810B.

Existing I/O applications that are supported with the E5810B and are designed for GPIB, USB, and RS-232 instruments can be used with the E5810B without any modification other than changing the IP address.

The E5810B and the connected instruments can be placed anywhere on the network (rather than with a particular controller or a server computer system). This includes networks which span different geographic locations, such as when networked computer systems are located at several different sites.

GPIB, USB, and RS-232 instruments can be located where they are most convenient. You can also have more than one E5810B on a network, providing clusters of GPIB, USB, and RS-232 instruments at different locations.

## Software/firmware architecture

### Client system architecture

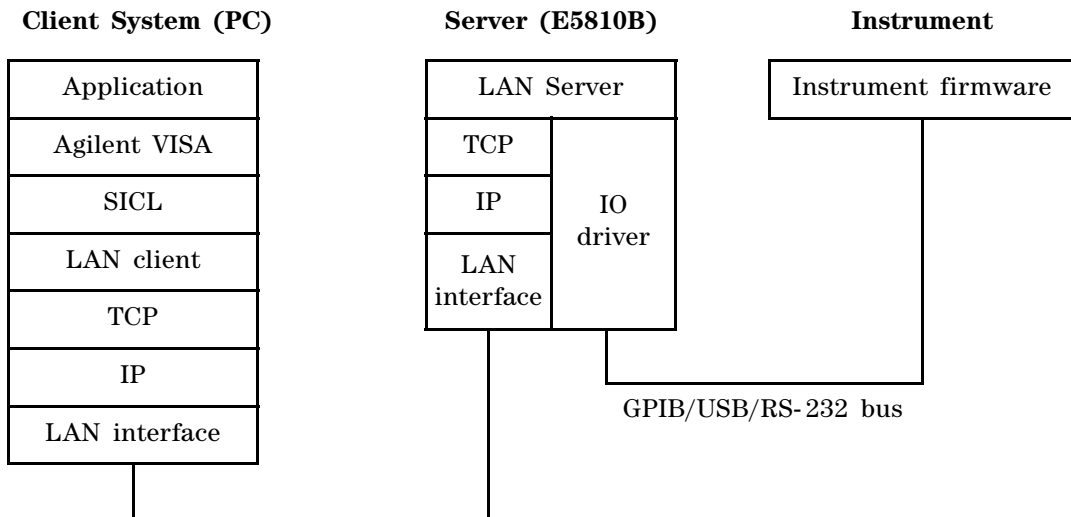

**Figure 1-6** Client system architecture

## 1 E5810B Description

### E5810B Software/Firmware Descriptions

The VISA LAN client software, and TCP/IP LAN software is needed on the client system (PC) to access the E5810B as shown in [Figure 1-6](#). The E5810B consists of the LAN server and TCP/IP LAN firmware, so that the E5810B can perform as the LAN server.

The VISA LAN client software is also known as the Remote IO Client software. It is part of Agilent IO Libraries Suite. The LAN server software is also called the Remote IO Server software.

The VISA LAN client software uses the TCP/IP LAN protocol suite to pass messages between the client system and the server (E5810B). The client sends I/O requests over the network to the server. The server will execute those I/O requests on the appropriate GPIB, USB, and RS-232-based instruments connected to the server.

### **I/O application operation**

Before performing an I/O application operation on the E5810B GPIB, USB, or RS-232 interface and the GPIB, USB, or RS-232 bus, the Remote IO Client software in the client computer system must establish a network connection to the remote I/O server (E5810B). Once the client establishes a connection, the client can begin to send I/O requests to the E5810B.

The E5810B (remote I/O server) allows multiple clients to be connected and serviced at any given time. The maximum number of concurrent client connections depends on the memory usage in the E5810B, including the number of clients and current sessions running on those clients. However, the E5810B only allows up to 16 client connections to be run concurrently.

If the maximum number of client connections to the E5810B has not been exceeded, the connection is allowed. Although several instruments can be connected to the E5810B GPIB bus, only one I/O application operation can be performed on the GPIB bus at any given time. Therefore, once a client's request begins to execute on the GPIB, all other client requests for operations on the GPIB must wait until the current client request completes. Client requests are serviced in a first come, first served manner, unless they are prohibited by the interface or the device locks.

If a client has a sequence of I/O application operations to perform that should not be preempted, the client should obtain a lock on the E5810B GPIB, USB, or RS-232 interface or device. Once the client's sequence is completed, it should release its lock, allowing access for other clients.

When a client closes a connection, the E5810B frees up the resources allocated to that client, including any locks, pending I/O requests, and memory usage.

## Typical network IP addressing

This section describes the typical Enterprise network IP addresses and subnet addresses on the network. [Figure 1-7](#) shows a typical Enterprise network, consisting of a router (gateway), a corporate Dynamic Host Configuration Protocol (DHCP) server, and a subnet consisting of six hosts (two E5810Bs and four host PCs). The router sends packets of information to each host, based on the IP address of the host. The subnet is defined by the Subnet Mask for the IP addresses on the subnet.

# 1 E5810B Description

E5810B Software/Firmware Descriptions

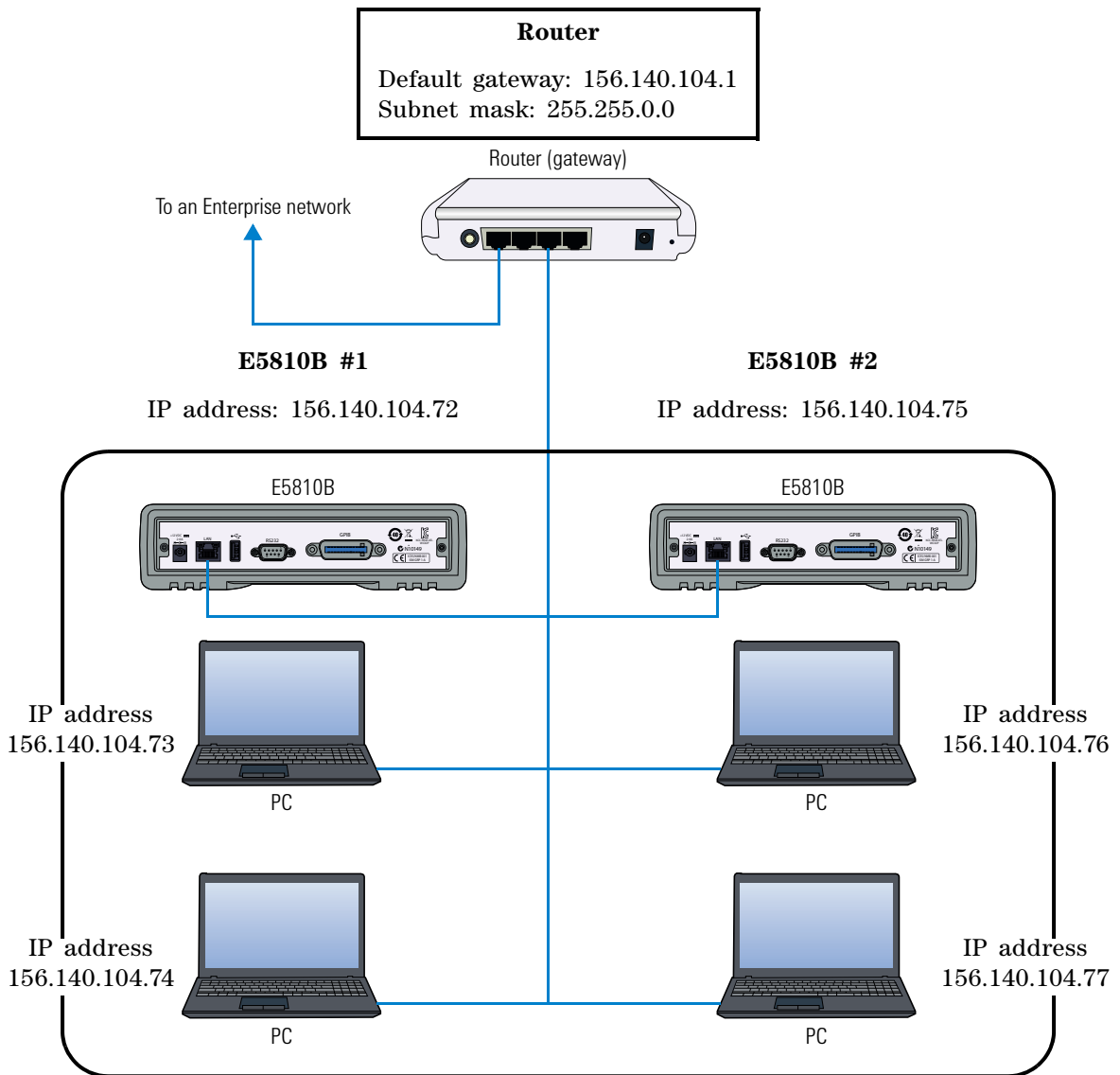

Figure 1-7 Typical network IP addressing



## Subnet addressing

A Subnet Mask is used to determine to which subnet an IP address belongs. An IP address has two components: the network address and the host address. For example, the IP address 156.215.117.109 is part of a Class B network. The first two numbers (156.215) represent the Class B network address and the second two numbers (117.109) identify a specific host on this network. Refer to “Glossary” on page 119 for more information on the Class B network.

For the subnet as shown in [Figure 1-7](#), the IP address for E5810B #1 is 156.140.104.72, where 156.140 represents the network address and 104.72 represents the E5810B #1 host address. The IP address for E5810B #2 is 156.140.104.75, where 156.140 represents the network address and 104.75 represents the E5810B #2 host address.

## IP address assignment

For the E5810B to operate on an Enterprise network, three addresses must be identified – E5810B IP Address, Subnet Mask, and Default Gateway Address.

If the Enterprise network supports Dynamic Host Configuration Protocol (DHCP), the E5810B will automatically receive an IP address, Subnet Mask, and Default Gateway from the DHCP server. If the network does not support DHCP, the E5810B IP address must be configured manually.

If the network supports Domain Name Service (DNS), the E5810B hostname can be configured. This can be done in two methods.

- The DNS server IP Address is provided by the DHCP server (this is transparent to the user).
- A DNS server IP address is supplied by the system administrator and entered on the Configuring your E5810B LAN/GPIB/USB Gateway page.

## Communicating with the E5810B

There are two methods to communicate with the E5810B via a network – E5810B Web access or a supported programming language with Agilent IO Libraries Suite.

### Using the E5810B Web access

**Agilent IO Libraries Suite is not required**

The E5810B provides a Web server that allows access via the Web.

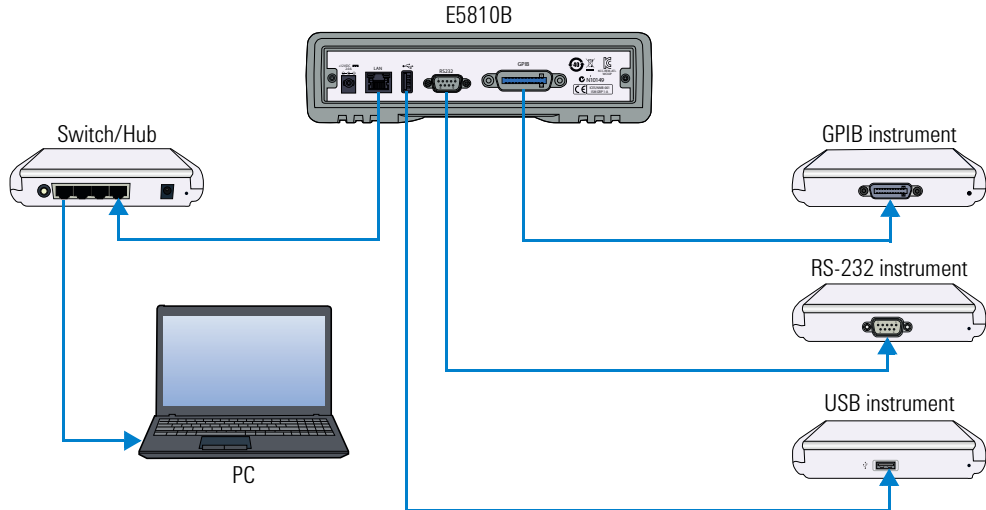

Use a supported Web browser to access and configure the E5810B.

Instruments are programmed using standard instrument commands (such as SCPI) via the Web browser.

**Figure 1-8** Using the E5810B Web access

The E5810B is Web-enabled, so you can communicate with the E5810B from a supported Web browser. The E5810B supports Internet Explorer 6 or greater (Internet Explorer 7 or greater is recommended for Windows Vista, Windows 7, Windows 8, Windows Server 2008 R2, and Windows Server 2012).

To display the E5810B Welcome page, go to your Web browser and type `http://<hostname>` (if known) or `http://<IP address>` at the address line.

You can use the Web access to configure the E5810B and to communicate with the GPIB, USB, and RS-232 instruments. For example, from the Configuring your E5810B LAN/GPIB/USB Gateway page of the E5810B interface, you can view and modify the configuration of the E5810B. You can also communicate with the installed GPIB, USB, and RS-232 instruments using the Find and Control Instruments Connected to your E5810B page. Refer to [Chapter 3](#), “E5810B Web Access” for more information on the E5810B Web access.

Agilent Technologies

E5810B LAN/GPIB/USB Gateway

[Support](#) | [Products](#) | [Agilent Site](#)

Another web-enabled product  
from Agilent Technologies

---

 Welcome Page

 View & Modify Configuration

 Find & Query Instruments

 Session Status

 Print Page

 Help with this Page

Welcome to your

## Web-Enabled E5810B LAN/GPIB/USB Gateway

Use the Navigation Bar on the left to access your E5810B

Your Current Settings are:

<b>Ethernet (MAC) Address:</b>	44:E8:A5:00:01:21
<b>Hostname:</b>	<i>Not Known</i>
<b>IP Address:</b>	141.183.191.227
<b>GPIB SICL Interface Name:</b>	gpib0
<b>USB SICL Interface Name:</b>	usb0
<b>RS-232 SICL Interface Name:</b>	COM1
<b>Firmware Revision:</b>	E5810B_20121106_R001_STAND
<b>Serial Number:</b>	MY50360021



Supporting your I/O needs

---

**E5810B Documentation:**

- [Help](#)
- [User's Guide](#)

**Figure 1-9** E5810B Welcome page

### **Using supported programming language**

To use applications that require the Agilent IO Libraries, you must install and configure the Agilent IO Libraries Suite on each PC to be used for programming. You can then program the connected instruments using a supported programming language, such as C/C++ or Visual Basic using Agilent Virtual Instrument Software Architecture (VISA), VISA COM, or Standard Instrument Control Language (SICL).

Refer to the *Agilent IO Libraries Suite Quick Start Guide* and *Agilent IO Libraries Suite Help* for more information on the Agilent IO Libraries Suite.



## 2 Installing the E5810B

Installation Flowchart	20
Before Installing the E5810B	21
Check your PC	21
Rack mount the E5810B (optional)	21
E5810B related documentation	21
Getting Network Information	22
Local network information	22
Enterprise network information	22
Configuring the E5810B on a Local Network	24
Connecting the E5810B to a local network	24
Configuring the E5810B for a local network operation	26
Configuring the E5810B on an Enterprise Network	27
Connecting the E5810B to an Enterprise network	27
Configuring the E5810B for an Enterprise network operation	28
Connecting the E5810B to a Wireless Router	30
Verifying Instrument Communication	31
Find & Query Instruments page functions	32
Installing and Configuring Agilent IO Libraries Suite	33
Configuring a remote GPIB interface	35
Configuring a remote USB interface	36
Configuring a remote RS-232 serial interface	37
Verifying communication from the PC	39
Programming instruments	40
Addressing instruments using VISA and remote IO client	41
Addressing instruments using VISA and TCPIP interface	41
Addressing instruments with SICL	42

This chapter shows you the steps to install the E5810B LAN/GPIB/USB gateway.



## Installation Flowchart

Figure 2-1 shows the installation flowchart to install and configure the E5810B on an Enterprise network or local network.

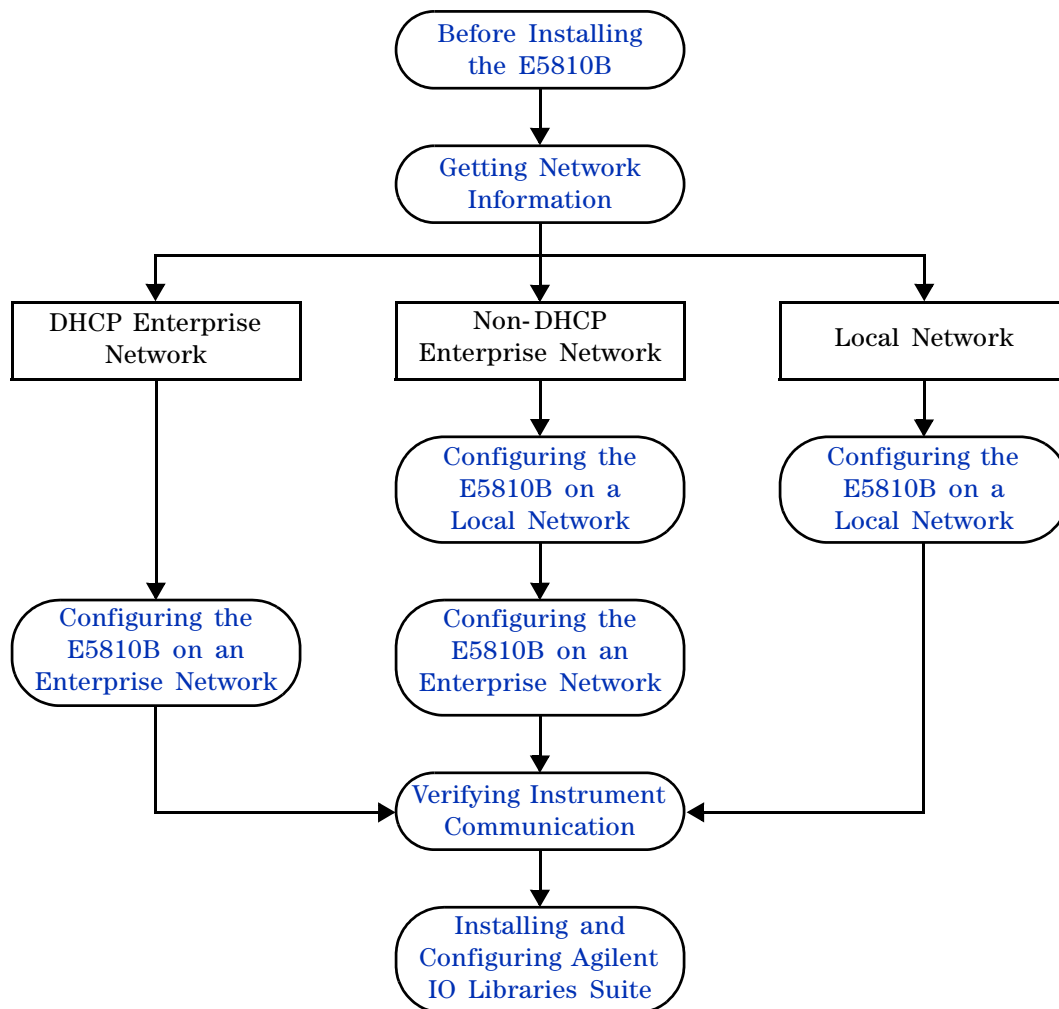

Figure 2-1 Installation flowchart

## Before Installing the E5810B

### Check your PC

The E5810B is supported on the following operating systems.

- Windows XP
- Windows Vista
- Windows 7
- Windows 8
- Windows Server 2008 R2
- Windows Server 2012

To communicate with the E5810B, Microsoft Internet Explorer 6 or greater is required (Internet Explorer 7 or greater is recommended for Windows Vista, Windows 7, Windows 8, and Windows Server 2008 R2).

### Rack mount the E5810B (optional)

You can mount the E5810B on a standard EIA rack using the Rack Mount Kit (E5810-00100) or equivalent. The E5810B is one standard half-rack unit wide and one standard rack unit high. Refer to the *Rack Mount Installation Note* for more information.

### E5810B related documentation<sup>[1]</sup>

- *Agilent IO Libraries Suite Quick Start Guide* provides a description of the Agilent IO Libraries Suite.
- *Agilent IO Libraries Suite Help* provides detailed usage information on the Agilent IO Libraries Suite.
- *Agilent VISA Help* describes the Agilent Virtual Instrument Software Architecture (VISA) library.
- *Agilent SICL Help* describes the Agilent Standard Instrument Control Library (SICL) for Windows.

[1] Click the IO icon on the Windows taskbar notification area and select **Documentation** to obtain the related documentation.

## Getting Network Information

### Local network information

Before you connect the E5810B to a local network, you will need the required network information, such as the IP addresses. You do not need to obtain any system information from the system administrator in your IT department.

### Enterprise network information

Before you connect the E5810B to an Enterprise network, you will need to get some network configuration and network addressing parameters from the system administrator in your IT department.

Before contacting the system administrator, obtain the E5810B serial number and Ethernet (MAC) address printed on a label at the bottom panel of the E5810B. Fill up the information in the **E5810B LAN/GPIB/USB Gateway Information** as shown in [Figure 2-2](#).

After you have filled up the information, provide this information to your system administrator and request for the Enterprise network information as shown in [Figure 2-3](#).



E5810B LAN/GPIB/USB Gateway Information	
Serial number:	_____
Ethernet (MAC) address:	_____
Default values (for system administrator)	<b>DHCP:</b> Enabled at power-on <b>Hostname:</b> No hostname configured

Figure 2-2 E5810B LAN/GPIB/USB Gateway information

Enterprise Network Information	
Does the network support DHCP?	Yes ____ No ____
If No, provide –	<b>IP address (static):</b> _____
	<b>Subnet mask:</b> _____
	<b>Gateway IP address:</b> _____
Does the network support DNS?	Yes ____ No ____
If Yes, provide –	<b>E5810B hostname:</b> _____
	<b>DNS server (IP address)</b> _____

Figure 2-3 Enterprise network information

## 2 Installing the E5810B

Configuring the E5810B on a Local Network

# Configuring the E5810B on a Local Network

### NOTE

If you are configuring the E5810B on a DHCP Enterprise network, refer to “Configuring the E5810B on an Enterprise Network” on page 27.

## Connecting the E5810B to a local network

### Switch or Hub connections

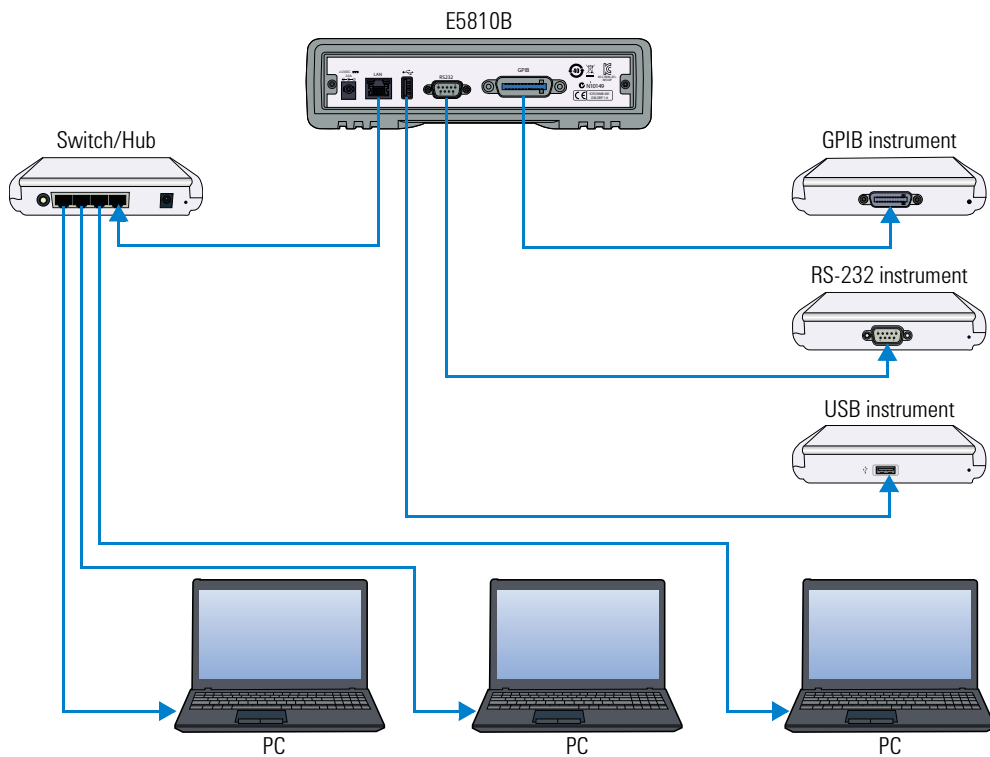

**Figure 2-4** Connecting the E5810B to a local network via switch or hub

### Crossover cable connections

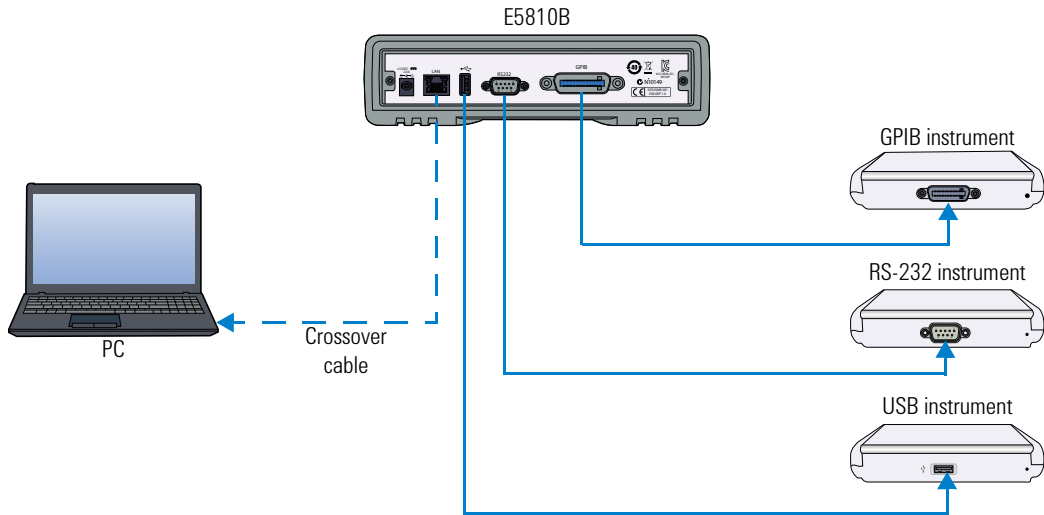

**Figure 2-5** Connecting the E5810B to a local network via a crossover cable

Turn on the E5810B and the IP address will be displayed on the front panel display.

#### NOTE

- The E5810B may require up to 75 seconds to display the default static IP address (169.254.58.10) as it will try to find a DHCP server until a timeout value is reached.
- If you try to simultaneously attach multiple E5810Bs without changing each unit's default static IP address, some E5810Bs may not be able to start operation. The E5810B detects duplicated IP addresses and will not start operation if the IP address is already in use.
- To prevent this, add a E5810B at a time and configure the E5810B to a unique IP address before adding the additional E5810Bs.

## 2 Installing the E5810B

### Configuring the E5810B on a Local Network

## Configuring the E5810B for a local network operation

This section provides the guidelines to configure the E5810B on a local network or eventual installation on a non-DHCP Enterprise network.

The first step in configuring the E5810B on a local network is to establish communication between your PC and the E5810B. The PC and the E5810B must be on the same subnet in order to establish a connection.

To place the PC and the E5810B on the same subnet, type in `route add <E5810B IP address> <PC IP address>` in the **MS-DOS prompt** program.

For example, if the PC IP address is 155.139.103.152 and the E5810B IP address is 169.254.58.10 (default), the commands are as follows:

```
!route is lost when the PC is rebooted  
route add 169.254.58.10 155.139.103.152
```

or

```
!route persists when the PC is rebooted  
route -p add 169.254.58.10 155.139.103.152
```

After the connection is established, you can set the required configuration parameters using the E5810B Web access.

### NOTE

Refer to [Chapter 3](#), “E5810B Web Access” for more information in configuring the E5810B parameters using the E5810B Web access.

## Configuring the E5810B on an Enterprise Network

**NOTE**

If you are configuring the E5810B on a non-DHCP Enterprise network, refer to “[Configuring the E5810B on a Local Network](#)” on page 24 before proceeding.

### Connecting the E5810B to an Enterprise network

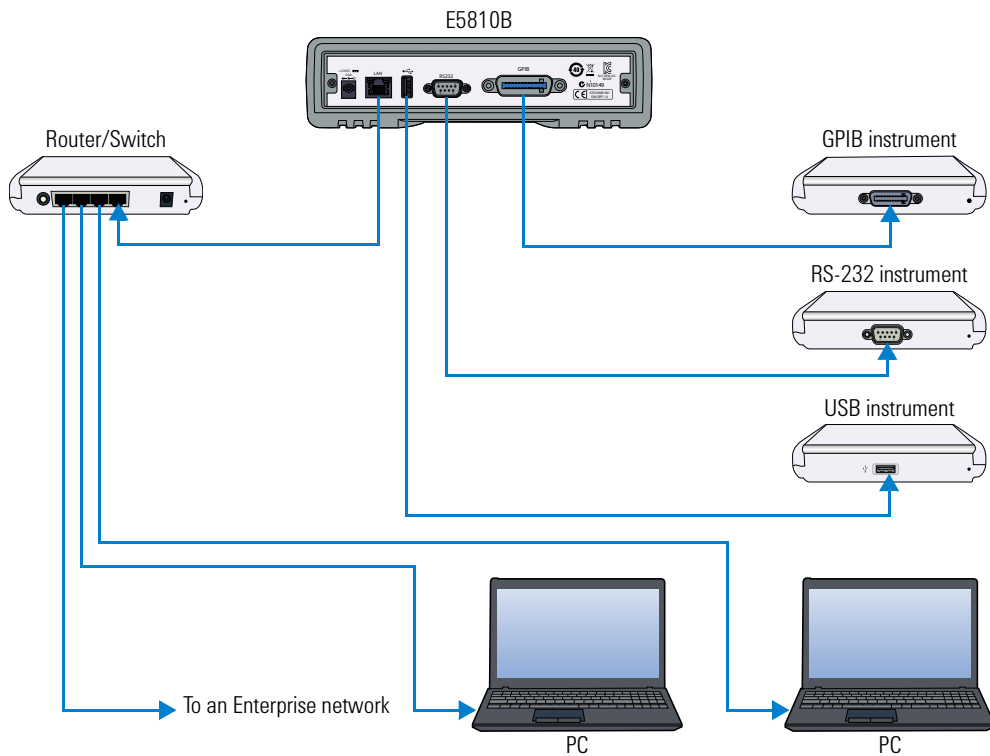

**Figure 2-6** Connecting the E5810B to an Enterprise network

Turn on the E5810B and the IP address will be displayed on the front panel display.

### Configuring the E5810B for an Enterprise network operation

After the E5810B is installed on the Enterprise network, you can set the required configuration parameters using the E5810B Web access.

#### NOTE

Refer to [Chapter 3](#), “E5810B Web Access” for more information in configuring the E5810B parameters using the E5810B Web access.

- 1 Go to your Web browser and type `http://<hostname>` (if known) or `http://<IP address>` at the address line.
- 2 Select **View & Modify Configuration** from the E5810B Welcome page to display the E5810B current configuration.
- 3 Select **Modify Configuration** and enter the password to configure the E5810B. The default password is E5810.
- 4 The Configuring your E5810B LAN/GPIB/USB Gateway page will be displayed.
- 5 To configure the E5810B for use on an Enterprise network operation, refer to [Table 2-1](#) for the required configuration parameters.

**Table 2-1** Enterprise network configuration parameters

IP ADDRESS ASSIGNMENT	
<p><b>DHCP Enterprise network</b></p> <p>No action is required. The E5810B automatically receives an IP address from the network DHCP server.</p>	<p><b>Non-DHCP Enterprise network</b></p> <p>Set the DHCP setting to <b>OFF</b>, and update the IP Address, Subnet Mask, and Default Gateway with the parameters provided by your system administrator in “<a href="#">Enterprise network information</a>” on page 22.</p>
HOSTNAME	
<p><b>DNS Enterprise network</b></p> <ul style="list-style-type: none"> <li>• If the network supports dynamic DNS, enter the hostname provided by the system administrator. You can now access the E5810B from your Web browser by using the hostname.</li> <li>• If the network supports DNS, enter the DNS server IP address provided by the system administrator.</li> </ul>	<p><b>Non-DNS Enterprise network</b></p> <p>No action is required. Hostnames are not supported. Only IP address can be used to communicate with the E5810B.</p>
UNIVERSAL PLUG AND PLAY (UPnP)	
<p><b>UPnP is allowed on the Enterprise network</b></p> <p>No action is required. However, if you want the E5810B to be displayed in <b>My Network Places</b>, enable UPnP in your operating system.</p>	<p><b>UPnP is not allowed on the Enterprise Network or you do not want the E5810B to be displayed in My Network Places</b></p> <p>Disable UPnP in your operating system.</p>

## 2 Installing the E5810B

Connecting the E5810B to a Wireless Router

### Connecting the E5810B to a Wireless Router

The E5810B supports wireless router connection. This means that you can connect multiple PCs to the E5810B wirelessly. Refer to [Figure 2-7](#) for more information.

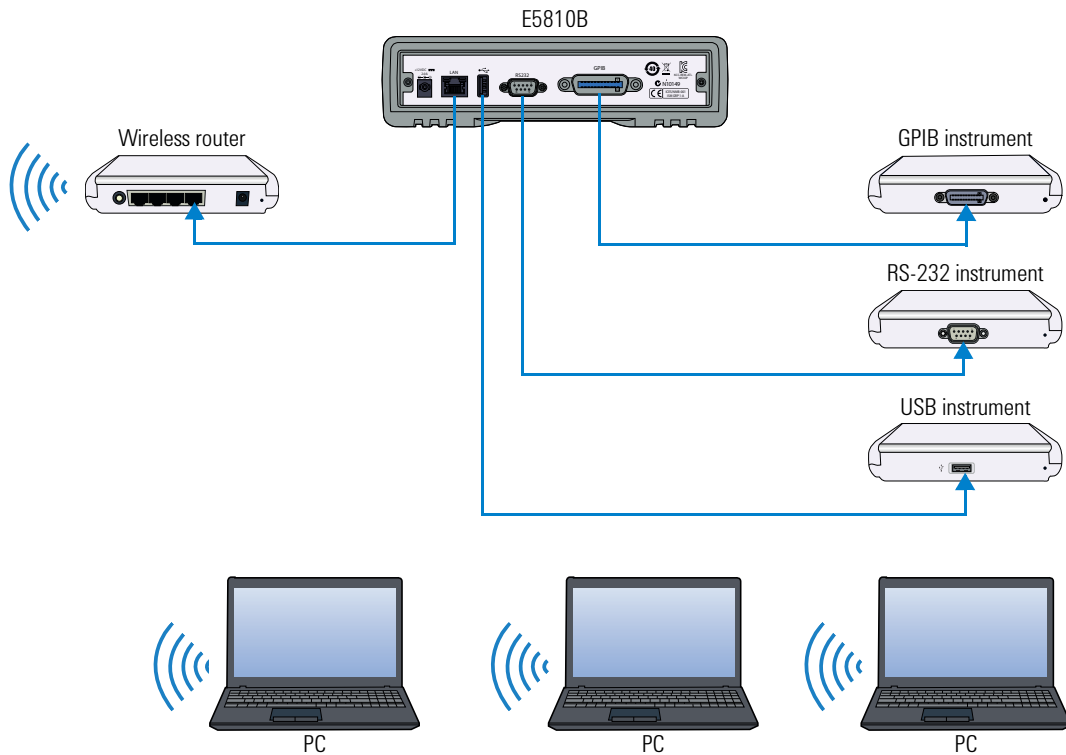

**Figure 2-7** Connecting the E5810B to a wireless router



## Verifying Instrument Communication

Select **Find & Query Instruments** from the E5810B Welcome page and enter the password to verify instrument communication from the E5810B. The default password is E5810.

### NOTE

Refer to [Chapter 3](#), “E5810B Web Access” for more information in configuring the E5810B parameters using the E5810B Web access.

The screenshot displays the E5810B LAN/GPIB/USB Gateway web interface. The page title is "Find and Control Instruments Connected to your E5810B LAN/GPIB/USB Gateway". The interface is divided into two main sections: "Instruments Connected" and "Control Panel for Selected Instrument".

**Instruments Connected (SICL Addresses):**

- COM1.488
- gpi0.3
- usb0[2391::1031::MY4402606::1]

A "Find" button is located at the bottom of this section.

**Control Panel for Selected Instrument:**

- Timeout (sec): 2
- Buttons: Device Clear, \*IDN?, Clear History, Read STB, SYST:ERR?
- Instrument Command input field with Send, Receive, and Query buttons.
- Clear ALL Pending Operations button (highlighted in red).

The left sidebar contains navigation links: Welcome Page, View & Modify Configuration, Find & Query Instruments (selected), Session Status, Print Page, and Help with this Page. The top navigation bar includes Support, Products, and Agilent Site links, along with a badge stating "Another web-enabled product from Agilent technologies".

**Figure 2-8** Find and Control Instruments Connected to your E5810B page

# Find & Query Instruments page functions

## Checking instrument communication

- 1 Select the SICL address of the connected instrument to be addressed. The selected SICL address will be highlighted.
- 2 Depending on the instrument selected, you can select the predefined queries button – **Device Clear**, **\*IDN?**, **Read STB**, or **SYS:ERR?** to communicate with the instrument.

## Sending commands or queries

- 1 You can send instrument-specific commands to applicable instruments using the **Instrument Command** line.
- 2 Select **Send**, **Receive**, or **Query** as required.

## Other functions

- 1 Select **Clear History** to clear the responses displayed on the Find and Control Instruments Connected to your E5810B page.
- 2 You can also set the timeout value (in seconds) by typing in the desired value in the **Timeout (sec)** box.
- 3 Select **Clear ALL Pending Operations** to clear all pending operations on the instruments connected to the E5810B.

# Installing and Configuring Agilent IO Libraries Suite

**NOTE**

You must have Administrator privileges to install Agilent IO Libraries Suite Connection Expert.

This section describes how to install Agilent IO Libraries Suite on your PC. The Agilent IO Libraries Suite is a collection of libraries and utilities that gives you the ability to use your instruments from the instrument control software.

You should install the Agilent IO Libraries Suite as your first step before installing the hardware because it installs the necessary software and drivers to control your instruments.

If possible, always use the most recent version of the Agilent IO Libraries Suite. This version supports the newest interfaces and operating systems, and has the most advanced features.

- 1 Verify that your PC meets the minimum system requirements. Refer to the IO Libraries Web page at [www.agilent.com/find/iosuite](http://www.agilent.com/find/iosuite) or the IO Libraries Suite Readme.
- 2 Close all applications on your computer. Insert the Agilent Automation-Ready CD in your CD-ROM drive or download and install the IO Libraries software from [www.agilent.com/find/iosuite](http://www.agilent.com/find/iosuite).
- 3 Follow the instructions as prompted during the installation. You can select either a Typical or a Custom installation:

**Typical**

In most cases, you can select the Typical installation which installs the IO Libraries Suite using the recommended settings.

## 2 Installing the E5810B

### Installing and Configuring Agilent IO Libraries Suite

#### Custom

Select the Custom installation to:

- i Install the IO Libraries Suite in another directory (for 32-bit operating systems only).
  - ii Save disk space by not installing interface manuals.
  - iii Use Agilent 32-bit VISA with another vendor's VISA on the same PC in side-by-side mode. Details on the side-by-side mode are available at [www.agilent.com/find/side-by-side-install](http://www.agilent.com/find/side-by-side-install) or in the IO Libraries Suite help.
- 4 After the IO Libraries suite is successfully installed, you will see the IO icon on the Windows taskbar notification area.

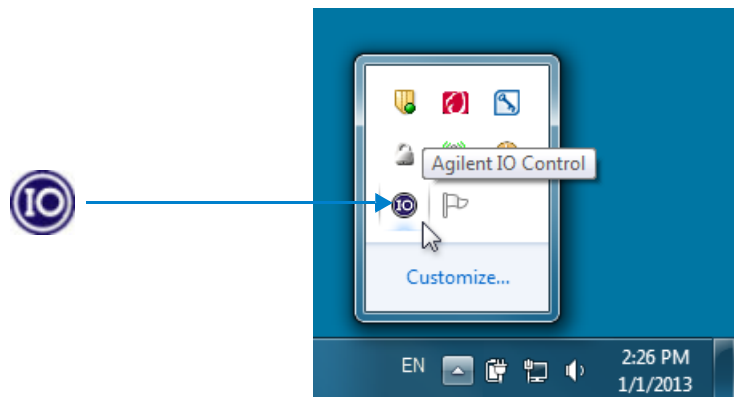

**Figure 2-9** IO icon on the Windows taskbar notification area

## Configuring a remote GPIB interface

- 1 Launch **Agilent Connection Expert** from the Start menu or the Start Screen (Windows 8).
- 2 Select **Add interface** on the **Agilent Connection Expert** toolbar.
- 3 In the Manually Add an Interface dialog box, select **Remote GPIB**.
- 4 Select **Add** to display the Remote GPIB interface dialog box as shown in [Figure 2-10](#).

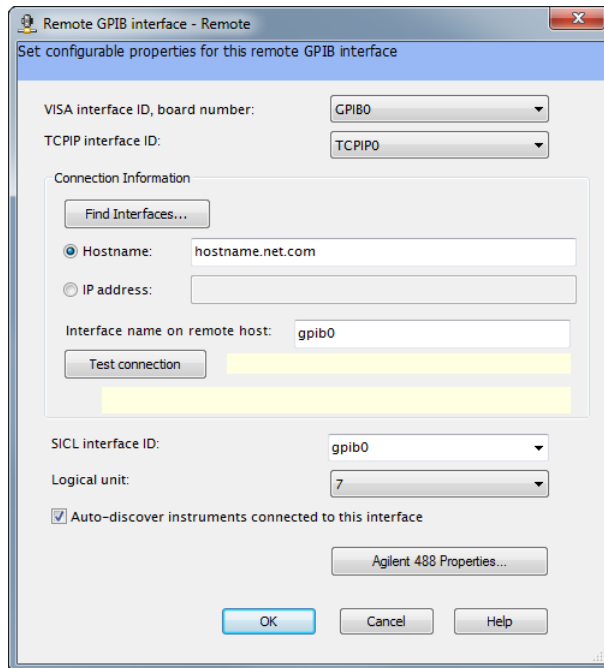

**Figure 2-10** Remote GPIB interface dialog box

- 5 If the E5810B is in the subnet as the PC, select **Find Interfaces...** to locate and add the remote GPIB interface.
- 6 If the E5810B is on a different subnet from the PC, enter the hostname or the IP address displayed on the E5810B front panel display.

## 2 Installing the E5810B

### Installing and Configuring Agilent IO Libraries Suite

- 7 Update the value in the **Interface name on remote host:** field, if necessary, to match the **GPIB SICL Interface Name** displayed on the E5810B Welcome page.
- 8 Select **Test connection** to verify the connectivity and configuration of the remote GPIB interface.

## Configuring a remote USB interface

- 1 Launch **Agilent Connection Expert** from the Start menu or the Start Screen (Windows 8).
- 2 Select **Add interface** on the **Agilent Connection Expert** toolbar.
- 3 In the Manually Add an Interface dialog box, select **Remote USB**.
- 4 Select **Add** to display the Remote USB interface dialog box as shown in [Figure 2-11](#).

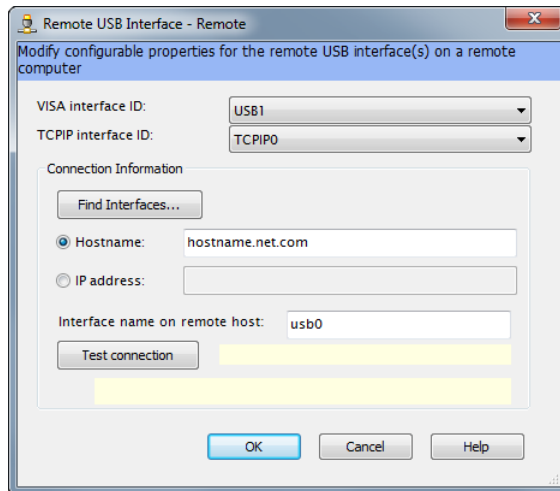

**Figure 2-11** Remote USB interface dialog box

- 5 If the E5810B is in the subnet as the PC, select **Find Interfaces...** to locate and add the remote USB interface.

- 6 If the E5810B is on a different subnet from the PC, enter the hostname or the IP address displayed on the E5810B front panel display.
- 7 Update the value in the **Interface name on remote host:** field, if necessary, to match the **USB SICL Interface Name** displayed on the E5810B Welcome page.
- 8 Select **Test connection** to verify the connectivity and configuration of the remote USB interface.

## Configuring a remote RS-232 serial interface

- 1 Launch **Agilent Connection Expert** from the Start menu or the Start Screen (Windows 8).
- 2 Select **Add interface** on the **Agilent Connection Expert** toolbar.
- 3 In the Manually Add an Interface dialog box, select **Remote RS-232**.
- 4 Select **Add** to display the Remote RS-232 Serial interface dialog box as shown in [Figure 2-12](#).

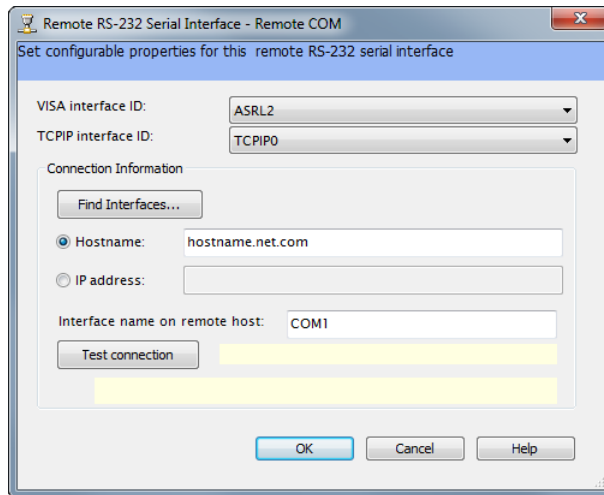

**Figure 2-12** Remote RS-232 Serial interface dialog box

## 2 Installing the E5810B

### Installing and Configuring Agilent IO Libraries Suite

- 5 If the E5810B is in the subnet as the PC, select **Find Interfaces...** to locate and add the remote RS-232 interface.
- 6 If the E5810B is on a different subnet from the PC, enter the hostname or the IP address displayed on the E5810B front panel display.
- 7 Update the value in the **Interface name on remote host:** field, if necessary, to match the **RS-232 SICL Interface Name** displayed on the E5810B Welcome page.
- 8 Select **Test connection** to verify the connectivity and configuration of the remote RS-232 interface.
- 9 To establish communication with an RS-232 serial instrument connected to your E5810B, you will need to add this instrument manually as Agilent Connection Expert is not able to auto-discover serial devices.
- 10 Select **Add instrument** on the **Agilent Connection Expert** toolbar.
- 11 In the Add instrument dialog box, select the remote RS-232 serial interface that you have just added.
- 12 The remote RS-232 serial interface will appear on the Agilent Connection Expert.



## Verifying communication from the PC

After you have configured the remote interface instruments, verify the communication between the PC and the remote interface instruments by using Agilent Interactive IO.

### NOTE

You can also verify the communication between the PC and the remote interface instruments using the E5810B Web access as shown in [“Verifying Instrument Communication”](#) on page 31.

- 1 Launch **Agilent Connection Expert** from the Start menu or the Start Screen (Windows 8).
- 2 Right-click on the remote interface instrument and select **Send Commands To This Instrument** to display the **Agilent Interactive IO** dialog box.
- 3 Use the default command, **\*IDN?** and select **Send & Read** to query the connected instrument.
- 4 The remote interface instrument identification information will appear on the **Instrument Session History** as shown in [Figure 2-13](#).
- 5 To send other commands, select **Commands>** to select from a list of common commands, or type a command into the **Command:** line.

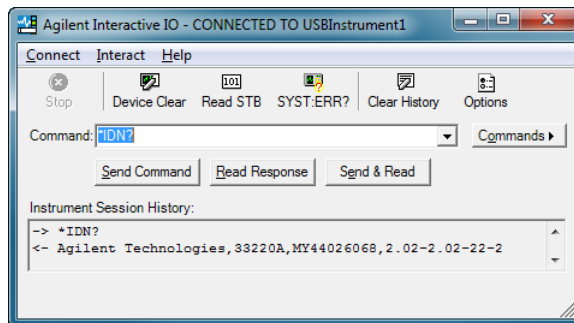

Figure 2-13 Agilent Interactive IO

## Programming instruments

After the communication between the PC and the remote interface instruments is established, you can program the remote interface instruments using Agilent VISA, VISA COM, or SICL to send instrument commands such as SCPI.

You can also program in various languages or applications, including Visual Studio .NET languages, Visual Basic, Visual C++, Agilent VEE, and National Instruments LabVIEW.

For general programming guidelines, refer to the documentation for your programming environment. You can also find programming examples using various I/O libraries and instrument drivers in the instrument's *User's Guide*. After the E5810B is successfully installed and configured, it should act as a transparent interface for programming GPIB, USB, and RS-232 instruments.

For more information on programming using Agilent VISA, VISA COM, or SICL, refer to the respective instrument's *User's Guide*. You can also refer to *Agilent Connectivity Guide* and *Agilent IO Libraries Suite Help* for further information and guidelines on programming with Agilent IO Libraries.

These documents can be obtained by clicking the IO icon on the Windows taskbar notification area and selecting **Documentation**.

## Addressing instruments using VISA and remote IO client

After you have created a remote GPIB, remote USB, or remote serial interface in Agilent Connection Expert, you can use ordinary GPIB, USB, or serial addressing in your VISA or VISA COM programs to address instruments on these interfaces.

The Remote IO Client software maps the TCPIP address requests into the appropriate interface type (GPIB or ASRL) addresses. Thus, the IP address and hostname of the E5810B do not appear in the instrument address. This makes it possible to use existing programs written for GPIB or ASRL without modifying code.

After the remote interface instruments are configured, VISA programs can then use addresses such as GPIB0::22::INSTR (for GPIB), USB::INSTR (for USB), or ASRL1::INSTR (for RS-232). Use these addresses in your viOpen() call as follows:

```
viOpen (... "GPIB0::22::INSTR" ...)  
viOpen (... "USB0::INSTR" ...)  
viOpen (... "ASRL1::INSTR" ...)
```

## Addressing instruments using VISA and TCPIP interface

Although remote GPIB, remote USB, and remote serial interfaces are the most convenient ways to configure and program instruments on your E5810B, you may choose not to use them. For example, if you are using another vendor's I/O software rather than the Agilent IO Libraries Suite, your I/O software may not support remote interface addressing.

If you are not using remote interfaces, you will address your instruments as TCPIP resources in VISA. These addresses include the IP address or hostname of the E5810B as well as the SICL address of the device on the E5810B.

Use these addresses in your `viOpen()` call as follows. These examples assume that the VISA interface ID of your TCPIP interface is `TCPIP0`. (You can specify this interface ID with the Connection Expert utility; `TCPIP0` is the default VISA ID for the default TCPIP interface.)

```
viOpen  
(... "TCPIP0::my_IP_address::gpib0,22::INSTR"...)
viOpen  
(... "TCPIP0::my_IP_address::usb0::INSTR"...)
viOpen  
(... "TCPIP0::my_IP_address::COM1,488::INSTR"...)
```

## Addressing instruments with SICL

SICL addresses include the IP address or hostname of your E5810B as well as the SICL address of the device on the E5810B, and optionally the protocol to be used. Some example addresses for SICL programs are as follows. These examples assume that the SICL interface ID of your TCPIP interface is `lan`. (You can specify this interface ID with the Connection Expert utility. The default SICL ID for TCPIP0 interface is `lan`.)

```
lan[my_IP_Address]:gpib0,22
lan;vxi-11[my_IP_Address]:gpib0,22
lan[my_IP_Address]:usb0
lan;vxi-11[my_IP_Address]:usb0
lan[my_IP_Address]:COM1,488
lan;sicl-lan[my_IP_Address]:gpib0,11
```

### NOTE

At the time of writing, National Instruments I/O software does not support the SICL-LAN protocol, but only the VXI-11 protocol. As the RS-232 instruments are only supported by SICL-LAN and not VXI-11, you are not able to use National Instruments I/O software to program an RS-232 instrument on your E5810B.



## 3 E5810B Web Access

Web Browser	44
Welcome Page	45
Navigation bar	46
E5810B current settings	47
E5810B support information banner	49
Viewing and Modifying the E5810B Configuration	50
Viewing the E5810B configuration	50
Modifying the E5810B configuration	51
Finding and Querying Instruments	61
Finding instruments	62
Querying instruments	64
Other Web Access Functions	67
Determining the session status	67
Web access help	68
Updating the E5810B firmware	69

This chapter describes the guidelines on how to use the E5810B Web access and configure the E5810B.



## Web Browser

You can access and communicate with the E5810B using a Web browser as the E5810B is Web-enabled. To communicate with the E5810B, Microsoft Internet Explorer 6 or greater is required (Internet Explorer 7 or greater is recommended for Windows Vista, Windows 7, Windows 8, Windows Server 2008 R2, and Windows Server 2012).

To display the E5810B Welcome page, go to your Web browser and type `http://<hostname>` or `http://<IP address>` at the address line.

<code>&lt;hostname&gt;</code>	The hostname (if known) of the E5810B.
<code>&lt;IP address&gt;</code>	The current E5810B IP address (for example 169.254.58.10) shown on the E5810B front panel display.

# Welcome Page

The screenshot shows the E5810B LAN/GPIB/USB Gateway web interface. At the top right, there is a navigation bar with links for 'Support | Products | Agilent Site' and a note: 'Another web-enabled product from Agilent Technologies'. The main header includes the Agilent Technologies logo and the text 'E5810B LAN/GPIB/USB Gateway'. A left-hand navigation bar contains icons for 'Welcome Page', 'View & Modify Configuration', 'Find & Query Instruments', 'Session Status', 'Print Page', and 'Help with this Page'. The main content area displays a welcome message and a table of current settings. A photograph of the E5810B device is shown on the right with the text 'Supporting your I/O needs'. Below the settings table is a section for 'E5810B Documentation' with links to 'Help' and 'User's Guide'. Numbered callouts 1 through 4 point to the navigation bar, settings table, documentation links, and the top right navigation bar respectively.

Agilent Technologies E5810B LAN/GPIB/USB Gateway

Support | Products | Agilent Site

Another web-enabled product from Agilent Technologies

Welcome to your  
**Web-Enabled E5810B LAN/GPIB/USB Gateway**

Use the Navigation Bar on the left to access your E5810B

Your Current Settings are:

Ethernet (MAC) Address:	44:E8:A5:00:01:21
Hostname:	Not Known
IP Address:	141.183.191.227
GPIB SICL Interface Name:	gpib0
USB SICL Interface Name:	usb0
RS-232 SICL Interface Name:	COM1
Firmware Revision:	E5810B_20121106_R001_STAND
Serial Number:	MY50360021

E5810B Documentation:

- [Help](#)
- [User's Guide](#)

Supporting your I/O needs

Figure 3-1 E5810B Welcome page

- 1 Navigation bar
- 2 E5810B current settings
- 3 E5810B documentation
- 4 E5810B support information

## Navigation bar

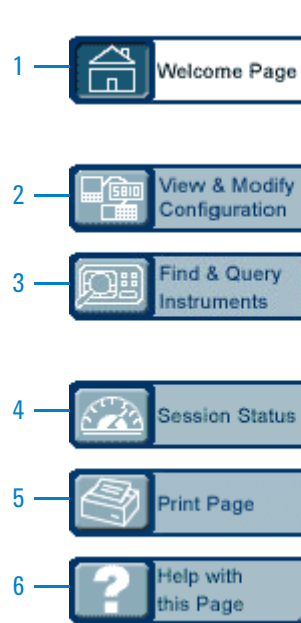

**Figure 3-2** Navigation bar

1

#### **Welcome Page**

Displays the E5810B Welcome page.

2

#### **View & Modify Configuration**

Displays the Current Configuration of E5810B LAN/GPIB/USB Gateway page. You can view and modify the current configuration parameters from this page.

3

#### **Find & Query Instruments**

Displays the Find and Control Instruments Connected to your E5810B page. You will be prompted to enter the E5810B password prior to viewing this page. You can interact with the connected GPIB, USB, or RS-232 instruments from this page.



4

**Session Status**

Displays the E5810B LAN/GPIB/USB Gateway Status page. You can view the current Firmware Revision, LAN Speed at Reboot, Time since Reboot, and Connection Status from this page.

5

**Print Page**

Prints the currently displayed page on the default printer.

6

**Help with this Page**

Displays the Web help page for the currently displayed page.

## E5810B current settings

Your Current Settings are:

1	<b>Ethernet (MAC) Address:</b>	44:E8:A5:00:01:21
2	<b>Hostname:</b>	<i>Not Known</i>
3	<b>IP Address:</b>	141.183.191.227
4	<b>GPIB SICL Interface Name:</b>	gpib0
5	<b>USB SICL Interface Name:</b>	usb0
6	<b>RS-232 SICL Interface Name:</b>	COM1
7	<b>Firmware Revision:</b>	E5810B_20121106_R001_STAND
8	<b>Serial Number:</b>	MY50360021



Support

**Figure 3-3** E5810B current settings

1

**Ethernet (MAC) Address**

The Ethernet (MAC) address is the unique address assigned by the manufacturer for each Internet device. The Ethernet (MAC) address is printed on a label at the bottom panel of the E5810B.

2

**Hostname**

The hostname is the Internet domain name for the E5810B that may be used to communicate with the E5810B. This is not a required configuration value.

### 3 E5810B Web Access

Welcome Page

#### 3 IP Address

An IP address is a 32-bit numeric address expressed as four numbers separated by periods (for example, 152.160.10.240).

#### 4 GPIB SICL Interface Name

Each GPIB interface used by Agilent VISA or SICL must have an SICL Interface Name. For VXI-11 protocol, use `gpi0`.

#### 5 USB SICL Interface Name

The default value for the USB SICL interface name is `usb0`.

#### 6 RS-232 SICL Interface Name

The default value for the RS-232 SICL interface name is `COM1`. Client SICL applications will use the full SICL name of `COM1, 488`.

#### 7 Firmware Revision

The current firmware revision on this E5810B. Refer to “Updating the E5810B firmware” on page 69 for information on updating the E5810B firmware.

#### 8 Serial Number

The E5810B unique serial number is printed on a label at the bottom panel of the E5810B.

## E5810B documentation links

### E5810B Documentation:

1 — [Help](#)

2 — [User's Guide](#)

Figure 3-4 E5810B documentation links

#### 1 Help

Accesses the E5810B Web Access Help. The help contains the guidelines for the E5810B Web access.

#### 2 User's Guide

Displays the E5810B User's Guide. Adobe Reader is required to view the E5810B User's Guide.

## E5810B support information banner

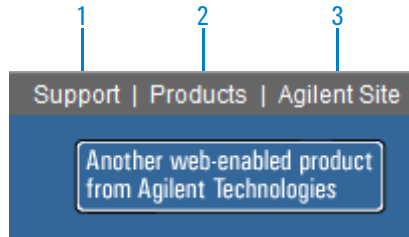

**Figure 3-5** E5810B support information banner

1

### **Support**

Connects you to the Agilent Contact Us Web page. You can find information about selecting and purchasing products, technical support, equipment service and repair, and training from this Web page.

2

### **Products**

Connects you to the E5810B product Web page. You can find the product and service information for the E5810B from this Web page.

3

### **Agilent Site**

Connects you to the Agilent Web page. You can access information about Agilent from this Web page.

## Viewing and Modifying the E5810B Configuration

### Viewing the E5810B configuration

Select the **View & Modify Configuration** tab from the navigation bar on the Welcome page to display the Current Configuration of E5810B LAN/GPIB/USB Gateway page as shown in [Figure 3-6](#).

The screenshot shows the web interface for the E5810B LAN/GPIB/USB Gateway. The page title is "Current Configuration of E5810B LAN/GPIB/USB Gateway". A "Modify Configuration" button is visible above the configuration table. The table lists various parameters and their current values.

Parameter	Currently in use
DHCP:	ON
IP Address:	141.183.191.227
Subnet Mask:	255.255.252.0
Default Gateway:	141.183.188.1
DNS Server(s):	141.183.230.30, 141.183.236.41
Hostname:	<i>Not Known</i>
Description:	
Universal Plug and Play:	ON
LAN Keepalive (sec):	7200
I/O Timeout (sec):	120
GPIB SICL Interface Name:	gpib0
GPIB Address:	21
GPIB Logical Unit:	7
USB SICL Interface Name:	usb0
RS-232 SICL Interface Name:	COM1
RS-232 SICL Logical Unit:	1

**Figure 3-6** Current Configuration of E5810B LAN/GPIB/USB Gateway page

## Modifying the E5810B configuration

Select **Modify Configuration** from the Current Configuration of E5810B LAN/GPIB/USB Gateway page to modify the E5810B configuration as shown in [Figure 3-6](#). You will be prompted to enter the E5810B password. The default password is E5810. The Configuring your E5810B LAN/GPIB/USB Gateway page is displayed as shown in [Figure 3-7](#).

Support | Products | Agilent Site

Agilent Technologies E5810B LAN/GPIB/USB Gateway

Another web-enabled product from Agilent Technologies

### Configuring your E5810B LAN/GPIB/USB Gateway

Note: You must click both "Save" and then "Reboot E5810" before changes to parameters become effective.

Undo Edits Save Reboot E5810 Factory Defaults

Parameter	Configured Value	Edit Configuration
DHCP:	ON	<input type="radio"/> OFF <input checked="" type="radio"/> ON
These LAN parameters will be used during boot if DHCP is OFF or unavailable		
IP Address:	169.254.58.10	<input type="text" value="169.254.58.10"/>
Subnet Mask:	255.255.0.0	<input type="text" value="255.255.0.0"/>
Default Gateway:	0.0.0.0	<input type="text" value="0.0.0.0"/>
DNS Server:	0.0.0.0	<input type="text" value="0.0.0.0"/>
Hostname:		<input type="text"/>
Description:		<input type="text"/>
Universal Plug and Play:	ON	<input type="radio"/> OFF <input checked="" type="radio"/> ON
LAN Keepalive (sec):	7200	<input type="text" value="7200"/>
I/O Timeout (sec):	120	<input type="text" value="120"/>
GPIB SICL Interface Name:	gpib0	<input type="text" value="gpib0"/>
GPIB Address:	21	<input type="text" value="21"/>
GPIB Logical Unit:	7	<input type="text" value="7"/>

**Figure 3-7** Configuring your E5810B LAN/GPIB/USB Gateway page

You can configure the E5810B settings to your desired parameters by typing or selecting the new value in the **Edit Configuration** column. Select **Save** and **Reboot E5810B** at the top or the bottom of the page to save the settings.

### 3 E5810B Web Access

#### Viewing and Modifying the E5810B Configuration

#### NOTE

- Most changes to the configuration parameters are not effective until you select **Save** and **Reboot E5810B**.
- To reset the configuration to the factory default settings, press the **Preset** button on the E5810B front panel for more than 10 seconds.

**Table 3-1** E5810B configuration parameters description

Parameter	Default setting	Description
Dynamic Host Configuration Protocol (DHCP)	ON	<p>DHCP is a protocol for assigning dynamic IP addresses to devices on a network. DHCP supports a mix of static and dynamic IP addresses.</p> <p><i>DHCP ON (Default):</i> If the DHCP is turned on, the E5810B will try to obtain an IP address from a DHCP server. If this fails, the E5810B will use its static IP address. If the DHCP is turned on and a DHCP server is found, the manually configured IP address, subnet mask, and default gateway parameters are not used by the E5810B during startup.</p> <p><i>DHCP OFF:</i> If the DHCP is turned off or unavailable, the E5810B will use the static IP address that may be inputted in the Configuring your E5810B LAN/GPIB/USB Gateway page during startup. In this case, the values for the IP address, subnet mask, and default gateway shown in the <b>Configured Value</b> column of the page will be used during startup.</p>

**Table 3-1** E5810B configuration parameters description (continued)

Parameter	Default setting	Description
IP Address	169.254.58.10	<p>The Internet Protocol (IP) address of the E5810B is a required value and is used for all IP and TCP/IP communications with the E5810B. The IP address is represented in dotted decimal notation (for example, 154.140.222.201). This number is assigned by the system administrator.</p> <p>LAN traffic to the E5810B will be routed by the IP address or by using a hostname that may be provided by a DNS name server which is mapped to this IP address. The current E5810B IP address may have been established in one of these two methods:</p> <ul style="list-style-type: none"> <li>• The IP address was provided by a DHCP server during startup (dynamic IP address).</li> <li>• The IP address shown on the Current Configuration of the E5810B LAN/GPIB/USB Gateway page was used. This was set by default to 169.254.58.10. If DHCP is not used, the IP address should be set for your network.</li> </ul>
Subnet Mask	255.255.0.0	<p>Subnet mask is used to enable the E5810B and determine if a client's IP address is on the same local subnet as the E5810B. When a client's IP address is on a different subnet, all packets must be sent to a subnet gateway.</p> <p>Refer to <a href="#">"Glossary"</a> for an example of a subnet.</p>
Default Gateway	0.0.0.0	<p>The default gateway is the IP address of the default subnet gateway that allows the E5810B to communicate with systems that are not on the local subnet. This is the default subnet gateway where packets are sent to a device not on the local subnet, as determined by the subnet mask setting. Only one default subnet gateway can be configured. A value of 0.0.0.0 indicates that no subnetting is configured.</p>

### 3 E5810B Web Access

#### Viewing and Modifying the E5810B Configuration

**Table 3-1** E5810B configuration parameters description (continued)

Parameter	Default setting	Description
Domain Name Server (DNS)	0.0.0.0	<p>A DNS server is an Internet service that translates domain names into IP addresses. Every time you use a domain name, a DNS server will translate the name into the corresponding IP address. For example, the domain name www.example.com might be translated to 198.105.232.4.</p> <p>The DNS system has its own network. If one DNS server does not know how to translate a particular domain name, it will ask another DNS server. For example, a DNS server will ask until the correct IP address is returned, if it is available.</p> <p>If DHCP is used, a DHCP server may provide a DNS server IP address to the E5810B (this is transparent to the user). If you configure a DNS server, the E5810B will try to use that server first.</p> <p>This parameter shows the IP address of the domain name server. More than one address may be listed on the Current Configuration of the E5810B LAN/GPIB/USB Gateway page. Up to two of these values may have been returned by the DHCP server during startup. Only one static value can be inputted on the Configuring your E5810B LAN/GPIB/USB Gateway page.</p> <p>The DNS server provides a hostname, given that the IP address for a LAN device is based on entries in its DNS lookup table. If DHCP is turned off, and you do not specify a DNS server or if a dynamic DNS is not available on your enterprise LAN, and your IP address is not in the DNS lookup table on the DNS server, your hostname will be unknown and you must address the E5810B only by the IP address. The hostname is not a required configuration value.</p>



**Table 3-1** E5810B configuration parameters description (continued)

Parameter	Default setting	Description
Hostname	None	<p>The hostname configures the Internet domain name for the E5810B. Hostnames are useful when IP addresses are being assigned by a DHCP server, since the hostname will not change when the DHCP server or the device IP address changes.</p> <p>If a hostname is entered, the E5810B will try to register this name when it boots up. The E5810B can only register the hostname if the network has a dynamic DNS. If the network does not have dynamic DNS, this value is not used. Because you can always use the IP address or the name (possibly supplied by another name server), the hostname is not a required configuration value.</p> <p>You may enter up to 35 characters for the hostname. The hostname must start with a letter, and it consists of upper and lower case letters, digits, and dashes. There is no default hostname. If a hostname is displayed on the Welcome page, it is a valid hostname as one was found on the network through the DNS.</p>
Description	Factory-set	<p>The default description consists of E5810B followed by the Ethernet (MAC) address. The Ethernet (MAC) address is printed on a label at the bottom panel of the E5810B.</p> <p>A typical description is Agilent E5810B 00-30-D3-05-00-23, where 00-30-D3-05-00-23 is the Ethernet (MAC) address. The description is the UPnP Friendly Name of the E5810B that will automatically be displayed on Universal Plug and Play (UPnP) enabled LAN hosts.</p> <p>When the E5810B is connected to the LAN, it broadcasts its presence to the network if UPnP is enabled. UPnP clients will see the E5810B in My Network Places, listed by this description. A Friendly Name can be up to 39 characters, including spaces.</p>

### 3 E5810B Web Access

#### Viewing and Modifying the E5810B Configuration

**Table 3-1** E5810B configuration parameters description (continued)

Parameter	Default setting	Description
Universal Plug & Play [UPnP]	ON	<p>If Universal Plug &amp; Play (UPnP) is enabled, a multicast message is generated and sent about once an hour to the subnet. Enterprise networks will want to decide whether this additional traffic is acceptable. By default, UPnP is not enabled. Check your operating system instructions to enable UPnP.</p> <ul style="list-style-type: none"><li>• <i>UPnP ON:</i> The E5810B is configured as a UPnP device and provides information to the network about itself via an XML description when mounted to the network.</li><li>• <i>UPnP OFF:</i> The E5810B is not UPnP capable and will not announce its presence as a UPnP device when mounted to the network.</li></ul>
LAN Keepalive	7200 seconds	<p>The LAN keepalive value sets the LAN connection timeout in seconds. The E5810B may use the TCP keepalive timer of the TCP/IP protocol stack to determine if a client is still reachable. By specifying this configuration value, the E5810B turns on the keepalive timer when connecting to the client.</p> <p>After a specified time, if there is no activity on the connection, the E5810B sends keepalive probes to the client to determine if it is still alive. After the specified amount of time, the connection will be marked as down or dropped, and the E5810B will release any resources that were allocated to the associated client.</p> <p>A value of 0 means no timeout is set. The E5810B will wait forever and no keepalive probes are sent. If this value is set, it is recommended that the largest value be used which will still meet the application's need for unreachable client detection.</p> <p>Smaller LAN keepalive values will generate more keepalive probes (network traffic), using more of the available network bandwidth. Allowable values are 0 and greater than or equal to 600 seconds (10 minutes).</p>

**Table 3-1** E5810B configuration parameters description (continued)

Parameter	Default setting	Description
I/O Timeout	120 seconds	<p>The I/O timeout value sets the server I/O timeout in seconds. It configures the E5810B to use an I/O timeout of the specified amount of seconds if a client requests a timeout of infinity. If 0 is specified for this value and the client requests an infinite timeout, the E5810B will use a timeout of infinity as requested.</p> <p>Setting the I/O timeout to 0 is not recommended, as this can result in the E5810B waiting indefinitely for an I/O operation and effectively stall the E5810B.</p> <p>This timeout value may be used to ensure that the E5810B does not wait indefinitely for an I/O operation. It also allows the E5810B to detect certain network events that may go undetected, such as when a client's connection is dropped. If the E5810B detects this condition, it will release any resources, such as locks which are associated with the client.</p>
GPIB SICL Interface Name	gpob0	<p>The GPIB SICL interface name is the symbolic name of the GPIB interface in the E5810B. It is used in an SICL client application's iopen operation to symbolically reference the GPIB interface in the E5810B.</p> <p>The maximum length of the GPIB interface name is 15 characters. If VXI-11 (TCP/IP Instrument Protocol) is used, the name must be <code>gpib&lt;n&gt;</code>. The names <code>hpib</code> or <code>hpib7</code> may be used to support legacy programs, if only SICL/LAN protocols are used.</p>
GPIB Address	21	<p>The GPIB address is the GPIB bus address of the E5810B. This address is used when transfers are made on the GPIB bus.</p> <p>An SICL client application can change this value by using the SICL function <code>IGPIBBUSADDR</code>. The GPIB address value can be any number from 0 to 30.</p>
GPIB Logical Unit	7	<p>The GPIB logical unit is the interface logical unit (LU) number of the GPIB interface in the E5810B. It may be used in an Agilent SICL client application's iopen statement to uniquely identify the GPIB interface in the E5810B.</p> <p>The GPIB logical unit value can be any number from 1 to 255.</p>

### 3 E5810B Web Access

#### Viewing and Modifying the E5810B Configuration

**Table 3-1** E5810B configuration parameters description (continued)

Parameter	Default setting	Description
USB SICL Interface Name	usb0	<p>The USB SICL interface name is the symbolic name of the USB interface in the E5810B. It is used in an Agilent SICL iopen operation to symbolically reference the USB interface in the E5810B. It is also used in the Remote USB Interface dialog (as Interface name on remote Host) when specifying a USB device for Agilent VISA.</p> <p>The USB interface used by Agilent VISA or SICL must have an SICL interface name. The maximum length of the USB SICL interface name is 15 characters.</p>
RS-232 SICL Interface Name	COM1	<p>The RS-232 SICL interface name is the symbolic name of the RS-232 interface in the E5810B. It is used in an Agilent SICL iopen operation to symbolically reference the RS-232 interface in the E5810B. It is also used in the Remote RS-232 Serial Interface dialog (as Interface name on remote Host) when specifying an RS-232 device for Agilent VISA.</p> <p>The RS-232 interface used by Agilent VISA or SICL must have an SICL interface name. The maximum length of the RS-232 SICL interface name is 15 characters.</p>
RS-232 Baud Rate	9600	<p>The RS-232 baud rate is the number of bits per second that are transmitted. The available RS-232 baud rates for the E5810B are 300, 1200, 2400, 4800, 9600, 19200, 38400, 57600, and 115200.</p> <p>The RS-232 baud rate is the speed of the data transmission and reception on the RS-232 interface. The baud rate value is dependent on the peripheral device you connect to the RS-232 port. Check the documentation for your peripheral device to set this value.</p>
RS-232 Parity	NONE	<p>The RS-232 parity is used by the RS-232 hardware to verify data transmission. The available RS-232 parity for the E5810B are NONE, ODD, EVEN, SPACE, and MARK.</p> <p>The parity value is dependent on the peripheral device you connect to the RS-232 port. Check the documentation for your peripheral device to set this value.</p>

**Table 3-1** E5810B configuration parameters description (continued)

Parameter	Default setting	Description
RS-232 Bits	8	<p>The RS-232 bits are the number of bits that comprise a byte of data. The available number of RS-232 bits for the E5810B are 5, 6, 7, or 8.</p> <p>This is the number of data bits in a character frame in the RS-232 serial data transmission. The value is dependent on the peripheral device you connect to the RS-232 port. Check the documentation for your peripheral device to set this value.</p>
RS-232 Stop Bits	1	<p>The RS-232 stop bit is a bit that indicates that a byte has just been transmitted. Every byte of data is preceded by a start bit and followed by a stop bit. The available RS-232 stop bits are 1 or 2. Stop bits is the number of bits used to indicate the end of a character frame in RS-232 serial data transmission.</p> <p>The stop bits value is dependent on the peripheral device you connect to the RS-232 port. Check the documentation for your peripheral device to set this value.</p>
RS-232 Flow Control	NONE	<p>The RS-232 flow control is the protocol used to pace data transmission over the RS-232 serial connection. The available RS-232 flow control mechanisms for the E5810B are NONE, XON/XOFF, RTS/CTS, and DTR/DSR.</p> <p>The flow control value is dependent on the peripheral device you connect to the RS-232 port. Check the documentation for your peripheral device to set this value.</p>
RS-232 SRQ	RI	<p>The RS-232 SRQ is the method used to request service from the RS-232 device. The SRQ line is the modem status line on the RS-232 interface that is monitored for Service ReQuests (SRQs). The available SRQ options for the E5810B are RI, DCD, DSR, and CTS.</p>
E5810B Serial Number	Factory-set	<p>The E5810B serial number is the individual serial number assigned at the factory for each E5810B. The serial number is printed on a label at the bottom panel of the E5810B and has the form of MY12345678.</p>

### 3 E5810B Web Access

#### Viewing and Modifying the E5810B Configuration

**Table 3-1** E5810B configuration parameters description (continued)

Parameter	Default setting	Description
Ethernet (MAC) Address	Factory-set	<p>The Ethernet Media Access Control (MAC) address is also known as the link-level address, the Ethernet (station) address, the LANIC ID, and hardware address. This is a unique 48-bit address assigned by the manufacturer for each Ethernet device.</p> <p>The Ethernet (MAC) address is usually in 12 hexadecimal characters, with colon or dash separators between every two characters, such as 00 : 30 : D3 : 05 : 00 : 23 or 00-30-D3-05-00-23. The Ethernet (MAC) address is printed on a label at the bottom panel of the E5810B.</p>
Password	E5810	<p>E5810B configuration and instrument control pages are password-protected against changes. To change from the default password (or any password) to a new one, enter the current (old) password in the <b>Configured Value</b> column and enter the new password in both boxes in the <b>Edit Configuration</b> column of the Configuring your E5810B LAN/GPIB/USB Gateway page.</p> <p>You do not need to use a password for SICL or VISA programs with the E5810B interface. This administrative password is not for security purposes and will not prevent unauthorized personnel from using the E5810B. The password will only prevent inadvertent changes to the E5810B interface settings or control of instruments attached to the E5810B. It is not intended to provide a strong level of security for either the interface or the attached network.</p>

## Finding and Querying Instruments

Select the **Find & Query Instruments** tab from the navigation bar on the Welcome page to display the Find and Control Instruments Connected to your E5810B page as shown in [Figure 3-8](#).

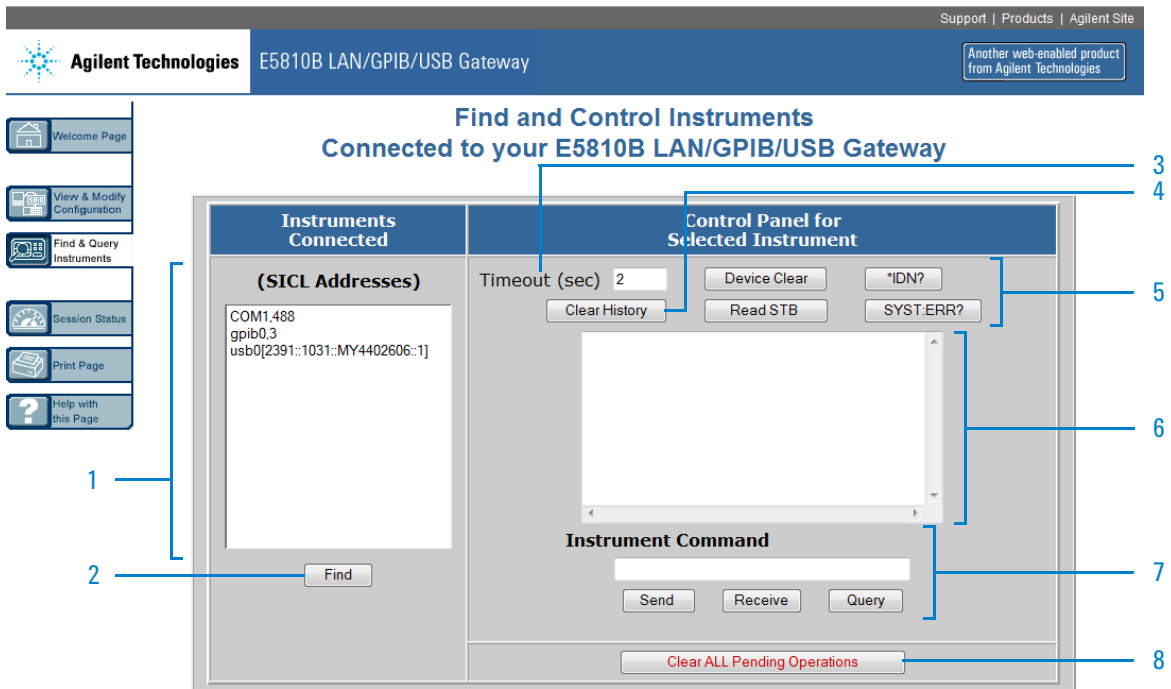

**Figure 3-8** Find and Control Instruments Connected to your E5810B

- 1 Displays the list of instruments connected to the E5810B. The selected connected instrument will be highlighted.
- 2 Select **Find** to display the connected instruments. The first time this page is opened, no instruments are displayed.
- 3 Sets the instrument timeout value in seconds.

### 3 E5810B Web Access

#### Finding and Querying Instruments

- 4 Clears the display of all previous queries
- 5 Select **Device Clear**, **\*IDN?**, **Read STB**, or **SYST:ERR?** to query the selected instrument.
- 6 Displays the queries results.
- 7 Enter a command on the Instrument Command line and then select **Send**, **Receive**, or **Query** (sends and receives).
- 8 Clears all pending operations and expire all existing timeouts on instruments connected to the E5810B.

## Finding instruments

The Instruments Connected column displays the SICL address for each GPIB, USB, or RS-232 instrument connected to your E5810B. The SICL address is required for the E5810B to interact with the instruments programmatically.

To refresh the display or if instruments have been added or deleted, select **Find** to display the current configuration. The **Find** command is automatically performed when the Find and Control Instruments Connected to your E5810B page is opened and the correct password is provided. However, if no instruments are displayed when the first time this page is opened, select **Find** to display the current list of instruments that are powered up and connected to the E5810B.

After selecting **Find**, all connected instruments should appear in the Instruments Connected column. The top item, **COM1,488** will always be listed whether or not you have an RS-232 instrument connected. All other devices shown in the Instruments Connected column are the SICL addresses of your connected instruments. If no connected instruments are found, a message to this effect is displayed in the output text area.



### Checking for connected instruments

If you do not see one or more of your connected instruments in the list, try these steps:

**1** *Check the cables.*

Make sure that all the instruments are connected via GPIB cable, USB cable, or RS-232 cable to the E5810B GPIB port, USB port, or RS-232 port respectively.

**2** Turn on the instrument and select **Find** at the bottom of the Instruments Connected column.

**3** *Check Hardware.*

A broken instrument may short out the cable and cause the instrument to show a failure. For GPIB instruments, if you are experiencing problems, try connecting only one GPIB instrument to the E5810B at a time. Possible causes of the problem may be broken cable, loose connectors, two or more instruments at the same GPIB address, an instrument may be broken, or the E5810B may be broken.

**4** *Reboot the E5810B.*

After checking the hardware connections, reboot the E5810B to do a self-test for the E5810B hardware.

## Querying instruments

After you have successfully found all the connected instruments, you can use the Control Panel for Selected Instrument section of the page to interact with the instruments. There are two ways to interact with the connected instruments – using the buttons at the top of the column or using the Instrument Command line at the bottom of the column.

### NOTE

To program instruments using VISA, VISA COM, SICL, or Agilent VEE, you must install and configure the Agilent IO Libraries Suite on your PC (refer to [Chapter 2](#), “Installing the E5810B”).

For VISA programming information, refer to the Agilent VISA User’s Guide. If the Agilent IO Libraries Suite is installed, you can access an electronic version of the manual by selecting the IO icon on the taskbar and selecting **Documentation > VISA User’s Guide**. The same Documentation menu also includes the VISA COM and SICL information.

---

After highlighting the instrument to be addressed in the Instruments Connected column, you can select the predefined query button – **Device Clear**, **\*IDN?**, **Read STB**, or **SYS:ERR?** to communicate with the instrument.

### NOTE

The query buttons will only work if the selected instrument supports IEEE 488.2 and SCPI command sets.

---

You can also clear the display on the screen by selecting **Clear History**, set the timeout value (in seconds) by typing in the desired value in the Timeout (sec) dialog box, or clear all pending operations on the instruments connected to the E5810B by selecting **Clear ALL Pending Operations**. [Table 3-2](#) lists the description for all the buttons and the Timeout (sec) dialog box.

**Table 3-2** Buttons description

Button	Description
Device Clear	Sometimes communication with an instrument may be impeded. This can occur for a wide variety of reasons. Sending a <code>Device Clear</code> command to the instrument usually solves this problem and restores proper communication with the instrument. If you encounter an error while performing a formatted I/O operation, send a <code>Device Clear</code> command to ensure a proper instrument communication is restored.
*IDN? (ID string)	Returns the ID string for the selected IEEE-488.2 compliant instrument.
Read STB (Read Status Byte)	Returns the decimal and hexadecimal value of the IEEE-488.2 compliant instrument's status byte. Many instruments that support formatted I/O also have the ability to read the status byte. This command returns the information on the status of the instrument, such as error status and busy status. See your instrument manuals for the status byte codes.
SYST:ERR? (System error)	Returns a SCPI system error for a SCPI compliant instrument. A return, <b>0 No errors</b> is sent to show no system errors.
Clear History	Clears the display of all previous queries.
Clear ALL Pending Operations	Clears all pending operations on instruments connected to the E5810B. This operation expires all existing timeouts on all the devices connected to the E5810B. Taking this action may affect other users currently using the E5810B. A password dialog box will appear that prompts you to confirm this action.
Timeout	<p>A timeout value is used to limit the amount of time for an I/O operation to complete. The I/O timeout value, as set on the <i>Configuring your E5810B LAN/GPIB/USB Gateway</i> page, may not be long enough for some instrument activities to complete. Setting a longer timeout will inform the E5810B to wait a longer time for the instrument to finish.</p> <p>Alternatively, sending a separate <code>Send</code> and <code>Receive</code> command may also work. If the configuration value is too long, you may also force a shorter timeout here for faster troubleshooting of the instrument tests. To set a different timeout, enter a timeout value in the <b>Timeout</b> text box. This value is used for all commands issued to an instrument from this page. The valid timeout range is 1 to 60 seconds.</p>

#### Using the instrument command line

For supported instruments, you can also query an instrument by first highlighting the instrument in the Instruments Connected column, type in a SCPI command, such as `meas:volt:dc?` on the Instrument Command line, and then select **Send**, **Receive**, or **Query**.

To send a command to the instrument without waiting for a response, select **Send**. Sending a string to the instrument does not return a result.

To receive a string from the instrument, select **Receive**. To perform sending the string and receiving a response from the instrument, select **Query**.

#### NOTE

The display buffers up to 200 lines of information. At 200 lines, the last lines are overwritten with new information. At this point, you may want to select the **Clear History** button.

---

## Other Web Access Functions

### Determining the session status

Select the **Session Status** tab from the navigation bar on the Welcome page to determine the E5810B session status. The E5810B LAN/GPIB/USB Gateway Status page is shown in [Figure 3-9](#). Select **Refresh** to update display to the current E5810B configuration.

#### E5810B LAN/GPIB/USB Gateway Status

<b>Firmware Revision:</b>	B.00.42
<b>LAN Speed at Reboot:</b>	1000 Mbps
<b>Time since Reboot:</b>	121:46:42 hh:mm:ss
<b>Connection Status</b>	
Client IP Addr    Session ID    Operation    Lock    Device/Intf	

**Figure 3-9** E5810B LAN/GPIB/USB Gateway Status page

1

#### Firmware Revision

Displays the current E5810B firmware revision. Refer to [“Updating the E5810B firmware”](#) on page 69 for the steps to update the E5810B to the latest firmware version.

2

#### LAN Speed at Reboot

Displays the LAN speed at the time the E5810B is last rebooted.

### 3 E5810B Web Access

Other Web Access Functions

#### 3 Time since Reboot

Displays the time since the last reboot of the E5810B.

#### 4 Connection Status

Displays the current status of all open sessions for the E5810B, including the Client IP Address, Session Number, Device/ Instrument Operation (READ), Lock Status, and Device/Interface name.

When a device is locked, the device name (such as DEV) appears in the Lock column. In this case, the device cannot be used by anyone other than the user who set the lock.

## Web access help

Select **Help** at the E5810B Documentation section in the E5810B Welcome page to display the E5810B Web Access Help. The Web Access Help table of contents page is shown in [Figure 3-10](#).

### NOTE

The Windows toolbar appears at the top of the display for ease of navigation, and printing. You can also access a topic either from the navigation pane on the left side or on table of contents page.

Select **Hide** to hide the navigation pane. If the navigation pane is not shown, select **Show** to display the navigation pane.

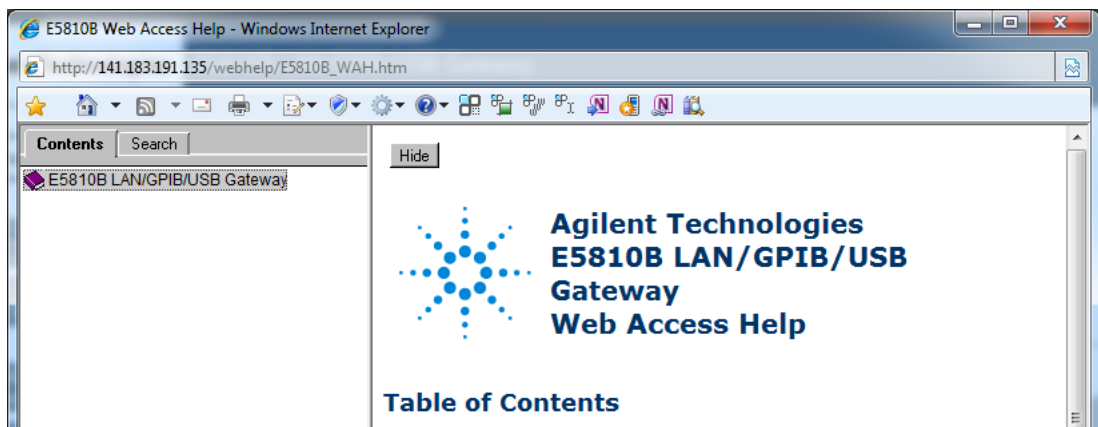

**Figure 3-10** E5810B Web Access Help

## Updating the E5810B firmware

### NOTE

Do not update your E5810B firmware unless you have a specific need to do so, such as defect repair or instrument enhancements. If the firmware update fails, the E5810B will revert to its original firmware version.

The E5810B uses a standard File Transfer Protocol (FTP) or via a connected USB drive to perform updates.

The E5810B acts as an FTP client and searches for an FTP server that contains the E5810B firmware image. Agilent maintains a publicly accessible FTP server that contains the latest E5810B firmware at:

<ftp.agilent.com>

**Login:** anonymous

**Password:** <your email address>

The latest E5810B firmware is located at [/pub/e5810/e5810b/e5810\\_B\\_latest\\_firmware.hex](/pub/e5810/e5810b/e5810_B_latest_firmware.hex). Prior versions are also available in this FTP directory.

If you cannot access the Agilent FTP server from your E5810B, you can use any standard FTP server that is available, provided you have an image of the firmware. The requirements are an FTP server, an image of the E5810B firmware, and a LAN connection between the E5810B and the FTP server.

The procedure to update the E5810B firmware depends on whether or not the Agilent FTP site is accessible from the E5810B or how your network is configured. The E5810B FTP client used to upload new firmware is a standard FTP client and currently does not support proxies. This means that anyone behind a firewall will most likely not be able to directly access the Agilent FTP site.

## Updating the E5810B firmware via a connected USB drive

### 1 *Acquire an image of the E5810B firmware.*

Obtain the image from your Web browser. You may need to set up an FTP proxy on your Web browser.

- i On your Web browser, type  
<ftp://ftp.agilent.com/pub/e5810/e5810b/> to connect you to the Agilent FTP server or type  
<http://www.home.agilent.com/agilent/software.jspx?ckey=2426653&lc=eng&cc=MY&nid=-34195.1051168&id=2426653> to display the E5810B LAN/GPIB/USB Gateway Firmware Web page. This page displays the files associated with the E5810B.
- ii Select the file **e5810\_B\_latest\_firmware.hex** or click the download button respectively and save it to the USB drive. For example, in the Internet Explorer, right-click the file and select **Copy to Folder**. Other Web browsers may have a different sequence.

#### NOTE

- Alternatively, you can directly FTP to the Agilent FTP server at [ftp.agilent.com](ftp://ftp.agilent.com) using the anonymous FTP, supplying the user login, and downloading the file at [/pub/e5810/e5810b/e5810\\_B\\_latest\\_firmware.hex](/pub/e5810/e5810b/e5810_B_latest_firmware.hex).
- The E5810B supports the USB drive formatted in the FAT32 or XFAT32 format only.

### 2 *Verify that the E5810B is idle.*

Updating the E5810B is a significant activity. Ensure that no other users or programs are using the E5810B before you attempt to update the firmware. You can check the number of open sessions by displaying the E5810B LAN/GPIB/USB Gateway Status page. To open this page, select the **Session Status** tab on the Navigation Bar. It is recommended that you reboot the E5810B before performing the firmware update process.



- 3 *Open the Updating Firmware page.*
  - i Select **Updating the E5810B Firmware** in the E5810B Web Access Help Table of Contents to display the Updating your Firmware page.
  - ii Select the **Update the E5810B firmware** hyperlink on this page. You will be prompted for a password before the Update Firmware on your E5810B LAN/GPIB/USB Gateway dialog box is displayed as shown in Figure 3-11.

## Update Firmware on your E5810B LAN/GPIB/USB Gateway

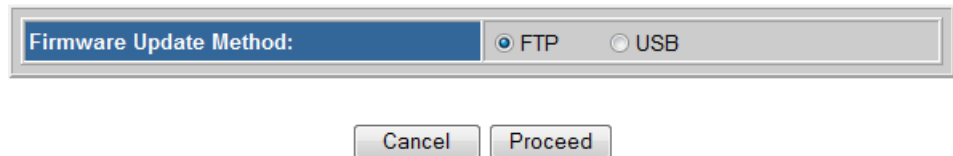

**Figure 3-11** E5810B LAN/GPIB/USB Gateway dialog box

- iii Select **USB** as the firmware update method and select **Proceed**.

### NOTE

You can also directly access the Updating Firmware page on your E5810B LAN/GPIB/USB Gateway page at [http://<IP\\_Address>/dynamicWebFile/firmware\\_update\\_login.php](http://<IP_Address>/dynamicWebFile/firmware_update_login.php), where <IP\_Address> is the IP address displayed on the front display panel of the E5810B.

4 *Perform firmware update.*

- i You will be prompted with an update firmware (via USB) message dialog box as shown in [Figure 3-12](#).

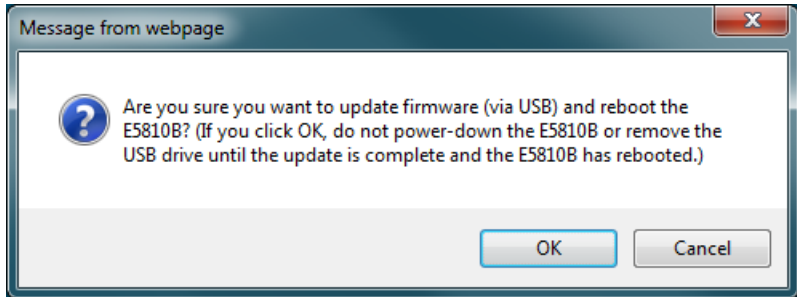

**Figure 3-12** Update firmware (via USB) message dialog box

- ii Ensure that the USB drive with the firmware image file is connected and select **OK**.
- iii After you have confirmed the update, the E5810B front panel should display the **Updating firmware...** message.
- iv The USB LED should flash, indicating USB activity is taking place.
- v If the USB drive is not connected or there is no firmware image file found, you will be prompted by an error message dialog box as shown in [Figure 3-13](#). Select **OK** and repeat [step 3](#).

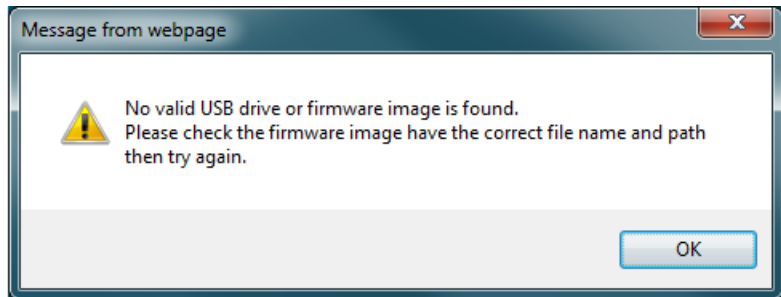

**Figure 3-13** Error message dialog box

- vi After the firmware image has been downloaded into the E5810B, the E5810B will automatically reboot and display the **Rebooting E5810B...** message. The E5810B will then begin a normal startup sequence.
- 5 *Verify the firmware revision.*

When the E5810B is successfully rebooted, verify that the firmware has been downloaded successfully by displaying the E5810B Welcome page and verify that the firmware revision number shows the correct version of the firmware.

### **Agilent FTP site is accessible from the E5810B**

- 1 *Verify that the E5810B is idle.*

Updating the E5810B is a significant activity. Ensure that no other users or programs are using the E5810B before you attempt to update the firmware. You can check the number of open sessions by displaying the E5810B LAN/GPIB/USB Gateway Status page. To open this page, select the **Session Status** tab on the Navigation Bar. It is recommended that you reboot the E5810B before performing the firmware update process.

- 2 *Open the Updating Firmware page.*

- i Select **Updating the E5810B Firmware** in the E5810B Web Access Help Table of Contents to display the Updating your Firmware page.
- ii Select the **Update the E5810B firmware** hyperlink on this page. You will be prompted for a password before the Update Firmware on your E5810B LAN/GPIB/USB Gateway dialog box is displayed as shown in [Figure 3-14](#).

## Update Firmware on your E5810B LAN/GPIB/USB Gateway

The dialog box has a title bar and a main area with a label 'Firmware Update Method:' on the left. To the right of the label are two radio buttons: 'FTP' (which is selected) and 'USB'. Below the main area are two buttons: 'Cancel' and 'Proceed'.

**Figure 3-14** E5810B LAN/GPIB/USB Gateway dialog box

- iii Select **FTP** as the firmware update method and select **Proceed** to display the page as shown in [Figure 3-15](#).

## Update Firmware on your E5810B LAN/GPIB/USB Gateway

The dialog box contains four rows of input fields, each with a label on the left and a text input on the right. The labels are: 'Firmware FTP Server Hostname or IP Address:', 'User Login:', 'Password:', and 'Firmware File:'. The corresponding values are: 'ftp.agilent.com', 'anonymous', '.....', and '/pub/e5810/e5810b/e5810\_B\_latest\_firmware.h'. Below the input fields are two buttons: 'Cancel' and 'Update Firmware'.

**Figure 3-15** E5810B LAN/GPIB/USB Gateway dialog box (FTP)

**NOTE**

You can also directly access the Updating Firmware page on your E5810B LAN/GPIB/USB Gateway page at [http://<IP\\_Address>/dynamicWebFile/firmware\\_update\\_login.php](http://<IP_Address>/dynamicWebFile/firmware_update_login.php), where <IP\_Address> is the IP address displayed on the front panel display of the E5810B.

**3** *Check that all the default parameters are correct.*

- **Firmware FTP server Hostname or IP Address:** [ftp.agilent.com](http://ftp.agilent.com)
- **User Login:** Enter the login name for the FTP server.
- **Password:** Enter the password associated with the login name.
- **Firmware File:**  
[/pub/e5810/e5810b/e5810\\_B\\_latest\\_firmware.hex](http://pub/e5810/e5810b/e5810_B_latest_firmware.hex)

**4** *Perform firmware update.*

- Select **Update Firmware** to display the password dialog box. Select **OK** to confirm the update and the E5810B will attempt to download the firmware from the FTP site.
- After you have confirmed the update, the E5810B front panel should display the **Updating firmware...** message.
- The LAN LED should flash, indicating LAN activity is taking place. The firmware for the E5810B is approximately 12 MB and downloading time may vary, depending on network connections.
- After the firmware image has been downloaded into the E5810B, the E5810B will automatically reboot and display the **Rebooting E5810B...** message. The E5810B will then begin a normal startup sequence.

**5** *Verify the firmware revision.*

When the E5810B is successfully rebooted, verify that the firmware has been downloaded successfully by displaying the E5810B Welcome page and verify that the firmware revision number shows the correct version of the firmware.

### **Agilent FTP site is not accessible from the E5810B**

**1** *Acquire an image of the E5810B firmware.*

If the Agilent FTP site is not accessible from the E5810B, you may still be able to get the image from your Web browser. You may need to set up an FTP proxy on your Web browser.

- i On your Web browser, type <ftp://ftp.agilent.com/pub/e5810/e5810b/> to connect you to the Agilent FTP server. This page displays the files associated with the E5810B.
- ii Select the file **e5810\_B\_latest\_firmware.hex** and save it. For example, in the Internet Explorer, right-click the file and select **Copy to Folder**. Other Web browsers may have a different sequence.

**NOTE**

Alternatively, you can directly FTP to the Agilent FTP server at [ftp.agilent.com](ftp://ftp.agilent.com) using the anonymous FTP, supplying the user login, and downloading the file at [/pub/e5810/e5810b/e5810\\_B\\_latest\\_firmware.hex](ftp://ftp.agilent.com/pub/e5810/e5810b/e5810_B_latest_firmware.hex).

**2** *Install FTP server program, if needed.*

You will need to access a standard FTP server program. Refer to “[Troubleshooting guidelines](#)” on page 80 for tips to access a standard FTP server.

**3** *Set up the user account information for the FTP server.*

Refer to the FTP server documentation on creating a user account and a password. The user account is used for the login name.

**4** *Copy the E5810B firmware image to the FTP directory.*

Once you have an FTP login, copy the E5810B firmware image to the directory on the FTP server's file system that is associated with the user account as set up in [step 3](#). Manually start the FTP server, if needed.

5 *Verify that the E5810B is idle.*

Updating the E5810B is a significant activity. Ensure that no other users or programs are using the E5810B before you attempt to update the firmware. You can check the number of open sessions by displaying the E5810B LAN/GPIB/USB Gateway Status page. To open this page, select the **Session Status** tab on the Navigation Bar. It is recommended that you reboot the E5810B before performing the firmware update process.

6 *Open the Updating Firmware page.*

- i Select **Updating the E5810B Firmware** in the E5810B Web Access Help Table of Contents to display the Updating your Firmware page.
- ii Select the **Update the E5810B firmware** hyperlink on this page. You will be prompted for a password before the Update Firmware on your E5810B LAN/GPIB/USB Gateway dialog box is displayed as shown in [Figure 3-16](#).

## Update Firmware on your E5810B LAN/GPIB/USB Gateway

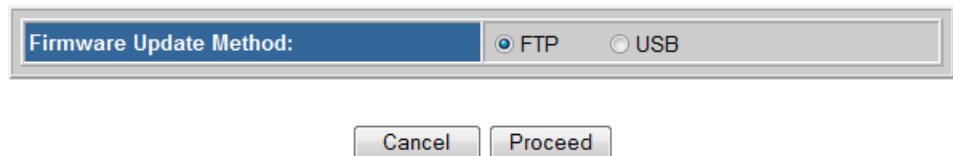

**Figure 3-16** E5810B LAN/GPIB/USB Gateway dialog box

- iii Select **FTP** as the firmware update method and select **Proceed** to display the page as shown in [Figure 3-17](#).

## Update Firmware on your E5810B LAN/GPIB/USB Gateway

Firmware FTP Server Hostname or IP Address:	ftp.agilent.com
User Login:	anonymous
Password:	•••••
Firmware File:	/pub/e5810/e5810b/e5810_B_latest_firmware.h

**Figure 3-17** E5810B LAN/GPIB/USB Gateway dialog box (FTP)

### NOTE

You can also directly access the Updating Firmware page on your E5810B LAN/GPIB/USB Gateway page at [http://<IP\\_Address>/dynamicWebFile/firmware\\_update\\_login.php](http://<IP_Address>/dynamicWebFile/firmware_update_login.php), where <IP\_Address> is the IP address displayed on the front display panel of the E5810B.

### 7 *Configure the FTP parameters and filename:*

- **Firmware FTP server Hostname or IP Address:** Enter the IP address of the FTP server (for example, 192.6.143.21) or enter the FTP server domain name, if a DNS server is available and configured in the E5810B (for example, ftp.agilent.com).
- **User Login:** Enter the login name for the FTP server.
- **Password:** Enter the password associated with the login name.



- **Firmware File:** Enter the filename of the E5810B firmware. The default filename is e5810\_B\_latest\_firmware.hex. You may also need to add the appropriate directory information to locate the file on the FTP server.

#### 8 *Perform firmware update.*

- i Select **Update Firmware** to display the password dialog box. Select **OK** to confirm the update and the E5810B will attempt to download the firmware from the FTP site.
- ii After you have confirmed the update, the E5810B front panel should display the **Updating firmware...** message.
- iii The LAN LED should flash, indicating LAN activity is taking place. The firmware for the E5810B is approximately 12 MB and downloading time may vary, depending on network connections.
- iv After the firmware image has been downloaded into the E5810B, the E5810B will automatically reboot and display the **Rebooting E5810B...** message. The E5810B will then begin a normal startup sequence.

#### 9 *Verify the firmware revision.*

When the E5810B is successfully rebooted, verify that the firmware has been downloaded successfully by displaying the E5810B Welcome page and verify that the firmware revision number shows the correct version of the firmware.

## Troubleshooting guidelines

The E5810B records information on the firmware update process in a system log that is viewable through the E5810B Web access or through the E5810B Telnet interface.

### 1 *View the system log from the E5810B Web access.*

To view the system log information on the E5810B Web access, on your Web browser address line, type:  
`http://<IP Address>/systemLog.htm` where  
<IP Address> is the IP address displayed on the E5810B front panel display and select **Enter** to display the system log. After a successful firmware update, the E5810B systems log should show normal startup messages as shown below.

**(00:00:00.00) Selftest Passed**

**(00:00:00.00) Searching for DHCP Server**

**(00:00:00.00) GPIB initialized with name : [gpib0]**

**(00:00:00.00) RS232 initialized with name : [COM1]**

**(00:00:00.00) USB initialized with name : [usb0]**

### 2 *View the system log from Telnet.*

To view the system log from Telnet, click **Start** and select **Run...**, or right-click the bottom-left corner of the Desktop and select **Run** (Windows 8). Type `telnet <IP_Address>` on the Run dialog box line, where <IP\_Address> is the IP address displayed on the E5810B front panel display.

Refer to [Appendix A](#), “Using the Telnet Utility” for more information on the Telnet utility. When the Telnet client is launched, you can view the system log by typing `syslog-display`. After a successful firmware update, the E5810B systems log should show normal startup messages as shown below.

**(00:00:00.00) Selftest Passed**

**(00:00:00.00) Searching for DHCP Server**

**(00:00:00.00) GPIB initialized with name : [gpib0]**

**(00:00:00.00) RS232 initialized with name : [COM1]**

**(00:00:00.00) USB initialized with name : [usb0]**

**3** *If the update is unsuccessful.*

If the last message in the system log indicates the E5810B was trying to update firmware, the firmware process was not successful and the E5810B will display a message dialog. In this case, try the following:

**i** *Verify the FTP server address.*

Verify that the firmware FTP server domain name is correct and fully qualified. A domain name is a symbolic name for an IP address. For example, **ftp.agilent.com** is the domain name for IP Address 192.6.143.21. Try to manually use the FTP to access the FTP server that contains the E5810B firmware. Verify that the firmware file is in the proper directory and that the firmware file has the correct name.

**ii** *Manually enter the DNS server address.*

For the firmware update process to use a domain name, the E5810B must have a DNS setup. If you statically configured the IP address for the E5810B, you will need to manually enter the DNS server address in the Configuring your E5810B LAN/GPIB/USB Gateway page.

**iii** *Use the IP address.*

Try using the IP address of the FTP server instead of the domain name.

**4** *Check login, password, and firmware name entries.*

Ensure that the login, password, and firmware filename are entered correctly and that the login name and password match a valid user account on the FTP server.

**iv** *Check directory information.*

Ensure that the correct directory information is present (if needed), such as [/pub/e5810/e5810b/e5810\\_B\\_latest\\_firmware.hex](#). If you use the directory information, make sure that the directory designator character is correct for your FTP server. Some FTP servers use / (forward slash) and others use \ (backslash).

**3 E5810B Web Access**  
Other Web Access Functions

**THIS PAGE HAS BEEN INTENTIONALLY LEFT BLANK.**



## 4 Troubleshooting the E5810B

Overview	84
Checking the E5810B	86
Checking the E5810B front panel display	86
Checking the E5810B parameters	88
Checking the Network	89
Checking the Web browser settings	90
Checking other network problems	92
Checking PC Client Connection	94
Verifying PC client connection	94
Checking the Syslog messages	95
Runtime error messages	98
Checking Connected Instruments	101

This chapter provides the guidelines to troubleshoot problems that may occur with the E5810B.



# Overview

**NOTE**

There are no user-serviceable parts in the E5810B. If you suspect a hardware failure in the E5810B, contact Agilent for procedures to return the device.

Figure 4-1 shows a typical network configuration using the E5810B and the suggested steps to troubleshoot the system.

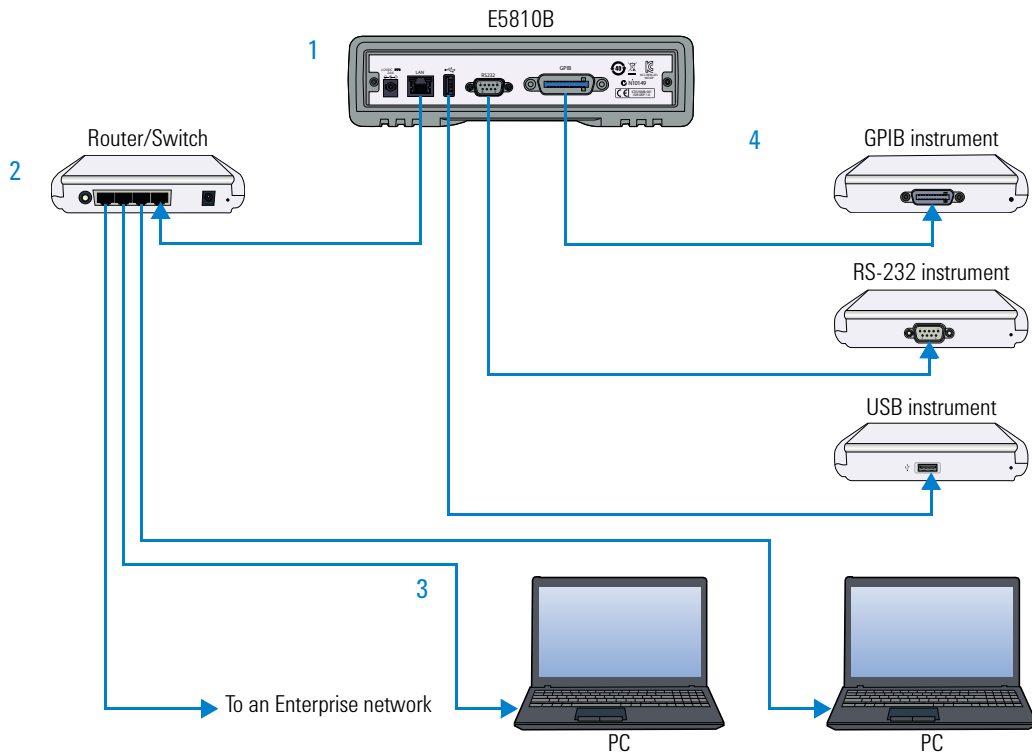

**Figure 4-1** Troubleshooting overview

**1****Checking the E5810B**

- Checking the E5810B front panel display
- Checking the E5810B LED indicators
- Checking the E5810B parameters

**2****Checking the Network**

- Checking the Web browser settings
- Checking other network problems

**3****Checking PC Client Connection**

- Verifying PC client connection
- Checking the Syslog messages
- Runtime error messages

**4****Checking Connected Instruments**

# Checking the E5810B

## Checking the E5810B front panel display

Table 4-1 shows the suggested steps to troubleshoot the E5810B using the front panel display.

**Table 4-1** E5810B front panel display

Error message	Description
Firmware update not successful	The firmware update failed. Verify that the IP address of the FTP server, login, user password, and filename are correct.
ERROR:NV RAM Setting defaults	Configurations in the nonvolatile data memory are corrupted. All data were restored to the factory default settings, per the nonvolatile RAM (Random Access Memory).
ERROR: Selftest See Syslog	A power-on self-test error occurred. Errors may be viewed in the Syslog message by typing <code>http://&lt;IP Address&gt;/systemLog.htm</code> .
ERROR: No LAN connection found	LAN link integrity is not detected. Make sure that the LAN cable is connected and the LAN connection is active.
ERROR: IP in use <addr>	<p>The E5810B tried to use an IP address that is currently being used by another device on the network.</p> <p>Try one of these actions:</p> <ul style="list-style-type: none"><li>• Press the Preset button and reboot the E5810B to set the E5810B back to booting with DHCP enabled.</li><li>• Remove other device(s) from the network and reboot the E5810B.</li><li>• Move the E5810B to a local network, disable DHCP, and set the E5810B to an unused IP Address.</li></ul>



## Checking the E5810B LED indicators

Table 4-2 shows the suggested steps to troubleshoot the E5810B using the LED indicators. If there is an error message on the front panel display, refer to “Checking the E5810B front panel display” on page 86.

**Table 4-2** E5810B LED indicators

Status	Possible cause	Corrective action
All LEDs OFF	No AC power to the E5810B.	Check the AC power connection.
Power – ON FAULT – ON	If the FAULT LED indicator is turned ON for more than 10 seconds, there may be hardware failure.	Contact Agilent for instructions to return the E5810B.
Power – ON LAN (back panel) – OFF	No communication from the PC to the E5810B using LAN.	Check the E5810B LAN connection.
Power – ON LAN – ON (flashes) GPIB, USB, and/or RS-232 – OFF (during instrument activity)	There is communication from the PC to the E5810B using LAN. However, there is no communication to the GPIB, USB, or RS-232 instruments.	Check the GPIB, USB, or RS-232 connection and configuration.

**NOTE**

The FAULT LED indicator turns on at power-on while the E5810B is running a self-test. If the LED turns ON for more than 10 seconds and there is no IP address displayed on the front panel display, the E5810B may be experiencing hardware failure.

## Checking the E5810B parameters

If the front panel display and LED indicators are in no error conditions, check the E5810B configuration parameters.

### Check the current E5810B parameters

If the E5810B is connected to an Enterprise network, you can check the E5810B current settings displayed on the Configuring your E5810B LAN/GPIB/USB Gateway page against the Enterprise Network Information provided by your system administrator. If the settings do not match, reconfigure the E5810B from the Configuring your E5810B LAN/GPIB/USB Gateway page.

#### NOTE

If the E5810B is connected to an Enterprise network, ensure that you contact your system administrator before making any configuration changes to the E5810B. If E5810B configuration checks are required, refer to [Chapter 3](#), “Viewing and Modifying the E5810B Configuration” for more information.

### Reset the E5810B

#### NOTE

Terminate all applications with the E5810B before performing this.

You can use the **Preset** button on the E5810B front panel to reset the E5810B to its default settings. There are two modes of operation.

- **Press the Preset button <10 seconds**

The E5810B password is temporarily set to the default value, E5810. The E5810B configuration parameters remain the same. The password will remain until the E5810B is rebooted.

- **Press the Preset button >10 seconds**

The E5810B configuration parameters are set to the factory default settings and the E5810B is rebooted.

## Checking the Network

If the E5810B is correctly installed and configured, and is operational, the next step is to check on the network installation and configuration. You may need the help of your system administrator to perform this.

**Table 4-3** Network configuration problems summary

Symptom	Possible cause	Corrective action
Cannot access E5810B Web access	Improper network installation.	Check the network installation or contact your system administrator.
	Missing or improper setup of network addresses: <ul style="list-style-type: none"> <li>• Ethernet (MAC) address</li> <li>• IP address</li> <li>• Subnet mask</li> <li>• Default gateway (router)</li> </ul>	Try the ping command ( <code>ping &lt;IP_address&gt;</code> on the MS-DOS window). If this does not work, contact your system administrator.
	Incorrect Web browser settings.	Enable Javascript and configure the Cache and Page Refresh, and Proxies settings on your Web browser. Refer to <a href="#">“Checking the Web browser settings”</a> on page 90.
Incorrect password	Unknown or forgotten password.	Press the <b>Preset</b> button >10 seconds to reset the E5810B to the factory default settings.
Other network problems	<ul style="list-style-type: none"> <li>• E5810B operation hangs.</li> <li>• SICL timeout is set to 0.</li> </ul>	Refer to <a href="#">“Checking other network problems”</a> on page 92.

## Checking the Web browser settings

The E5810B Web access generates Web pages that depend on Javascript and Frames. For best results, you will need to enable the Javascript, and configure the Cache and Page Refresh, and Proxies settings on your Web browser.

### Enable Javascript (Internet Explorer 6 or greater)

If the E5810B detects that Javascript is not enabled, a dialog box will pop-up on the E5810B Welcome page displaying the instructions to enable Javascript on the Web browser.

If Javascript is not enabled, you will not be able to view the View and Modify Configurations page or the Find and Query Instruments page.

Use the following procedure to enable Javascript.

- 1 Select **Tools > Internet Options** from the Internet Explorer menu.
- 2 Select the **Security** tab.
- 3 Select **Custom level...** under Security level for this zone to display the Security Settings dialog box.
- 4 Under Settings, scroll down to the Scripting category.
- 5 Select the **Enable** check box under Active Scripting.
- 6 Select the **Enable** check box under Scripting of Java applets.
- 7 Select **OK** to accept the security settings.
- 8 Follow the instructions as prompted to save the settings.

### Cache and Page Refresh (Internet Explorer 6 or greater)

Typically, Web browsers cache Web pages to store an image of the Web page locally. When you navigate to an already viewed page, the page is loaded from the cache rather than from the network. This is acceptable for static Web pages in which the information does not change.

However, the E5810B uses dynamic Web pages in which the information are dynamically updated.

To avoid displaying outdated information on the Web pages, set the **Check for newer versions of stored pages** to **Every visit to the page** or a similar option on your Web browser.

Use the following procedure to configure the Cache and Page Refresh settings.

- 1 Select **Tools > Internet Options** from the Internet Explorer menu.
- 2 Select the **General** tab.
- 3 Select **Settings** under Browsing history to display the Settings dialog box.
- 4 Select the **Every time I visit the webpage** check box under Check for newer versions of stored pages:.
- 5 Select **OK** to accept the settings change.

### **Proxies (Internet Explorer 6 or greater)**

If you are using a proxy server, the Web page may time-out even though the correct IP address or hostname is entered into the Web browser.

To avoid this, the Web browser must be informed that any requests to the E5810B should not use a proxy. Add the IP address of the E5810B to the list box at **Do not use proxy server for addresses beginning with:** or a similar option on your Web browser.

Use the following procedure to set the proxy notification.

- 1 Select **Tools > Internet Options** from the Internet Explorer menu.
- 2 Select the **Connections** tab.
- 3 Select **LAN Settings** under Local Area Network (LAN) settings.
- 4 Select **Use a proxy server for your LAN** check box if it is not checked under Proxy server and select **Advanced**.

- 5 Under **Exceptions**, add the IP address of the E5810B or a fully qualified domain name (such as `myE5810B.example.com`) to the **Do not use proxy server for addresses beginning with:** box. Use a semicolon ';' to separate the entries.
- 6 Select **OK** to save the settings.

## Checking other network problems

### E5810B operation hangs

The E5810B has a single remote IO server servicing the GPIB, USB, and RS-232 interfaces. If one of the interface hangs in an operation where a timeout has been set to a long time period, there is no more communication on the interface until the pending transaction completes (via normal completion, or a timeout). That is, a pending operation on the RS-232 interface will stall the GPIB or USB operations, and vice-versa.

To avoid this, set a short timeout for the GPIB, USB, and RS-232 interfaces, so that the E5810B is not left in a hung situation awaiting a pending I/O operation. For example, a detached or loose GPIB, USB, or RS-232 cable can cause an operation to stall if timeouts are set too high.

Setting long timeouts with the E5810B is not recommended. However, if a long timeout period is required for your programming application, you can set the timeout with these commands:

```
VISA: viSetAttribute() and VI_ATTR_TMO_VALUE  
attribute
```

```
SICL: itimeout()
```

Refer to the *Agilent VISA User's Guide* and the *Agilent SICL User's Guide* for a description of the VISA command and SICL command respectively.

### SICL timeout is set to 0 (infinite)

The E5810B uses the LAN maximum timeout configured in Agilent Connection Expert's LAN interface for its default or infinite timeout. If an SICL `itimeout(id,0)` command is used (where a 0 timeout value is an infinite timeout) the E5810B will use the I/O Timeout (sec): value set on the Current Configuration of E5810B LAN/GPIB/USB Gateway page.

The default timeout value is 120 seconds. Setting the I/O Timeout (sec): value to 0 enables infinite timeouts from SICL applications.

#### NOTE

It is highly not recommended to set an infinite timeout which can cause the E5810B to become unresponsive due to a pending operation that will never timeout.

Setting long timeouts with the E5810B is not recommended. However, if a long timeout period is required for your application, you can set the timeout with these commands:

VISA: `viSetAttribute(vi, attr, attrState)` where:  
`attr` is `VI_ATTR_TMO_VALUE` `attrState` is a large value

SICL: `itimeout(id,tval)`, where `tval` is a large number

## Checking PC Client Connection

### Verifying PC client connection

To verify that the PC client system has network access to the E5810B, open the Web browser on the client's PC and type in the E5810B IP address or hostname (if known) on the browser's address line. If the E5810B Welcome page appears, this client's PC has network connection to the E5810B. Repeat this step for each client's PC on the network.

#### NOTE

You can also use the Telnet utility or a ping command from a DOS command window to check for network connections to the E5810B. Refer to [Appendix A](#), "Using the Telnet Utility" for more information.

If the Welcome page time-out, this indicates that the client's PC was not able to connect to the E5810B. The E5810B may be on a different subnet than the client or the E5810B may have incorrect network configuration values. In this case, try the ping command. If the ping command does not work, contact your system administrator.

### Using the ping command

To send a ping command from your PC to the E5810B, open the MS-DOS program window. When the MS-DOS window is launched, type `ping <IP_address>`, where `<IP_address>` is the IP address of the E5810B, and press **Enter**.



## Checking the Syslog messages

The Syslog messages can be viewed by typing <E5810B IP address>/systemLog.htm on your Web browser, where <E5810B IP address> is the IP address of the E5810B. For example, if the IP address of the E5810B is 169.254.58.10, type `http://169.254.58.10/systemLog.htm` to display the message table.

The Syslog file messages can also be viewed via the Telnet Syslog-display command (refer to [Appendix A](#), “Using the Telnet Utility”). A typical display (with time from power-on in parentheses) is shown in [Figure 4-2](#).

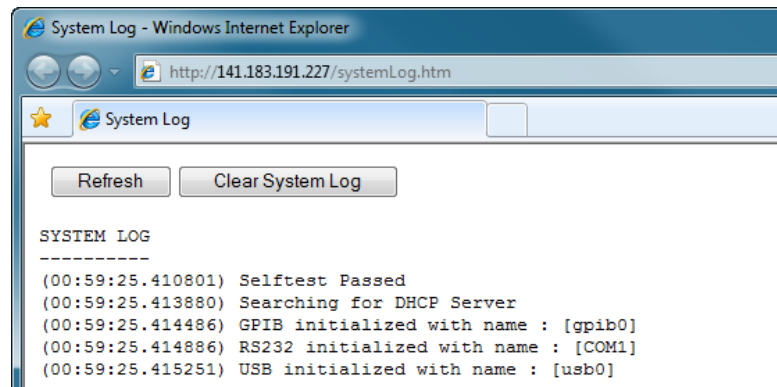

**Figure 4-2** Typical Syslog display

## Syslog messages

Table 4-4 shows the common Syslog messages generated by the E5810B.

**Table 4-4** Common Syslog messages

Message	Description
Selftest Passed	E5810B has successfully completed its hardware self-test.
rebooting	E5810B is about to do a reboot or a factory-reset command.
Max connections exceeded, client IP_address refused	A client specified by the IP_address was not allowed to connect to the E5810B because the maximum number of concurrent client connections on the E5810B has been exceeded. No more than 16 client connections can be running concurrently on the E5810B and fewer may be allowed, depending on memory usage for existing clients.
client: <id> <id> Opened client: <id> <id> Closed	Typical open or close messages (logged each time a client opens or closes a connection).  client: 156.140.104.184, id: 1 opened
Firmware update: Looking for FTP server	Logged prior to trying to do a 'ls' command on the FTP server to see if any data may be fetched.
Firmware update: Beginning firmware update	Logged prior to starting to get the file.
Firmware update complete	Firmware update was successful. This message is usually not seen, as the E5810B reboots after download is complete.
ERROR: Firmware update already in progress, cannot begin update	Tried to begin an update while an update is already in progress.
ERROR: Firmware Update: No DNS server, cannot use hostname	A hostname was used for the FTP server, but there is no DNS server configured. Configure a DNS server or use an IP address for the FTP server.
ERROR: Firmware Update: Hostname not found	Could not find hostname. Hostname or DNS server may be invalid.
ERROR: Firmware Update: FTP server not found	Could not find FTP server specified.
ERROR: Firmware Update: Invalid User Login or Password	Login or password is invalid for the FTP server.
ERROR: Firmware Update: Data not received from FTP server	Could not receive data from the FTP server. May be trying to access FTP server through a firewall.

**Table 4-4** Common Syslog messages (continued)

Message	Description
ERROR: Firmware Update: Invalid file or directory	Could not find file. Filename or directory is wrong.
ERROR: Firmware Update: Internal error	Out of system resources. Reboot the E5810B and try again.

Table 4-5 shows the typical Syslog messages and provides a description of each message, where the value is in ( ), such as (0:00:00:18). The value is the time since power-on expressed in Day (DD):Hour (HH):Minutes (MM):Seconds (SS).

**Table 4-5** Typical Syslog messages

Message	Description
(0:00:00:00) Selftest Passed	Power-on self-test results.
(00:00:00.00) GPIB initialized with name : [gpib0] (00:00:00.00) RS232 initialized with name : [COM1] (00:00:00.00) USB initialized with name : [usb0]	GPIB, RS-232, and USB initialized.
(0:00:00:18) client: 156.140.104.184, id: 1 opened (0:00:00:18) client: 156.140.104.184, id: 1 closed (0:00:00:18) client: 156.140.104.184, id: 1 opened (0:00:00:19) client: 156.140.104.184, id: 2 opened (0:00:00:19) client: 156.140.104.184, id: 3 opened	Typical open or close messages (logged each time a client opens or closes a connection).
(0:00:39:21) Max connections exceeded, client refused	Indicates the server had the maximum number of connections when another connection was requested, so the request was refused.

## Runtime error messages

Common runtime errors that may occur in programs when using the E5810B are described in the [Table 4-6](#), where `viopen` is a VISA open command.

**Table 4-6** Common runtime messages

Message	Description
viopen fails: Invalid address errors	Use the E5810B Welcome page on your Web browser to verify that the GPIB address, GPIB interface name, and GPIB logical unit configuration values are correct, or you can use Agilent Connection Expert. To open Agilent Connection Expert, select the IO icon on the Windows taskbar notification area and then select <b>Agilent Connection Expert</b> .
viopen fails: No connection	The connection to the E5810B failed for one of these reasons: <ul style="list-style-type: none"><li>• A TCP/IP network timeout occurred because the network connection is down or the E5810B is down.</li><li>• The E5810B has reached its maximum concurrent client connections (16) and this new connection was refused. You may need to have a client close its connection or you may need to reboot the E5810B to close all client connections to allow a new connection to be made. Up to 16 sessions can be in use at any one time.</li></ul>
viopen fails: Timeout	The client has timed out. The E5810B has not responded within the appropriate timeout time because: <ul style="list-style-type: none"><li>• The network connection is down or the E5810B is down.</li><li>• The server is busy performing an operation for a different client. You may need to increase the client delta timeout configuration value on the LAN client's PC. To set this value, select the IO icon on the Windows taskbar notification area and then select <b>Agilent Connection Expert</b>.</li></ul> <p>In the Agilent Connection Expert window, select the LAN interface that is associated with your remote GPIB and/or remote serial interface. Select <b>Change Properties...</b> in the detail pane on the right. When the LAN Interface properties dialog box appears, set the desired client delta timeout value and then select <b>OK</b>.</p>

**Table 4-6** Common runtime messages (continued)

<b>Message</b>	<b>Description</b>
viopen fails or I/O operation fails: Out of resources	The E5810B was not able to open another session or perform the operation because it is out of resources. You may need to have a client terminate its connection or you may need to reboot the E5810B to close all client connections to reclaim resources. Rebooting will disconnect all other users accessing the E5810B.
I/O operation fails: No connection	The connection to the E5810B failed because: <ul style="list-style-type: none"> <li>• The network connection is down or the E5810B is down and network timeout occurred.</li> <li>• The E5810B was powered-off and then powered-on, or the E5810B reboot was executed, either of which terminates any open client connections.</li> </ul>
I/O operation fails: Timeout	There are several possible causes: <ul style="list-style-type: none"> <li>• The client may be attempting a transaction to a non-existent or powered-off device. Check the address used, as well as the status of the device.</li> <li>• The network connection or the E5810B has gone down since the previous I/O operation.</li> <li>• The I/O timeout specified is not long enough for the transaction to complete. You may need to verify that the E5810B I/O timeout configuration value is long enough if the client specified a timeout value of infinity.</li> <li>• The E5810B is busy performing an I/O operation for another client or another client has the device/interface locked. Refer to <a href="#">“E5810B appears to be hung”</a> for more information.</li> </ul>

**Table 4-6** Common runtime messages (continued)

Message	Description
E5810B appears to be hung	<p>There are several possible causes. For all of the following, use of client timeouts and/or E5810B timeouts (the I/O timeout and LAN timeout configuration values) can be used to ensure that the E5810B will not stall indefinitely.</p> <ul style="list-style-type: none"><li>• If you determine that the E5810B is truly hung, you may be able to free it by terminating a particular client connection at the client, thus freeing the resources to allow the E5810B to proceed. Otherwise, you can select the <b>Clear ALL Pending Operations</b> button on the Find and Control Instruments Connected to your E5810B Web page or you can reboot the E5810B.</li><li>• The network connection to the E5810B has been broken.</li><li>• The E5810B may be attempting a transaction to a non-existent or powered-off device. Check the address used, as well as the status of the device.</li><li>• The E5810B is busy performing a very long transaction to a (slow) device, or it is waiting for input from a device.</li><li>• A client may be waiting for access to a device/interface locked by another client. Check for possible deadlock situations and, if possible, make sure the clients owning locks and the connections to those clients are still up and functioning. You can check the current session by selecting the <b>Session Status</b> tab to display the E5810B LAN/GPIB/USB Gateway Status Web page.</li></ul>

## Checking Connected Instruments

If you cannot establish communication with the connected GPIB, USB, and/or RS-232 instruments, refer to [Table 4-7](#) for the suggested troubleshooting steps.

**Table 4-7** Checking GPIB, USB, and/or RS-232 interface instruments

Symptom	Possible cause	Corrective action
Unable to communicate from the E5810B Web access	Intermittent or missing GPIB, USB, and/or RS-232 connection.	Check the GPIB, USB, and/or RS-232 cable.
	GPIB, USB, and/or RS-232 device power is not turned on or a defective GPIB device.	Ensure that the GPIB, USB, and/or RS-232 device power is turned on and the device is operating properly.
	RS-232 interface is not configured for the attached device.	Change the E5810B RS-232 interface attributes to match the RS-232 device attributes (baud rate and parity).
Unable to communicate programmatically	VISA/SICL is not configured.	Run the Agilent Connection Expert utility (refer to <a href="#">Chapter 2</a> , "Installing the E5810B").
	Incorrect VISA/SICL address.	Check the VISA/SICL address being used.

**4 Troubleshooting the E5810B**  
Checking Connected Instruments

**THIS PAGE HAS BEEN INTENTIONALLY LEFT BLANK.**





## 5 Characteristics and Specifications

Technical Specifications	104
Supplementary Information	108
Supported Network Protocols	109

This chapter lists the characteristics and specifications of the E5810B LAN/GPIB/USB gateway.



# Technical Specifications

GENERAL CHARACTERISTICS	
<b>POWER CONSUMPTION</b>	<ul style="list-style-type: none"><li>• +12 VDC, 2 A</li><li>• Isolated ELV supply source</li></ul>
<b>OPERATING ENVIRONMENT</b>	Refer to “ <a href="#">Environmental Conditions</a> ” on page V.
<b>STORAGE COMPLIANCE</b>	Refer to “ <a href="#">Environmental Conditions</a> ” on page V.
<b>SAFETY AND EMC COMPLIANCE</b>	Refer to “ <a href="#">Environmental Conditions</a> ” on page V.
<b>CONNECTORS</b>	<ul style="list-style-type: none"><li>• Standard 24-pin IEEE488 (GPIB)</li><li>• USB 2.0</li><li>• 9-pin RS-232</li><li>• RJ-45 LAN</li></ul>
<b>MAXIMUM DATA RATES</b>	<ul style="list-style-type: none"><li>• 1.2 MB/s for GPIB</li><li>• 115 Kb/s for RS-232</li><li>• 480 Mb/s for USB</li></ul>
<b>LED INDICATORS</b>	<ul style="list-style-type: none"><li>• Power</li><li>• LAN</li><li>• GPIB</li><li>• USB</li><li>• RS-232</li><li>• FAULT</li></ul>
<b>DIMENSIONS (W × D × H)</b>	226.5 mm (8.92 in) × 238 mm (9.37 in) × 61mm (2.36 in)
<b>WEIGHT</b>	1.3 kg
<b>WARRANTY</b>	3 years

**GENERAL REQUIREMENTS**

**Minimum system requirements**

Windows XP SP3 (32-bit)

- 600 MHz (x86 or x64)
- 256 MB RAM
- Hard disk space
  - 1 GB available for Microsoft .NET Framework 4.0
  - 100 MB for Agilent IO Libraries Suite
- Video
  - 1024 × 768 (96 DPI or 120 DPI)
- Browser
  - Microsoft Internet Explorer 6 or greater

Windows Vista SP1 and SP2 (32-bit or 64-bit) Home Basic, Home Premium, Business, Ultimate, or Enterprise

- 1 GHz (x86 or x64),
- 1 GB RAM
- Hard disk space
  - 1 GB available for Microsoft .NET Framework 4.0
  - 100 MB for Agilent IO Libraries Suite
- Video
  - 1024 × 768 (96 DPI or 120 DPI)
- Browser
  - Microsoft Internet Explorer 7 or greater

Windows 7 SP1 (32-bit or 64-bit) Starter, Home Basic, Home Premium, Professional, Ultimate, or Enterprise

- 1 GHz (x86 or x64)
- 1 GB RAM
- Hard disk space
  - 1 GB available for Microsoft .NET Framework 4.0
  - 100 MB for Agilent IO Libraries Suite
- Video
  - 1024 × 768 (96 DPI or 120 DPI)
- Browser
  - Microsoft Internet Explorer 7 or greater

## 5 Characteristics and Specifications

### Technical Specifications

---

Windows 8 (32-bit or 64-bit) Windows 8, Windows 8 Pro, Windows 8 Enterprise

- 1 GHz (x86 or x64)
- 1 GB RAM
- Hard disk space
  - 1 GB available for Microsoft .NET Framework 4.0
  - 100 MB for Agilent IO Libraries Suite
- Video
  - 1024 × 768 (96 DPI or 120 DPI)
- Browser
  - Microsoft Internet Explorer 7 or greater

---

Windows Server 2008 R2 SP1 (64-bit) Standard and Enterprise

- 1.4 GHz (x64)
- 1 GB RAM
- Hard disk space
  - 1 GB available for Microsoft .NET Framework 4.0
  - 100 MB for Agilent IO Libraries Suite
- Video
  - 1024 × 768 (96 DPI or 120 DPI)
- Browser
  - Microsoft Internet Explorer 7 or greater

---

Windows Server 2012 (64-bit) Standard

- 1.4 GHz (x64)
- 1 GB RAM
- Hard disk space
  - 1 GB available for Microsoft .NET Framework 4.0
  - 100 MB for Agilent IO Libraries Suite
- Video
  - 1024 × 768 (96 DPI or 120 DPI)
- Browser
  - Microsoft Internet Explorer 7 or greater

---

#### Supported standards

Hardware

- LAN/Ethernet: 10BASE-T/100BASE-TX/1000BASE-T networks
- Standard 24-pin IEEE488 (GPIB)
- USB 2.0 or lower (with the USBTMC-USB488 protocol)
- RS-232

Software

- VXI-11 Protocol (GPIB only)
  - VISA 2.2 and Agilent SICL (GPIB, USB, and RS-232)
-

---

**Supported applications (with IntuiLink)**

- Microsoft Excel 2000 or greater
  - Microsoft Word 2000 or greater
- Check the Web for the latest supported applications.

---

**Supported software development applications**

- Visual Basic 5.0 or greater
- Visual C++ 5.0 or greater
- Visual Studio
- Agilent VEE 5.0 or greater
- BASIC for Windows
- Visual Studio .NET

---

**ORDERING INFORMATION**

**Interface**

E5810B LAN/GPIB/USB Gateway

**Options**

- Option 100 – Rack Mount Kit
  - 10833A – GPIB cable, 1 meter
  - 10833B – GPIB cable, 2 meter
  - 10833C – GPIB cable, 4 meter
  - 10833D – GPIB cable, 0.5 meter
  - 10833F – GPIB cable, 6 meter
  - 10833G – GPIB cable, 8 meter
  - 10834A – Adapter, extends GPIB connector 2.3 cm
-

## **Supplementary Information**

This section provides supplementary information on the E5810B performance, including supported GPIB modes.

### **GPIB modes of operation supported**

The E5810B supports all standard GPIB modes of operation.

### **IEEE-488.1 and IEEE-488.2 compliance**

The E5810B is in full compliance with the IEEE-488.1 and IEEE-488.2 specifications. The E5810B fully supports the IEEE-488.1 subsets – AH1, C1, C2, C3, C4, C27, DC0, DT0, LE3, PP0, RL0, SH1, SR0, and TE7.

### **Maximum number of simultaneous I/O connections**

The maximum number of simultaneous I/O connections supported by the E5810B is 16. Each client process requires a separate connection.

## Supported Network Protocols

The E5810B uses the network IP and Ethernet protocols listed in [Table 5-1](#). Refer to “[Glossary](#)” for more information on these protocols.

**Table 5-1** Supported network protocols

Name	RFC	Role	When	Description
ARP	826	Peer	As needed	Maps the IP address to the Ethernet address.
DHCP	2131, 2132	Client	Power-up	E5810B requests the IP configuration information.
DNS	1035	Client	As needed	E5810B resolves the DNS names to the IP addresses.
FTP	959	Client	Upgrade	Downloads new firmware into the E5810B.
HTTP	1945, 2068	Server	User setup	Web pages or forms for the E5810B configuration.
ICMP	792	Server	As needed	E5810B answers ECHO requests (ping).
RPC	1831, 1832, 1833	Server	User	Controls GPIB instruments using VXI-11.
Telnet		Server	User setup	E5810B configuration. Refer to <a href="#">Appendix A</a> , “Using the Telnet Utility” for more information

## **5 Characteristics and Specifications**

### Supported Network Protocols

**THIS PAGE HAS BEEN INTENTIONALLY LEFT BLANK.**





## A Using the Telnet Utility

Using the Telnet Utility	112
Telnet commands for E5810B	115
Telnet Command Comparison	117

This chapter explains how to access and exit the Telnet utility. It also summarizes various Telnet commands you can use with the E5810B.



# Using the Telnet Utility

For backward compatibility with the E2050 LAN/GPIB Gateway, the Telnet utility functionality is provided with the E5810B. However, E5810B Web access is the preferred method to configure the E5810B.

### Use the following procedure to access the Telnet utility.

- 1 If you are on a Windows XP computer system, follow the steps below:
  - From the Windows XP taskbar, select **Start > All Programs > Accessories > Command Prompt**.
  - The MS-DOS window opens.
- 2 From the MS-DOS window, type `telnet IP_address`, where `IP_address` is the IP address of the E5810B, and then press **Enter**.
- 3 When you are connected to the E5810B Telnet utility, you will see a list of the main Telnet commands and current configuration values for this E5810B.
- 4 You may also need to adjust the Local Echo in the Terminal Preferences dialog box so the Telnet utility will properly display your typed input. To do this, follow the steps below:
  - From the menu at the top of the Telnet window, select **Terminal > Preferences**. The Terminal Preferences dialog box is displayed.
  - Select the **Local Echo** check box to change it.
- 5 Select **OK** to close the Terminal Preferences dialog box.

**Use the following procedure to exit the Telnet utility.**

- 1** If you want to exit without saving any changes (if any) you have made to the configuration values, type `bye`, `exit` or `quit` at the Telnet prompt (`>`).
- 2** If you want to save the changes you have made to the configuration values via the Telnet utility, type `reboot` at the Telnet prompt (`>`).

**CAUTION**

Any client operations in progress and client connections will be terminated by the `reboot` command.

To reset the E5810B to the default configuration values and reboot the E5810B, type `factory-reset` at the Telnet prompt (`>`).

**CAUTION**

Any client operations in progress and client connections will be terminated by the `factory-reset` command when it reboots the E5810B.

A typical display screen for an E5810B is shown below. The configuration values you see for your E5810B will probably be different.

```
Welcome to the E5810B LAN/GPIB/USB Gateway Configuration Utility.
```

```
Controls GPIB, RS-232 and USB interfaces via the LAN
```

```
Commands
```

```
?                View Available Commands
exit, quit       Exit WITHOUT Saving Configuration Changes (see restart)
restart          Save Configuration Changes and Restart E5810B
status           View the LAN/GPIB/USB Gateway Connection Status
```

```
Read-only E5810B Parameters
```

```
hardware-addr:  44E8A5000121      # Ethernet (MAC) Address
serial-num:     MY50360021        # Serial Number
```

## A Using the Telnet Utility

### Using the Telnet Utility

```
model:                E5810B                # Product model
```

#### Configurable Parameters saved in E5810B non-volatile-memory

(Note: Some E5810B current values "in-use" maybe be different)

```
dhcp:                ON                    # Configure LAN for DHCP boot
ip:                  169.254.58.10          # Internet Protocol (IP) Address
subnet-mask:        255.255.0.0           # Network Subnet Mask
gateway:            0.0.0.0               # Network Gateway

dns_server:         0.0.0.0               # DNS Server
hostname:           None                  # Internet Hostname

description:        Agilent E5810B        # Description Description (UPnP
                    (44:E8:A5:00:01:21)   # Friendly Name)
upnp:               ON                    # Configured as UPNP device

lan-timeout:        720                   # LAN Timeout (Keepalive) in sec
io-timeout:         120                   # I/O Timeout in sec

gpib-name:          gpib0                 # GPIB SICL Interface Name
gpib-address:       21                    # GPIB System Controller Address
gpib-unit:          7                     # GPIB Logical Unit (LU) Number

rs232-name:         COM1                  # RS-232 SICL Interface Name
rs232-baud:         9600                  # RS-232 Baud Rate
rs232-bits:         8                     # RS-232 Bits
rs232-stopbits:    1                     # RS-232 Stop Bits
rs232-parity:       NONE                   # RS-232 Parity
rs232-flow:         NONE                   # RS-232 Flow Control
rs232-srq:          RI                     # RS-232 SRQ

usb-name:           usb0                  # USB SICL Interface Name
```

## Telnet commands for E5810B

Table A-1 lists the Telnet commands you can use with the E5810B. You should use the Telnet configuration commands only if you are using the Telnet configuration method to configure the E5810B. You can see a summary of all Telnet commands online by typing “?” at any time within the Telnet utility.

**Table A-1** Telnet commands

Command	Description
help	View Help Information
?	View Available Commands
config	View Configured Settings
model	View the Product Model
serial-num	View the Device Serial Number
version	View the Firmware Revision
hardware-addr	View the Ethernet (MAC) Address
dhcp <ON OFF>	Turn OFF or ON the use of DHCP
ipaddr <IP Address>	View/Set the IP Address
subnet-mask <IP Address>	View/Set the Network Subnet Mask
gateway <IP Address>	View/Set the Gateway Address
dns-server <IP Address>	View/Set the DNS Server Address
host-name <string*35>	View/Set the Internet Hostname
description <string*40>	View/Set Device Description (UPnP Friendly Name)
upnp <ON OFF>	Turn OFF or ON the use of UPnP
lan-timeout <seconds>	View/Set the LAN Timeout(Keepalive). 0 is Off.
io-timeout <seconds>	View/Set the Server I/O Timeout. 0 is Off.
gpib-name <string*15>	View/Set the GPIB SIDL Interface Name

## A Using the Telnet Utility

Telnet commands for E5810B

**Table A-1** Telnet commands (continued)

<b>Command</b>	<b>Description</b>
gplib-address <0-30>	View/Set the GPIB System Controller Address
gplib-unit <2-255>	View/Set the GPIB Logical Unit Number
rs232-name <string*15>	View/Set the RS-232 SICL Interface Name
rs232-baud <300 1200 2400 4800 9600 19200 38400 57600 115200>	View/Set Baud
rs232-bits <5 6 7 8>	View/Set number of RS-232 data Bits
rs232-stopbits <1 2>	View/Set number of RS-232 Stop Bits
rs232-parity <NONE EVEN ODD MARK SPACE>	View/Set the RS-232 Parity
rs232-flow <NONE XON RTS DTR>	View/Set the RS-232 Flow Control
rs232-srq <RI DSR DCD CTS>	View/Set the RS-232 SRQ Line
usb-name <string*15>	View/Set the USB SICL Interface name
status	View the LAN/GPIB Gateway Connection Status
syslog-display	View Contents of the Syslog
syslog-clear	Clear the Syslog
password	Enter the password (when prompted) (Password is required when making changes)
changepassword	Change the Password (when prompted)
restart	Save Configuration and Reboot E5810B
factory-reset	Reset Config to Factory Defaults and Reboot
exit	Exit WITHOUT Saving Configuration (see restart)
quit	Exit WITHOUT Saving Configuration (see restart)
bye	Exit WITHOUT Saving Configuration (see restart)

## Telnet Command Comparison

**Table A-2** Telnet command comparison

E5810A command	E5810B command	Comparison	Example
ip	ipaddr	<ul style="list-style-type: none"> <li>The usage is identical but the command is different.</li> </ul>	<ul style="list-style-type: none"> <li>ipaddr 192.168.0.1 <b>ip: 192.168.0.1 # Internet Protocol (IP) Address (modified)</b></li> <li>ipaddr <b>ip: 192.168.0.1 # Internet Protocol (IP) Address</b></li> </ul>
reboot	restart	<ul style="list-style-type: none"> <li>The usage is identical but the command is different.</li> <li>For E5810B, password is required before confirmation of exit.</li> <li>For E5810B, the 'reboot' command is still applicable. This command will reboot without saving the configuration.</li> </ul>	<ul style="list-style-type: none"> <li>restart <b>Please enter the password (default is E5810):</b> <b>The restart command will save changes and close open connections/sessions. Are you sure that you want to Restart the E5810 (y/n) ?</b></li> </ul>
password	password	<ul style="list-style-type: none"> <li>The command is identical but the usage is different.</li> <li>For E5810B, password is not required when making changes. The command will check if the entered password is correct.</li> </ul>	<ul style="list-style-type: none"> <li>password <b>Please enter the password (default is E5810):</b></li> </ul>
hostname	host-name	<ul style="list-style-type: none"> <li>The usage is identical but the command is different.</li> <li>For E5810B, the 'hostname' command is still applicable. The hostname will not be rebroadcasted immediately and the hostname will be reset after reboot.</li> </ul>	<ul style="list-style-type: none"> <li>host-name E5810B <b>hostname: E5810B # Internet Hostname (modified)</b></li> <li>host-name <b>hostname: E5810B # Internet Hostname</b></li> </ul>

**A Using the Telnet Utility**  
Telnet Command Comparison

**THIS PAGE HAS BEEN INTENTIONALLY LEFT BLANK.**



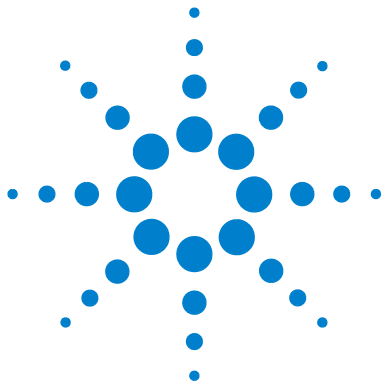

## Glossary

- A 121
  - Address 121
  - ASRL 121
- B 121
  - Bridge 121
- C 122
  - Client 122
  - Controller 122
- D 122
  - Device 122
  - DHCP 123
  - DNS 123
- E 124
  - Ethernet (MAC) address 124
- F 124
  - Friendly name 124
- G 124
  - Gateway 124
  - Gateway IP address 125
- H 125
  - Hostname 125
  - Hub 125
- I 126
  - Instrument 126
  - Interface 126
  - IP address 127
- L 128
  - LAN 128
  - Lock 129
  - Logical unit 129
- N 130



## Glossary

- Network protocols 130
- P 131
  - Proxy server 131
- R 132
  - Router 132
  - RS-232 132
- S 133
  - Server 133
  - SICL 133
  - SRQ 133
  - Subnet 134
  - Subnet mask 134
  - Switch 135
  - Symbolic name 135
- U 136
  - Universal Plug and Play 136
- V 137
  - VEE 137
  - VISA 137
  - VISA COM 137

## A

### Address

Address is a unique string identifying a particular interface or a device on that interface which is interpreted at the E5810B LAN/GPIB/USB Gateway to identify the interface or device.

### ASRL

For the E5810B, ASRL is synonymous with the RS-232 interface. Refer to [RS-232](#) for more information.

## B

### Bridge

In telecommunication networks, a bridge is a product that connects a local area network (LAN) to another LAN that uses the same protocol (for example, Ethernet or a token ring). You can envision a bridge as being a device that decides whether a message from you to someone else is going to the LAN in your building or to someone on the LAN in the building across the street. A bridge examines each message on a LAN, passing those known to be within the same LAN, and forwarding those known to be on the other interconnected LAN or LANs.

## C

### **Client**

Client is part of the client/server model used in distributed computing. A client is a computer system that requests services from a server computer system, such as I/O application requests, and networking requests.

### **Controller**

Controller is a computer used to communicate with a remote device such as an instrument. In the communications between the controller and the device, the controller is in charge and controls the flow of communication. The controller does the addressing and/or other bus management, and acts as the remote I/O client to the E5810B server.

## D

### **Device**

Device is a unit that receives commands from a controller. Typically a device is an instrument but could also be a computer acting in a non-controller role, or another peripheral such as a printer or a plotter.

## DHCP

Dynamic Host Configuration Protocol (DHCP) is a protocol for assigning dynamic IP addresses to devices on a network. With dynamic addressing, a device can have a different IP address every time it connects to the network.

In some systems, the device's IP address can even change while it is still connected. DHCP also supports a mix of static and dynamic IP addresses.

Dynamic addressing simplifies network administration because the software keeps track of the IP addresses rather than requiring an administrator to manage the task. This means that a new computer can be added to a network without manually assigning it to a unique IP address. DHCP client support is built into Windows workstations.

## DNS

Domain Name System or Service (DNS) is an Internet service that translates domain names into IP addresses. Domain names are easier to remember as they are alphabetic. However, the Internet is based on IP addresses. Every time you use a domain name, a DNS service must translate the name into the corresponding IP address.

For example, the domain name `www.example.com` might be translated to `198.105.232.4`. The DNS system is a distributed system. If one DNS server does not know how to translate a particular domain name, it will ask another DNS server, and so on, until the correct IP address is returned.

## E

### **Ethernet (MAC) address**

The Media Access Control (MAC) address is also known as the link-level address, the Ethernet (station) address, the LANIC ID, and hardware address. This is a unique 48-bit address assigned by the manufacturer for each Ethernet device. It is usually displayed in a 12 hexadecimal characters, sometimes with colon or dash separators between every two characters, such as 00:03:d3:00:00:17 or 00-03-d3-00-00-17.

## F

### **Friendly name**

Friendly name is the UPnP friendly name of the E5810B that will automatically be displayed on the Universal Plug and Play (UPnP) enabled LAN hosts. When the E5810B is connected to the LAN, it broadcasts its presence to the network if the UPnP is enabled. UPnP clients will then see the name and description of this E5810B in My Network Places. A friendly name can be up to 39 characters including spaces.

## G

### **Gateway**

Gateway is a hardware that permits a network connection between the LAN that your computer understands and the instrument specific interface that your device understands.

## Gateway IP address

Gateway IP address is the IP address of the default subnet gateway that allows the E5810B to communicate with systems that are not on the local subnet. Thus, this is the default subnet gateway where packets are sent and are destined for a device not on the local subnet, as determined by the subnet mask setting. Only one default subnet gateway can be configured. A value of 0.0.0.0 indicates that no subnetting is configured.

## H

### Hostname

Hostname is the Internet domain name for the E5810B. Depending on the type of servers in the network, you may be able to use this name to communicate with the E5810B. However, since you can always use the IP address or the name supplied by another server name, the hostname is not a required configuration value.

You may enter up to 15 characters for the hostname. The hostname must start with a letter and consists of upper and lower case letters, digits, and dashes. The default hostname is **E5810-** with the last four characters of the Ethernet (MAC) address, such as **E5810-e40c**.

### Hub

Hub is a common connection point for devices in a network. Hubs are commonly used to connect segments of a LAN. A hub contains multiple ports. When a packet arrives at one port, it is copied to the other ports so that all the LAN segments can see all the packets.

|

### **Passive hubs**

Passive hubs serve simply as a conduit for the data, enabling it to go from one device or segment to another.

### **Intelligent hubs**

Intelligent hubs include additional features that enables an administrator to monitor the traffic passing through the hub and to configure each port in the hub. Intelligent hubs are also called manageable hubs.

### **Switching hubs**

Switching hubs actually read the destination address of each packet and then forward the packet to the correct port.

|

## **Instrument**

Instrument is a device that accepts commands and performs a test or a measurement function.

## **Interface**

Interface is a connection and communication media between devices and controllers, including mechanical, electrical, and protocol connections.



## IP address

Internet Protocol (IP) address is an identifier for a computer or device on a TCP/IP network. Networks using the TCP/IP protocol route messages based on the IP address of the destination. The format of an IP address is a 32-bit numeric address written as four numbers separated by periods. Each number can be from 0 to 255. For example, 1.160.10.240 can be an IP address.

Within an isolated network, you can assign IP addresses at random as long as each one is unique. However, connecting a private network to the Internet requires using registered IP addresses to avoid duplicates. The four numbers in an IP address are used in different ways to identify a particular network and a host on that network. The InterNIC Registration Service assigns Internet addresses from the following three classes.

### **Class A**

Class A supports 16 million hosts on each of the 127 networks.

### **Class B**

Class B supports 65,000 hosts on each of the 16,000 networks.

### **Class C**

Class C supports 254 hosts on each of the 2 million networks.

## LAN

Local Area Network (LAN) is a computer network that spans a relatively small area. Most LANs are confined to a single building or a group of buildings. However, one LAN can be connected to other LANs over any distance via telephone lines and radio waves. A system of LANs connected in this way is called a Wide-Area Network (WAN).

Most LANs connect workstations and personal computers. Each node (individual computer) in a LAN has its own CPU with which it executes programs, but is also able to access data and devices anywhere on the LAN. This means that many users can share expensive devices, such as laser printers, as well as data. Users can also use the LAN to communicate with each other, by sending e-mail or engaging in chat sessions.

There are many different types of LANs and Ethernets being the most common for PCs. Most Apple Macintosh networks are based on Apple's AppleTalk network system, which is built into Macintosh computers. The following characteristics differentiate one LAN from another:

### **Topology**

Topology is the geometric arrangement of devices on the network. For example, devices can be arranged in a ring or in a straight line.

### **Protocols**

Protocols are the rules and encoding specifications for sending data. The protocols also determine whether the network uses a peer-to-peer or client/server architecture.

## Media

Media are devices that can be connected by a twisted-pair wire, coaxial cables, or fiber optic cables. Some networks can be connected via radio waves.

LANs are capable of transmitting data at very fast rates, much faster than data can be transmitted over a telephone line. However, the distances are limited and there is also a limit on the number of computers that can be attached to a single LAN.

## Lock

Lock is a state that prohibits other users from accessing a resource, such as a device or interface.

## Logical unit

Logical unit is a number associated with an interface. In Agilent SICL, a logical unit uniquely identifies an interface. Each interface on the controller must have a unique logical unit.

## N

### Network protocols

The E5810B supports these network protocols: ARP, DHCP, DNS, FTP, HTTP, ICMP, and RPC.

#### **ARP**

Address Resolution Protocol (ARP) is a TCP/IP protocol used to convert an IP address into a physical address (DLC address), such as an Ethernet address.

#### **DHCP**

Refer to [DHCP](#).

#### **DNS**

Refer to [DNS](#).

#### **FTP**

File Transfer Protocol (FTP) is the protocol used on the Internet for sending files.

#### **HTTP**

HyperText Transfer Protocol (HTTP) is the underlying protocol used by the World Wide Web (WWW). HTTP defines how messages are formatted and transmitted, and what actions Web servers and browsers should take in response to the various commands.

## ICMP

Internet Control Message Protocol (ICMP) is an extension to the Internet Protocol (IP) defined by RFC 792. ICMP supports packets containing error, control, and informational messages. The ping command, for example, uses ICMP to test an Internet connection.

## RPC

Remote Procedure Call (RPC) is a type of protocol that allows a program on one computer to execute a program on a server computer. Using RPC, a system developer does not need to develop specific procedures for the server. The client program sends a message to the server with the appropriate arguments and the server returns a message containing the results of the program executed.

# P

## Proxy server

Proxy server is a server that sits between a client application, such as a Web browser and a real server. It intercepts all requests to the real server to see if it can fulfill the requests itself. If not, it will forward the request to the real server. Proxy servers have two main purposes:

### Improve performance

Proxy servers can dramatically improve performance for groups of users, since a proxy server saves the results of all requests for a certain amount of time. Consider the case where both user X and user Y access the Web through a proxy server. First user X requests a certain Web page, which we will call Page 1. Sometime later, user Y requests the same page.

Instead of forwarding the request to the Web server where Page 1 resides, which can be a time-consuming operation, the proxy server returns the Page 1 it already fetched for user X. Since the proxy server is often on the same network as the user, this is a much faster operation. Real proxy servers support hundreds or thousands of users.

**Filter requests**

Proxy servers can also be used to filter requests. For example, a company might use a proxy server to prevent its employees from accessing a specific set of Web sites.

**R****Router**

Router is a device that connects any number of LANs. Routers use headers and a forwarding table to determine where packets go. They use Internet Control Message Protocol (ICMP) to communicate with each other and configure the best route between any two hosts. Very little filtering of data is done through routers. Routers do not care about the type of data they handle. Routers often have DHCP server capability.

**RS-232**

Recommended Standard-232C (RS-232) is a standard interface approved by the Electronic Industries Association (EIA) for connecting serial devices. The standard is referred to as RS-232C or RS-232.

A device that connects to an RS-232 interface is called a Data Communications Equipment (DCE) and the device to which it connects to, such as a computer, is called a Data Terminal Equipment (DTE).

The RS-232 standard supports two types of connectors – a 25-pin D-type connector (DB-25) and a 9-pin D-type connector (DB-9). The type of serial communications used by PCs requires only 9 pins so either type of connector will work equally well with PCs.

## S

### Server

Server is part of the client/server model used in distributed computing. A server is a computer system designated to act as a main servicer of requests from other client computer systems, such as I/O application requests, networking requests, and so forth.

### SICL

The Agilent Standard Instrument Control Library (SICL) is a software used for I/O application programming. SICL is part of the Agilent IO Libraries Suite.

### SRQ

Service Request (SRQ) is an asynchronous request or an interrupt from a remote device indicating that the device requires servicing.

## Subnet

Subnet is a portion of a network that shares a common address component. On TCP/IP networks, subnets are defined as all devices whose IP addresses have the same prefix. For example, all devices with IP addresses that start with 100.100.100. would be part of the same subnet. Dividing a network into subnets is useful for both security and performance reasons. IP networks are divided using a subnet mask.

## Subnet mask

Subnet mask is a mask used to determine what subnet an IP address belongs to. An IP address has two components – the network address and the host address. For example, consider that the IP address is 150.215.017.009. Assuming this is part of a Class B network, the first two numbers, 150.215 represent the Class B network address and the second two numbers, 017.009 identify a particular host on this network.

Subnetting enables a system administrator to further divide the host part of the address into two or more subnets. In this case, a part of the host address is reserved to identify the particular subnet.

For example, the full address for 150.215.017.009 is 10010110.11010111.00010001.00001001. The Class B network part is 10010110.11010111 and the host address is 00010001.00001001. If this network is divided into 14 subnets, the first four bits of the host address, 0001 are reserved for identifying the subnet.

The subnet mask is the network address plus the bits reserved for identifying the subnetwork. By convention, the bits for the network address are all set to 1, though it would also work if the bits were set exactly as in the network address. In this case, the subnet mask is 11111111.11111111.11110000.00000000.



It is called a mask because it can be used to identify the subnet to which an IP address belongs by performing a bitwise AND operation on the mask and the IP address. The result is the subnetwork address:

```
Subnet Mask 255.255.240.000  
11111111.11111111.11110000.00000000
```

```
IP Address 150.215.017.009  
10010110.11010111.00010001.00001001
```

```
Subnet Address 150.215.016.000  
10010110.11010111.00010000.00000000
```

The default subnet mask for the E5810B is 255.255.0.0.

## Switch

Switch is a device that filters and forwards packets between LAN segments. Switches operate at the data link layer (layer 2) and sometimes the network layer (layer 3) of the OSI Reference Model and therefore support any packet protocol. LANs that use switches to join segments are called switched LANs or, in the case of Ethernet networks, switched Ethernet LANs. A hub connects all the devices on its ports together. A switch is a bit smarter, as it understands when two devices (out of four, five, eight, sixteen, or even more) want to talk to each other and gives them a switched connection.

## Symbolic name

Symbolic name is a name corresponding to a single interface. This name uniquely identifies the interface on a controller or gateway. If there is more than one interface on the controller or gateway, each interface must have a unique symbolic name.

## U

### Universal Plug and Play

Universal Plug and Play (UPnP) is an open industry standard that uses Internet and Web protocols to enable devices such as PCs, peripherals, intelligent appliances, and wireless devices to be plugged into a network and automatically know about each other.

UPnP is an architecture for pervasive peer-to-peer network connectivity of PCs and intelligent devices or appliances. UPnP builds on Internet standards and technologies, such as TCP/IP, HTTP, and XML, to enable LAN devices to automatically connect with one another and work together.

With UPnP, when a user plugs a device into the network, the device will configure itself, acquire a TCP/IP address, and use a discovery protocol based on the Internet's Hypertext Transfer Protocol (HTTP) to announce its presence on the network to other devices. UPnP devices use Extensible Markup Language (XML) to establish a common language or protocol negotiation, to talk to each other and determine capabilities.

The E5810B has two options for Universal Plug and Play (UPnP):

#### **Option ON**

The E5810B is configured as a UPnP device and provides information to the network about itself via an XML description when mounted to the network.

#### **Option OFF**

The E5810B is not UPnP capable and will not announce its presence as a UPnP device when mounted to the network.

## V

### VEE

The Agilent Visual Engineering Environment (VEE) is a software used for I/O application programming.

### VISA

The Agilent Virtual Instrument Software Architecture (VISA) library is a software used for I/O application programming. Agilent VISA is part of the Agilent IO Libraries Suite.

### VISA COM

Common Object Model (COM) is an implementation of VISA. Agilent VISA COM is part of the Agilent IO Libraries Suite.

**THIS PAGE HAS BEEN INTENTIONALLY LEFT BLANK.**

**www.agilent.com**

**Contact us**

To obtain service, warranty, or technical assistance, contact us at the following phone or fax numbers:

United States:

(tel) 800 829 4444 (fax) 800 829 4433

Canada:

(tel) 877 894 4414 (fax) 800 746 4866

China:

(tel) 800 810 0189 (fax) 800 820 2816

Europe:

(tel) 31 20 547 2111

Japan:

(tel) 0120 (421) 345 (fax) 0120 (421) 678

Korea:

(tel) (080) 769 0800 (fax) (080) 769 0900

Latin America:

(tel) (305) 269 7500

Taiwan:

(tel) 0800 047 866 (fax) 0800 286 331

Other Asia Pacific Countries:

(tel) (65) 6375 8100 (fax) (65) 6755 0042

Or visit Agilent World Wide Web at:

[www.agilent.com/find/assist](http://www.agilent.com/find/assist)

Product specifications and descriptions in this document are subject to change without notice. Always refer to the Agilent Web site for the latest revision.

© Agilent Technologies, Inc. 2013–2014

Fourth Edition, March 25, 2014  
E5810-90004



**Agilent Technologies**