



Introduction

ASM 142 - ASM 142 D ASM GRAPH - ASM GRAPH D ASM GRAPH D+ Detailed contents

User's Manual

Preliminary remarks Throughout this User's Manual, you could find this type of message "Summary of screen  C 140": it refers to a specific chapter of the User's Manual. Please read it for further information.

A 100

Introduction to the ASM 142 series

A 200

ASM 142 - Detector operating principle

- Vacuum circuit
- Stand-by mode
- Roughing mode
- Gross leak test mode
- Normal test mode
- Sniffing test mode

A 201

ASM 142 D - Detector operating principle

- Vacuum circuit
- Stand-by mode
- Roughing mode
- Gross leak test mode
- Normal test mode
- Sniffing test mode

A 202

ASM 142 Graph D+ detector operating principle

- Vacuum circuit
- Stand-by mode
- Roughing mode
- Gross leak test mode
- Normal test mode
- Sniffing test mode

A 300

Analyzer cell operating principle

- Description
- Design and manufacture

A 400

Testing methods

- Overview
- Helium concentration and signal displayed
- Spray method (inboard testing)
- Sniffer method (outboard testing)
- Bombing method

A 401

About Helium and hydrogen

- Helium
- Helium and leak detection: which purity?
- Hydrogen

A 500

Operator interface : control panel



Introduction

ASM 142 - ASM 142 D ASM GRAPH - ASM GRAPH D ASM GRAPH D+ Detailed contents

User's Manual

A 600

Options

- Which options for which model?
- Metal seals
- Inlet port
- Units
- Languages
- 3 masses
- Automatic test chambers
- Roughing system
- Interface board
- Remote control cable length
- Test of gas line
- Stainless steel cover (UCT)
- Control panel with graphic interface
- Control panel racks
- Sniffing
- Câbles lengths

A 700

Accessories

- Which accessories for which model?
- Remote control
- Long Distance Sniffer probe
- 10 m/30 feet LDS extension
- Headphone connector
- Transport cart
- Foot pedal for cycle command (1.5 m/5 feet)
- Calibrated Helium leaks
- Calibration accessory
- Spray probe
- Inlet adaptator
- Printer
- Inlet filters
- Short distance sniffer probe (to be connected to the inlet part of a leak detector)
- Bombing chamber
- Test chambers (required interface board)
- Neutral gas vent line kit
- 4 swiveling wheels kit (Ø125 mm)
- Covered sniffer probe and remote control kit
- Bottle handle for cart
- Built-in mini-printer
- 2005 IS Pump
- Pressure measurement kit
- Ventilation Kit
- Bottle handle for cart

A 800

ASM 142 - Technical characteristics

A 801

ASM 142 D - ASM Graph D+ - Technical characteristics

A 900

Dimensions

A 901

Dimensions - ASM graph D+

Introduction to the ASM 142 series

A new generation of Adixen helium leak detector

The ASM 142/142 D/142 S/ASM Graph/ASM Graph D/ASM Graph D+ are universal helium leak detectors which set new performance standards for multi-purpose unit.

These detectors are the end-result of an innovative engineering approach utilizing the latest electronics technologies and vacuum concepts, which make them a truly universal unit:



Model photographed:
ASM 142

	ASM 142	ASM Graph	ASM 142 D	ASM Graph D	ASM 142 S	ASM Graph D+
■ high performances, such as, a roughing capacity of 7 CFM (60 l/mn) with a usable helium sensitivity in the 10 ⁻¹¹ atm.cc/sec range.	x	x				x
■ high performances, such as, a dry roughing capacity of 0.9 CFM (1.5 m ³ /h) with a usable helium sensitivity in the 10 ⁻¹¹ atm.cc/sec range.			x	x		x
■ a usable helium sensitivity in the 10 ⁻⁷ atm.cc/sec range (with auto-zero function).					x	
■ comprehensive control panel with two distinct areas (one for the operation of the unit, the other for entering the test parameters).	x	x	x	x	x	x
■ evolved features to assist the operator in his daily operation (auto-calibration, auto-zero, helium signal direct readout, ...).	x	x	x	x	x	x
■ very rugged design, based on field-proven components, which makes it ideal for any industrial environment.	x	x	x	x	x	x
■ various accessories to reinforce the versatility of the product (remote control, sniffer probe).	x	x	x	x	x	x
■ totally dry leak detector.			x	x		x
■ specific to sniffing test mode applications.					x	
■ graphic interface.		x		x		



We suggest that you read this manual before you start to use your detector to obtain optimum levels of performance and complete satisfaction.

ASM 142 detector operating principle

Vacuum circuit

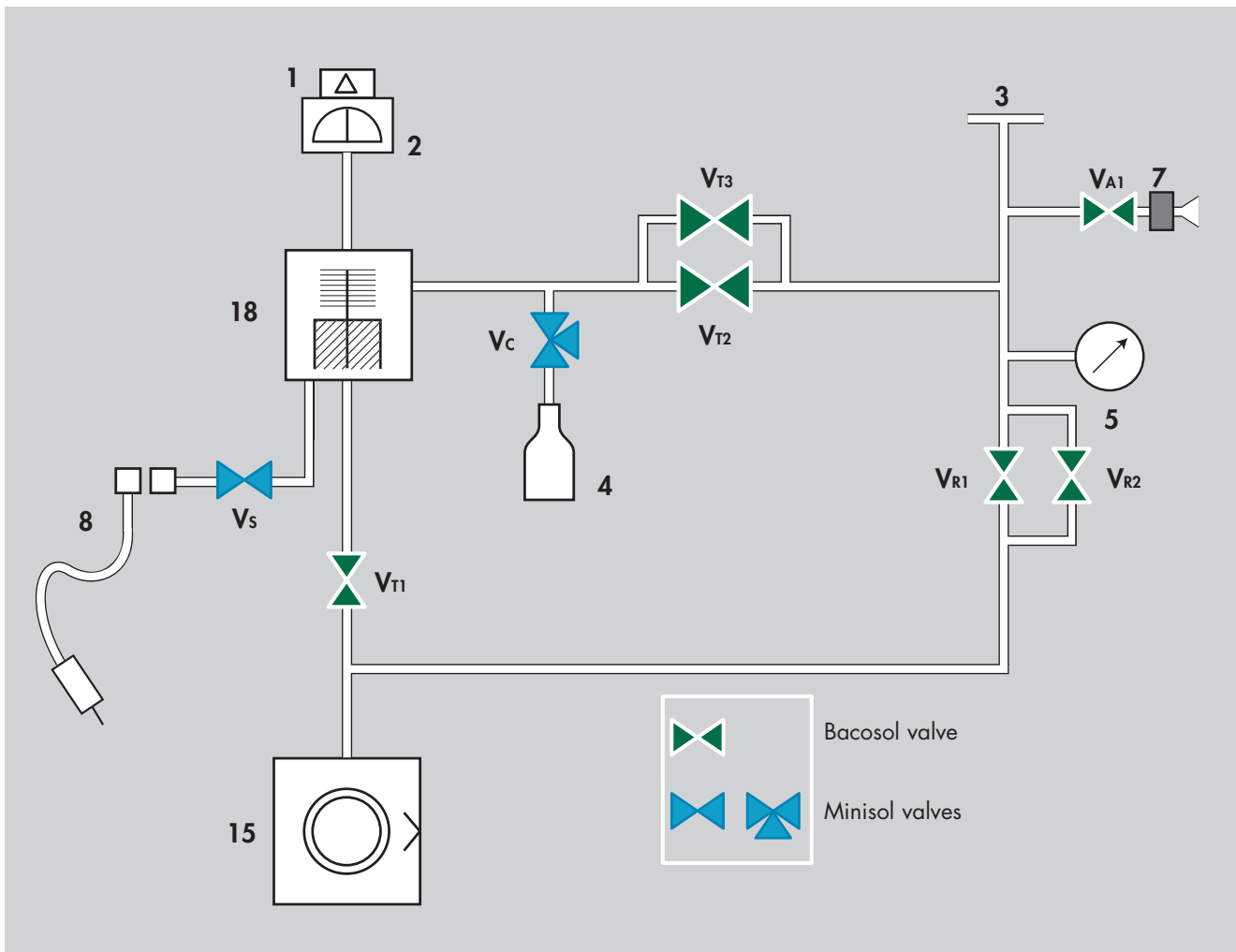

Reference correspondence between valve/vacuum block marks E 530

1	Preamplifier	VA1	Inlet vent valve (6 points)
2	Analyzer cell	VR1	Roughing valve (1 point)
3	Detector inlet port	VR2	Roughing valve (2 points)
4	Internal calibrated leak	VT1	Exhaust valve (3 points)
5	Inlet pressure gauge	VT2	Detection valve (4 points)
7	Vent connector	VT3	Detection valve (5 points)
8	Long distance sniffer connector	Vs	Sniffing valve (9 points)
15	Roughing primary pump (RVP 2010)	Vc	Calibration valve (7 points)
18	Detection molecular pump (AMP 0071)		

ASM 142 detector operating principle

Stand-by mode

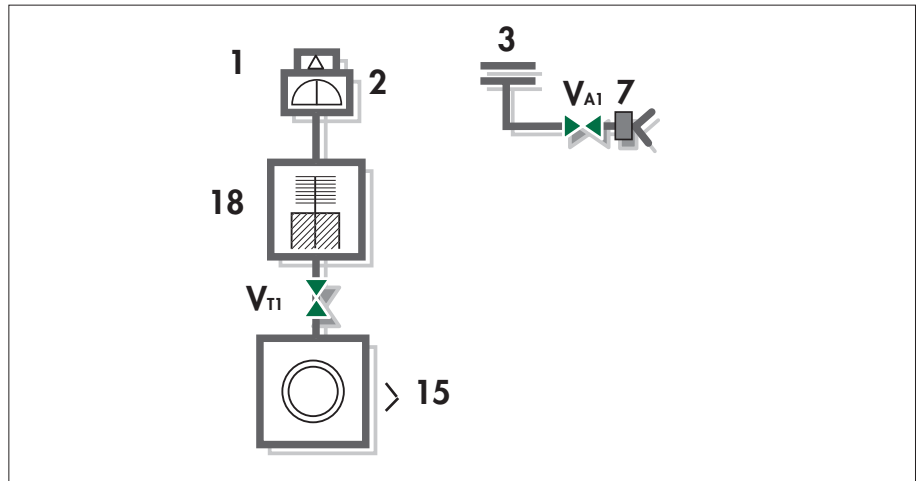

Roughing mode
(Patm to 10 mbar inlet pressure)

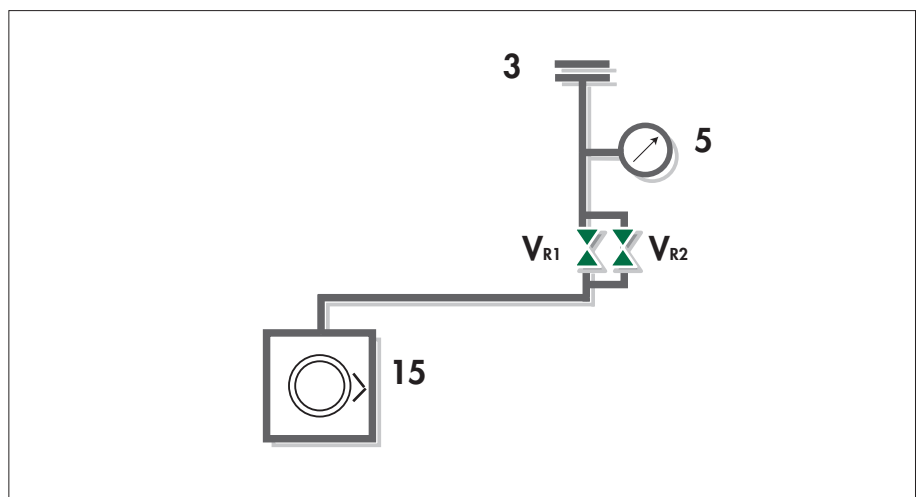

ASM 142 detector operating principle

Gross leak test mode
(10 mbar to 5×10^{-1} mbar inlet pressure)

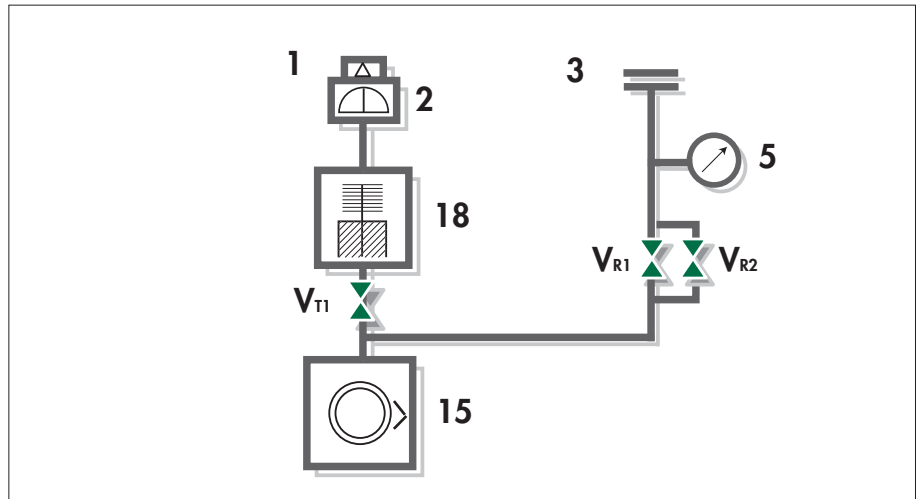

Normal test mode
(lower than 5×10^{-1} mbar inlet pressure)

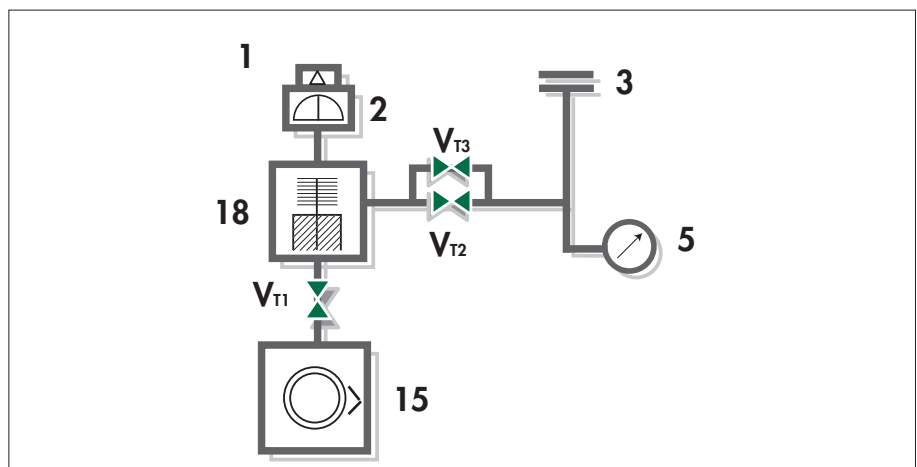

ASM 142 detector operating principle

Sniffing test mode

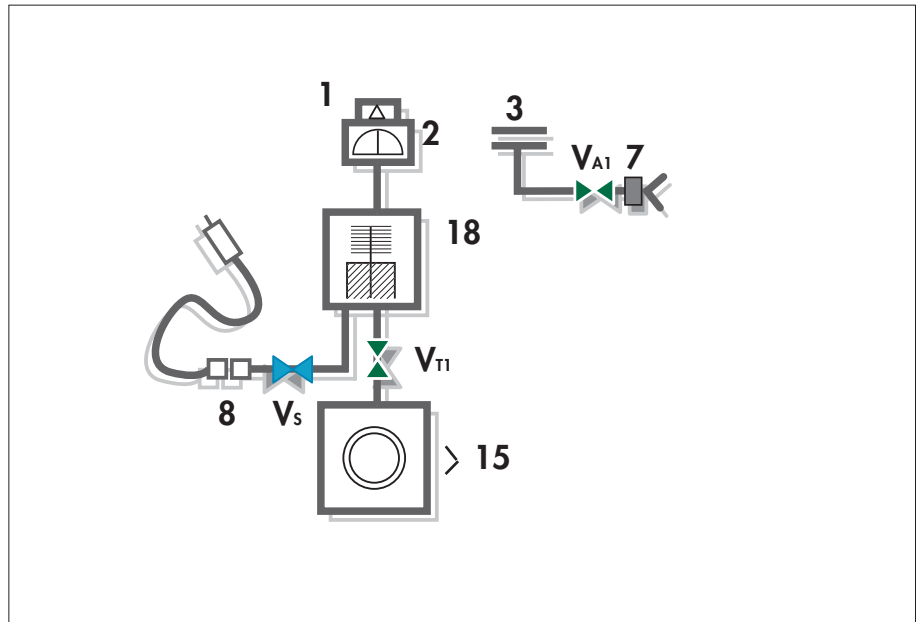

ASM 142 D detector operating principle

Vacuum circuit

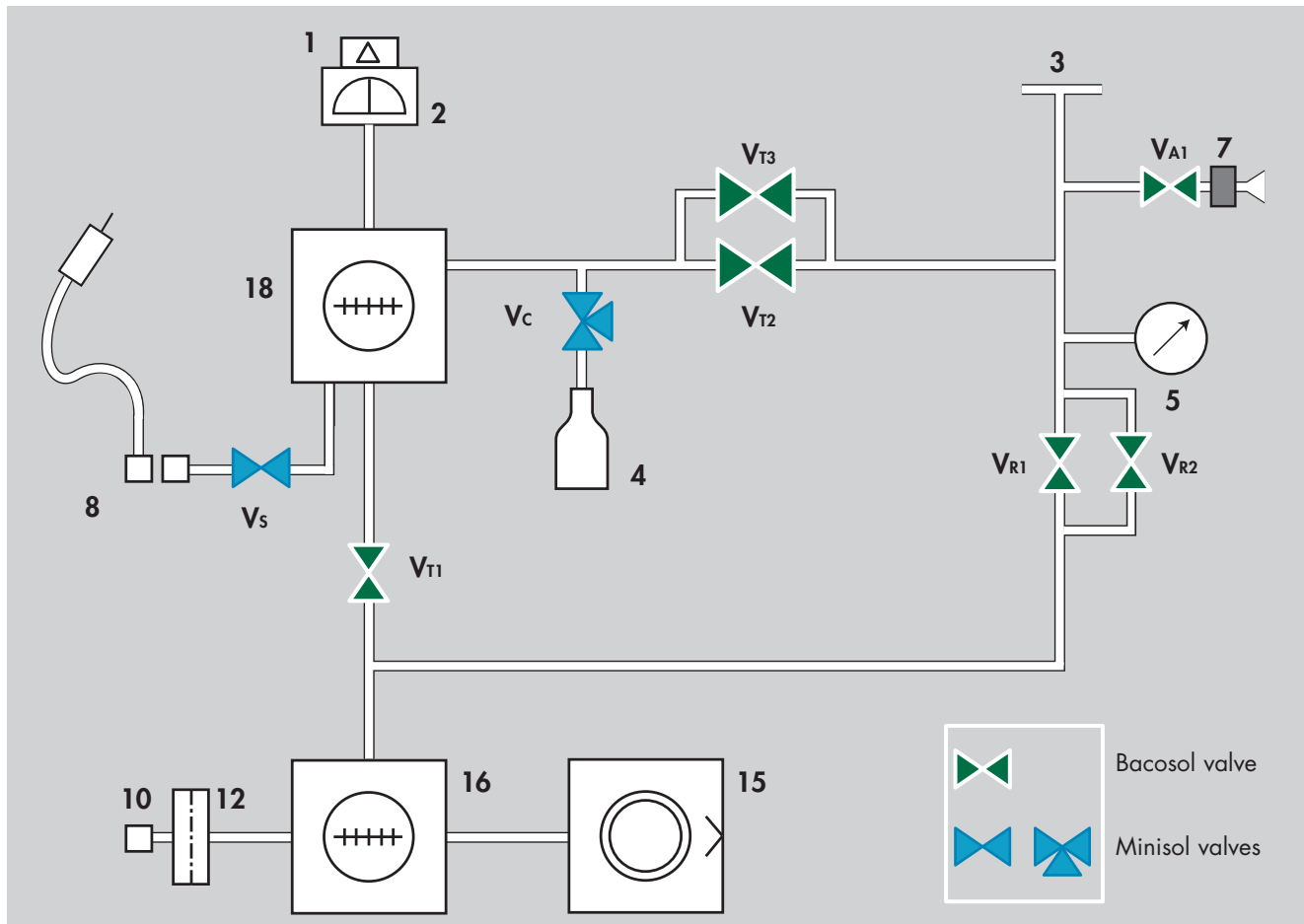

Reference correspondence between valve/vacuum block marks E 530

1	Preamplifier	VA1	Inlet vent valve (6 points)
2	Analyzer cell	VR1	Roughing valve (1 point)
3	Detector inlet port	VR2	Roughing valve (2 points)
4	Internal calibrated leak	VT1	Exhaust valve (3 points)
5	Inlet pressure gauge	VT2	Detection valve (4 points)
7	Vent connector	VT3	Detection valve (5 points)
8	Long distance sniffer connector	Vs	Sniffing valve (9 points)
10	Outlet pump connector	Vc	Calibration valve (7 points)
12	Purge filter		
15	Roughing pump (AMD1)		
16	Roughing molecular pump (MDP 5006 HDS)		
18	Detection molecular pump (AMP 007I)		

ASM 142 D detector operating principle

Stand-by mode

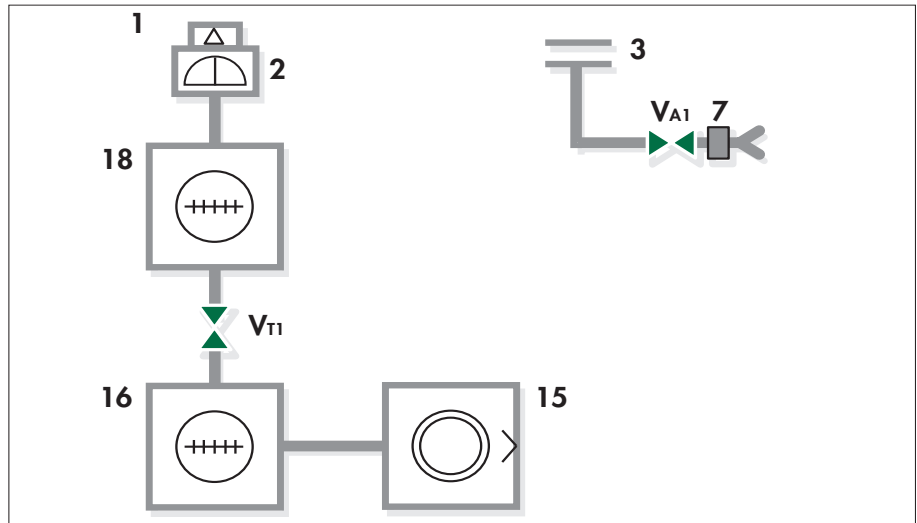

**Roughing mode
(Patm to 10 mbar inlet pressure)**

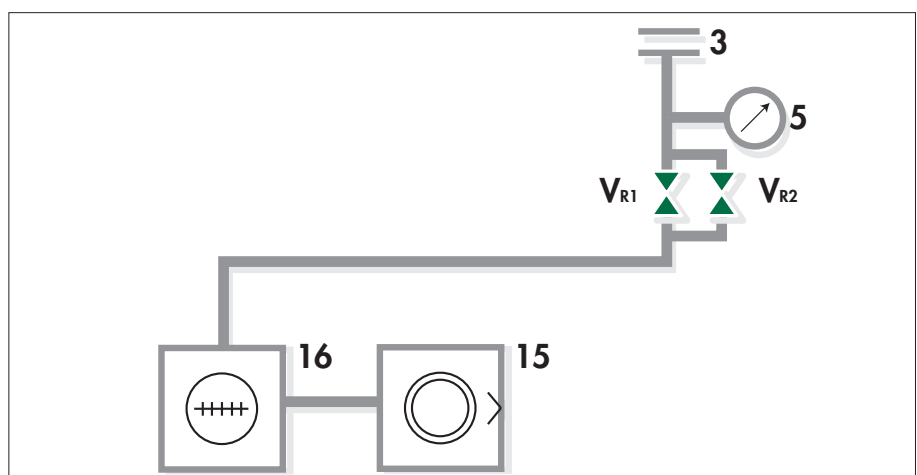

ASM 142 D detector operating principle

Gross leak test mode
 (10 mbar to
 5×10^{-1} mbar
 inlet pressure)

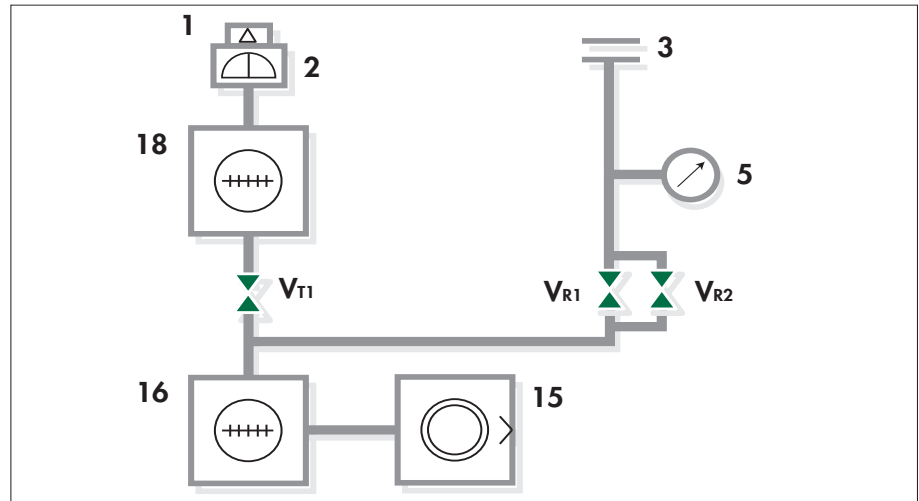

Normal test mode
 (lower than
 5×10^{-1} mbar
 inlet pressure)

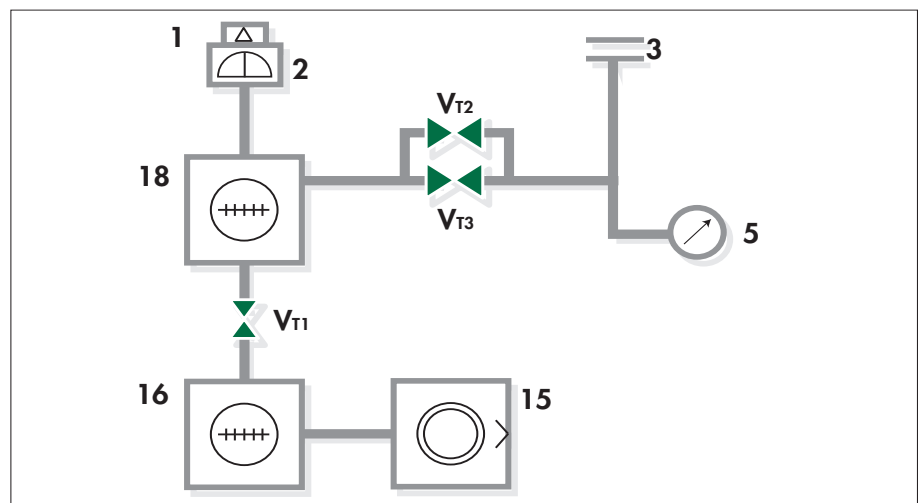

ASM 142 Graph D+ detector operating principle

Vacuum circuit

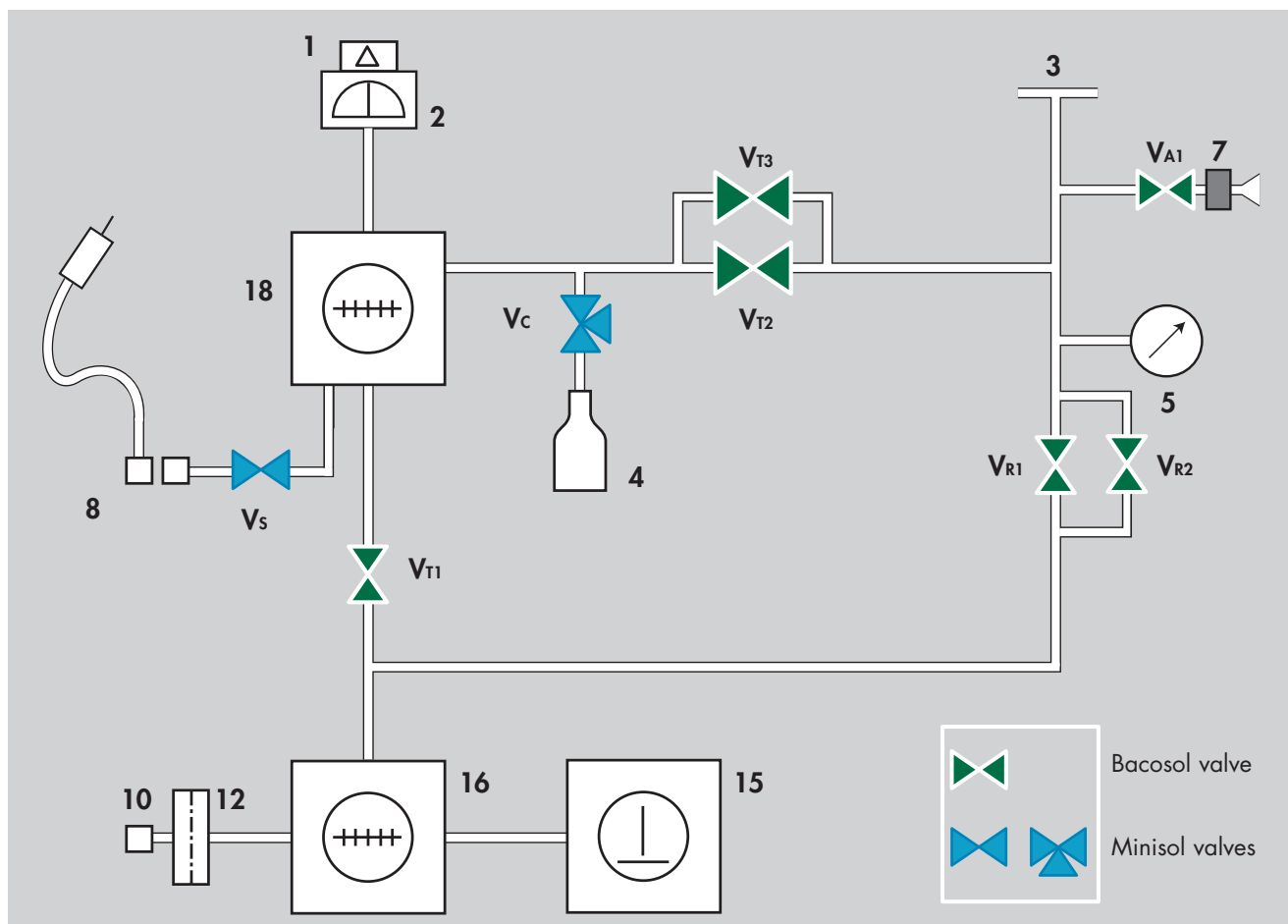

Reference correspondence between valve/vacuum block marks E 530

1	Preamplifier	VA1	Inlet vent valve (6 points)
2	Analyzer cell	VR1	Roughing valve (1 point)
3	Detector inlet port	VR2	Roughing valve (2 points)
4	Internal calibrated leak	VT1	Exhaust valve (3 points)
5	Inlet pressure gauge	VT2	Detection valve (4 points)
7	Vent connector	VT3	Detection valve (5 points)
8	Long distance sniffer connector	Vs	Sniffing valve (9 points)
10	Outlet pump connector	Vc	Calibration valve (7 points)
12	Purge filter		
15	Roughing primary pump (ACP 15)		
16	Roughing molecular pump (MDP 5006 HDS)		
18	Detection molecular pump (AMP 0071)		

ASM 142 Graph D+ detector operating principle

Stand-by mode

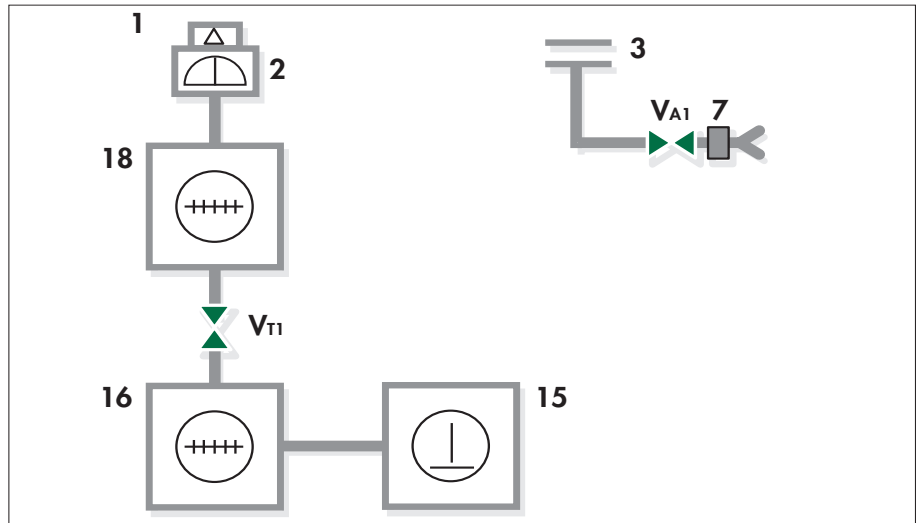

Roughing mode
(Inlet pressure: P_{atm}
to 10 mbar)

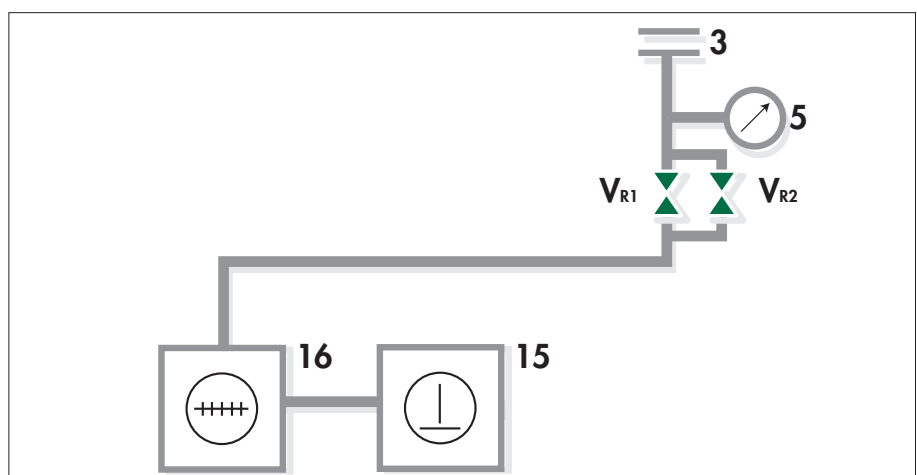

ASM 142 Graph D+ detector operating principle

Gross leak test mode
 (Inlet pressure:
 10 mbar to
 5×10^{-1} mbar)

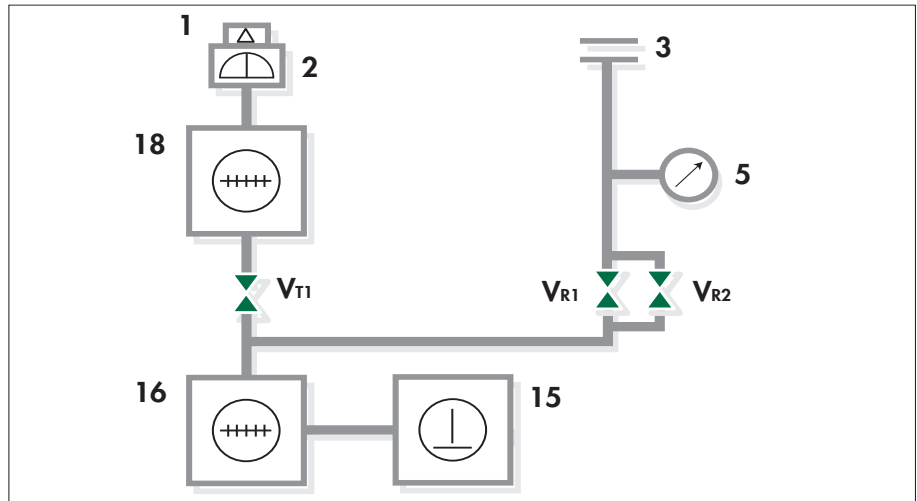

Normal test mode
 (Inlet pressure: lower
 than 5×10^{-1} mbar)

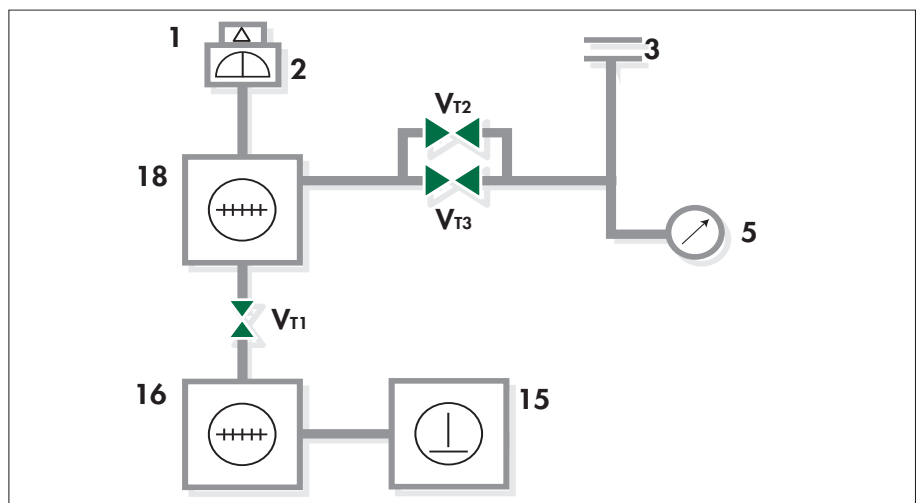

ASM 142 Graph D+ detector operating principle

Sniffing test mode

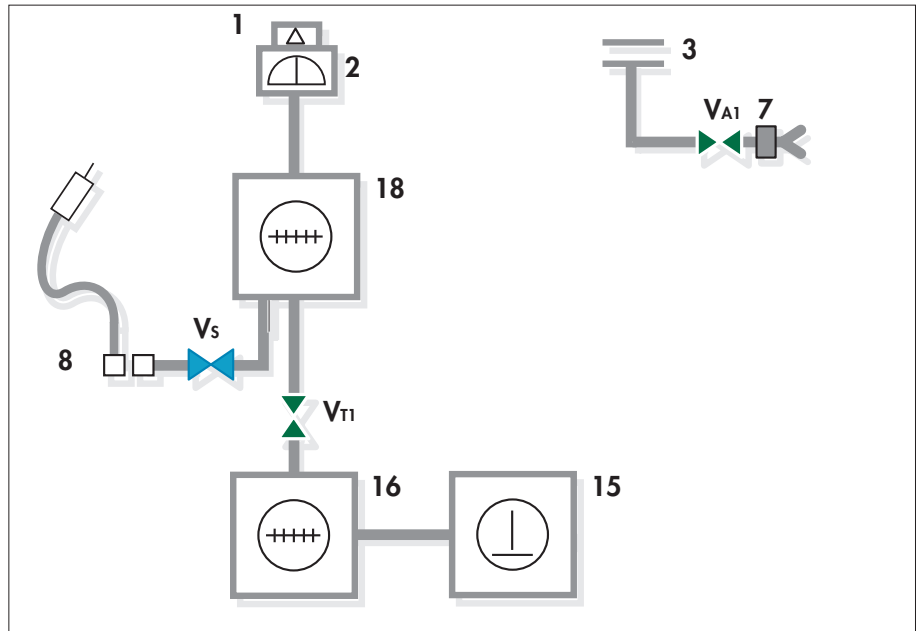

Analyzer cell operating principle

Description The analyzer cell works on the principle of mass spectrometry and is set to the mass of helium ($m/e = 4$).

m/e = atomic mass of the particle/number of electrons lost on ionization

The principle of magnetic deflexion spectrometry is as follows. The neutral molecules of the gas being analyzed pass into an ionization chamber (or source of ions) where they are bombarded by an electron beam generated by a heated tungsten filament. A large number of the molecules are transformed into ions.

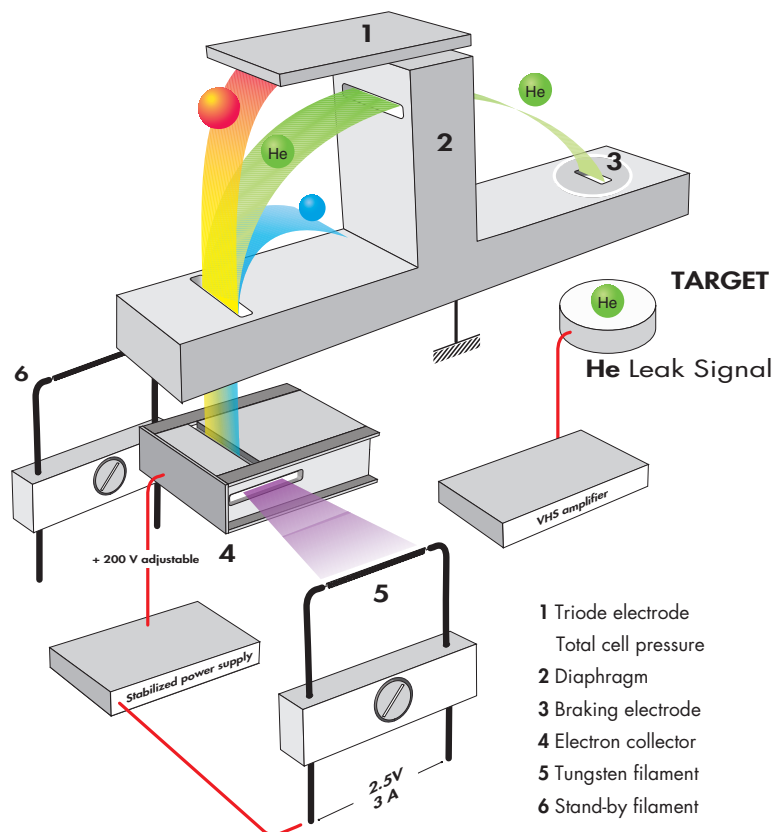

 **Electrons beam**

 **"heavy" ions**

 **Helium ions**

 **"light" ions**

Analyzer cell - functional diagram

Analyzer cell operating principle

Description (continued) These ionized particles are accelerated by an electrical field.

The entire analyzer cell is subject to a magnetic field which has the property of deflecting the trajectories of the ions along different curves according to the masses of those ions (to be more precise, according to their m/e ratios). Thus the ions beam, which contained ions with different masses, is divided into several beams, each containing only ions with the same m/e ratio. The helium ions ($m/e = 4$) are separated from the lighter (H_2^+ or H_1^+ , smaller beams) or heavier ions (N_2^+ or O_2^+ , small beams).

Because there is a constant magnetic field (permanent magnet), the accelerator electrical field is adjusted so that the helium ions ($m/e = 4$) follow a pre-determined trajectory (passing through diaphragms) and arrive on the target at the input to a direct current amplifier.

The current of helium ions is proportional to the partial pressure of helium in the installation and by measuring it we can find the flow rate of the leak that has been detected.

It is essential that the total pressure in the analyzer cell is less than 10^{-4} mbar, so that the trajectories of the electrons and the ions are not disturbed by residual molecules. Around 10^{-3} mbar there is a risk of damaging the heated filament.

In order to separate the helium ions from «noise» caused by «stray ions», an electrode located in front of the target eliminates the secondary ions with low energies. This electrode is called the «braking electrode».

There is an auxiliary electrode at the top of the cell, shaped like a plate, which collects the ions that are heavier than helium. This electrode thus measures the total pressure in the analyzer. This electrode serves as the plate for a triode gauge, hence its name of «triode electrode».

Analyzer cell operating principle

Design and manufacture

Great care has been taken with the design and manufacture of the cell in order to repeatedly obtain the same characteristics and to achieve excellent stability:

- the metal parts are made of stainless steel,
- the filament holder is made of machined aluminium,
- there is an integral amplifier.

The cell assembly is composed of:

- a vacuum chamber or deflection chamber,
- an optic holder flange,
- a permanent magnet,
- an amplifier.

- **The vacuum chamber:**

The analysis cell vacuum chamber is made of light alloy. It is hollow with a rectangular opening into which the electrodes, (that are installed on the «optics holder» flange) are placed.

- **The optics holder flange:**

The optics holder flange supports all the electrodes and electrical connections in the cell. They include:

- the sealed power supply socket, mounted on a metal gasket,
- the amplifier, mounted on an elastomer gasket,
- the supporting block which screens the target and on which the source of ions is mounted,
- the source of ions, which is made up of 2 parts:
 - a filament holder,
 - an ionization chamber with a stainless steel electron collector and a mass ion emitter.

The filament holder mechanically positions the tungsten filament with respect to the ionization chamber.

The electron collector and the filament have been designed and positioned so that the temperature of the electron collector stabilizes at 400°C under bombardment and radiation from the filament. The cell is thus rendered immune to contamination from the pieces being tested without the need of any special heating system.

Testing methods

Overview Leak detection is used to detect micro-openings, porosities, etc. in test parts. The detection of these cracks involves the use of a light tracer gas, which is capable of infiltrating the smallest leak quickly: **Helium**.

The detector samples and measures the helium flow rate entering the test part via the leak(s).

The testing method is selected according to the test part and the measurement accuracy required:

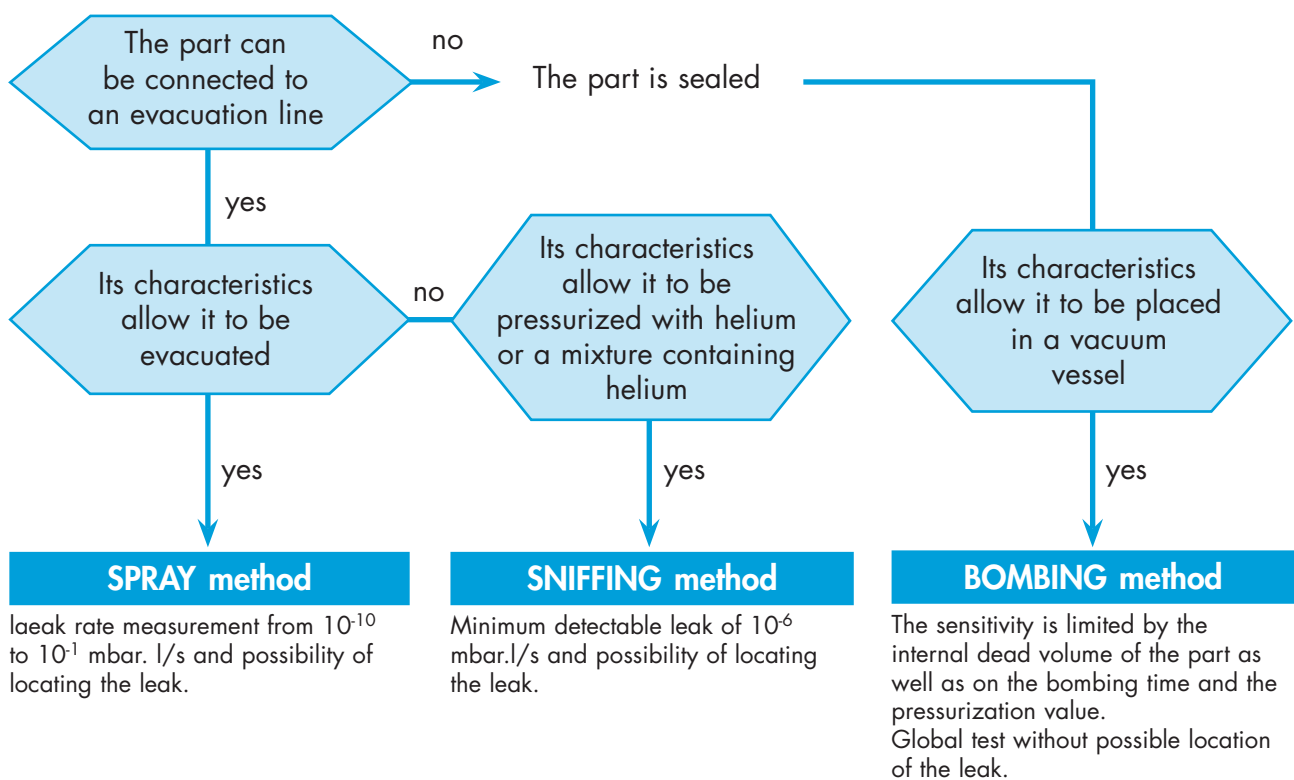

Testing methods

Helium concentration and signal displayed

In accordance to the He concentration rate in the gas used for the leak detection, the signal displayed will change.

Example: signal displayed with a 1×10^{-7} mbar.l/s calibrated leak (with 100 % He) connected to the detector inlet.

% He in the gas used	100 %	10 %	1 %
Signal displayed on the leak detector	1×10^{-7} mbar.l/s	1×10^{-8} mbar.l/s	1×10^{-9} mbar.l/s

Spray method (inboard testing)

This involves removing air from the test part, connecting it to the analyzer and then spraying helium over the outer surface.

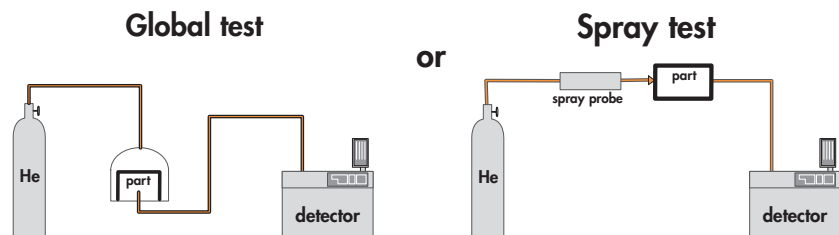

The part is placed under a cover, into which helium is injected.

Potential leaking areas are sprayed with helium.

The leak cannot be located.

The leak can be located.

The detector measures the flow of helium penetrating the part.

Response time

When spraying starts, the leak signal is not displayed instantaneously on the analyzer:

there is a response time which depends on the volume V being tested and the helium pumping speed S of the system at the opening of the part, according to the following relation:

$$T = V/S \quad (T \text{ in seconds, } V \text{ in litres, } S \text{ in l/s})$$

T is the time required for the signal to reach 63 % of the final value.

Testing methods

Sniffer method (outboard testing)

The test part is pressurized with helium. The detector, via an LDS (Long Distance Sniffer) probe, samples the helium escaping from the part.

Global test

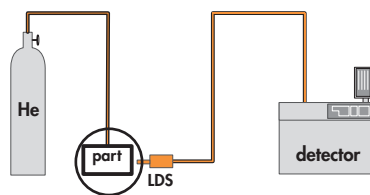

The part is placed under a cover containing a sniffer probe.

The leak cannot be located.

The helium from the leak accumulates over time inside the cover. The detector measures the concentration of helium.

Local sniffing test

or

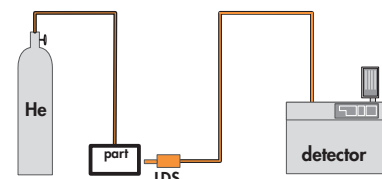

The sniffer probe is moved over areas likely to contain leaks.

The leak can be located.

The signal supplied by the analyzer is not a direct measurement of the leak. The sniffer probe only samples part of the helium escaping from the part. The sample depends on the distance separating the leak from the tip of the probe.

Testing methods

Bombing method

This method is used for sealed objects that cannot be connected directly to the detector (semiconductors, waterproof watches, etc.).

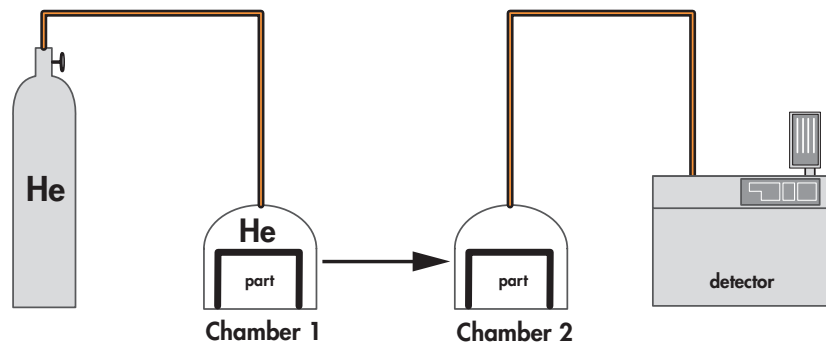

The part is placed in a chamber containing pressurized helium.

The helium penetrates the part if it has a leak.

The part is then removed from the chamber and placed in another vacuum chamber which is connected to the detector. The helium escapes from the part through the leak and produces a signal.

This signal is not a direct measurement of the leak as the helium pressure inside the part is difficult to determine. Several parts play an important part such as: the pressurization time, the helium bombing pressure, the internal volume, the aeration time, the size of the leak.

About Helium and hydrogen

Helium Helium is the second most common element in the universe, representing about 23 % of the total matter. 76 % is Hydrogen. All other elements represent an insignificantly small fraction of the total.

Helium was discovered by spectroscopy in a solar eclipse on August 18, 1868. The discovery in the sun's chromosphere gave the new element its name: "helios" in Greek means "sun". While Helium is very common in the universe most of it is in the stars: on earth it is actually not abundant. Since it is so light all the Helium present during the formation of earth escaped to space. Helium is created, deep in the earth from the radioactive decay of Uranium and Thorium which also generates the earth its internal heat. On earth Helium was discovered in 1881 by spectroscopy of Mount Vesuvio in Italy – the volcanic gases emanated by the mountain showed the same lines in the spectrum as already known from the sun.

Helium concentration in the atmosphere is 5 times bigger than the one of Krypton and 60 times higher than Xenon. The heavier noble gases are isolated from air by liquefaction and rectification process. Helium as a contrary is "extracted" from natural gas and oil wells. Helium comes up with the natural gas and is separated and stored. The annual world wide production is ca. 3×10^7 m³ or 4,500 tons.

Helium is constantly seeping up from the ground all around us, but it is so light that almost all of it escapes into space fairly rapidly. On the other hand there is a constant flow of Helium from space and the sun to earth. This gives a dynamic equilibrium and is the reason for the world wide constant concentration of ca. 5 ppm Helium in air.

Helium is a very light colorless element and it is one of the six noble gases; it is the most difficult gas to liquefy.

Helium is a noble gas, which means it doesn't react with anything for all practical intents and purposes. It's used as an inert shield gas to protect things from oxidation – and of course as leak detection tracer gas.

Helium is a 100 % green gas and has absolutely no environmental impact on the atmosphere.

About Helium and hydrogen

Helium and leak detection: which purity ?

Helium is available in many different purity levels, the highest level of purity is requested from some laboratories for fundamental activities or very accurate analyses.

The use of the Helium as a tracer gas into a mass spectrometer doesn't require such attention. A purity in the range of 97 % to 99 % is enough .

There is absolutely no risk of accuracy lost or contamination for the cell analyzer by using standard purity level of Helium gas.

Hydrogen

Hydrogen (H₂) is the lightest element, has a gaseous specific gravity of 0.0695 and a boiling point of -423 °F (-252.8 °C) at atmospheric pressure. It is a colorless, odorless, tasteless, flammable gas found at concentrations of about 0.0001 % in air. Hydrogen is produced by several methods, including steam/methane reforming, dissociation of ammonia, and recovery from by-product streams from chemical manufacturing and petroleum reforming. Hydrogen can be stored and transported as a gas or a cryogenic liquid.

Hydrogen is flammable in the concentration range 4 % to 75 % in air or oxygen and can detonate in the range 18 % to 60 % in air or oxygen .

A 500

Operator interface: control panel

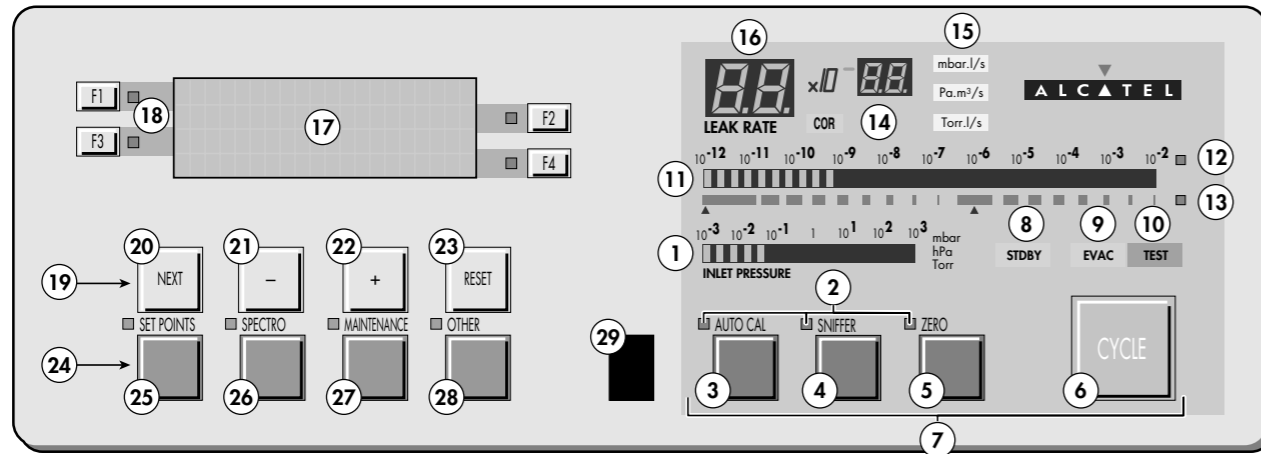

- 1 Inlet port pressure analog display
- 2 Control and menu selection indicators (ON when activated)
- 3 Auto-calibration START/ABORT control key
- 4 Sniffing mode ON/OFF control key
- 5 Auto-zero ON/OFF control key
- 6 Cycle START/STOP control key
- 7 Control keys (4 keys)
- 8 Standby ON/OFF indicator
- 9 Evacuation ON/OFF indicator
- 10 Test ON/OFF indicator
- 11 Helium signal analogic display
- 12 Helium signal analogic scale ON/OFF indicator
- 13 Helium signal Zero scale ON/OFF indicator
- 14 Correction factor COR indicator (applied to digital display)
- 15 Units ON/OFF indicator
- 16 Helium signal digital display
- 17 Alphanumeric display (4 lines x 20 characters)
- 18 Parameter function keys (1 key per display line)
- 19 Modification access keys (4 keys)
- 20 NEXT : next display/parameter circular function
- 21/22 Plus or minus value adjustment, parameter selection, audio volume adjustment keys
- 23 RESET of previously displayed values (cancels temporary inputs)
- 24 Menu selection access keys (4 keys)
- 25 SET POINT menu selection key
- 26 SPECTRO calibration and analyzer cell configuration menu selection key
- 27 MAINTENANCE menu selection key
- 28 OTHER menus selection key (test mode selection, inlet VENT selection, date/time)
- 29 Remote control connection

Operation part

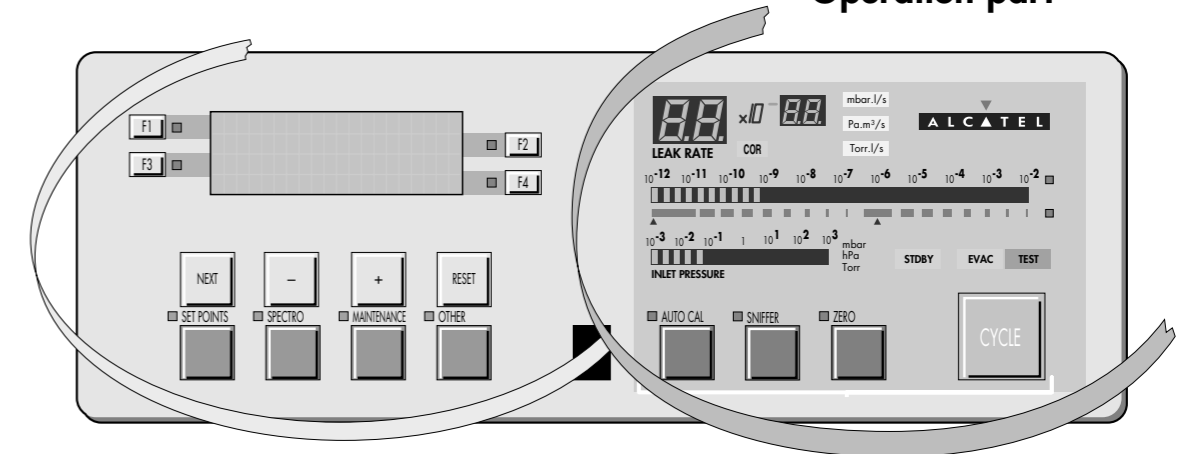

Setting and maintenance part (*)

* Operator access to setting and maintenance part depends on the user interface level.
User interface level C 120

Parameter function keys (1 key per display line)

Helium signal display

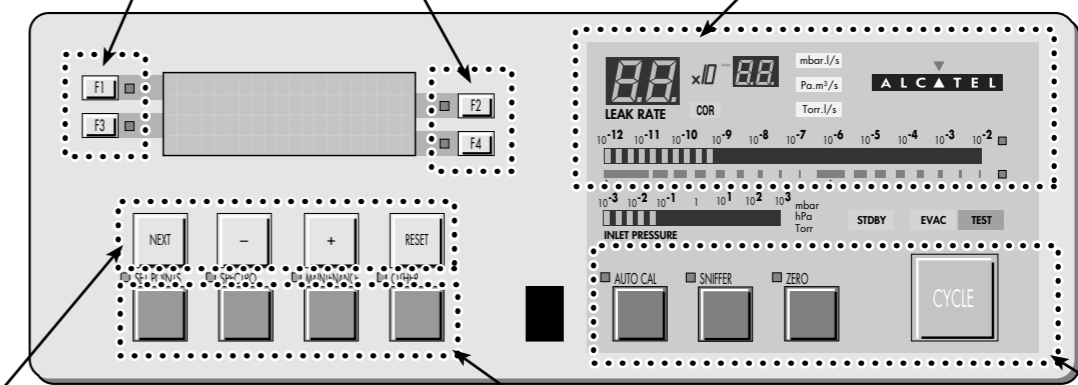

Modification access keys (4 keys)

Menu selection access keys (4 keys)

Control keys (4 keys) and control and menu selection indicators (ON when activated)

Remote control interface C 400

Control panel with graphic interface (option) C 440

A 500

Operator interface: control panel

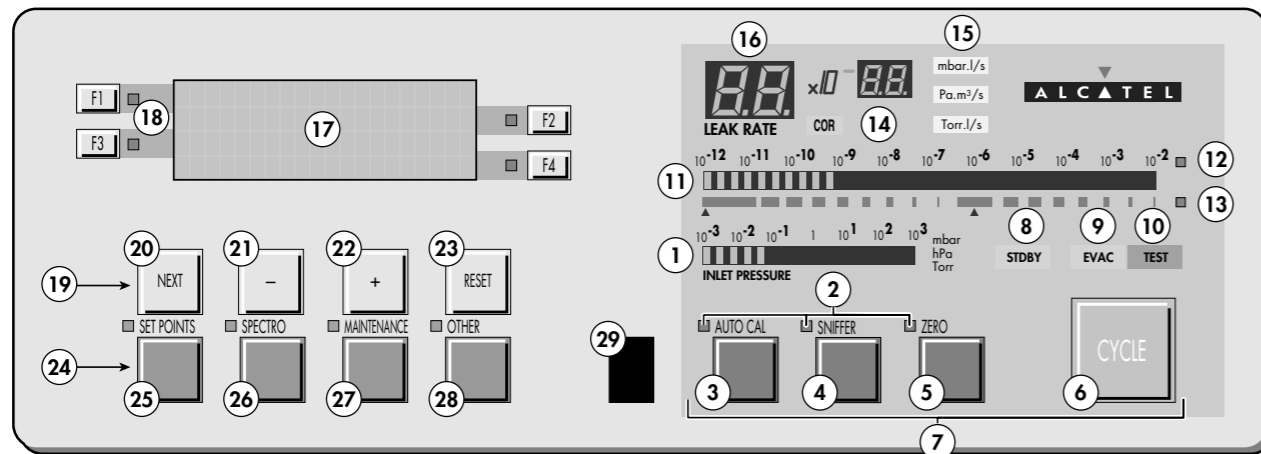

- 1 Inlet port pressure analog display
- 2 Control and menu selection indicators (ON when activated)
- 3 Auto-calibration START/ABORT control key
- 4 Sniffing mode ON/OFF control key
- 5 Auto-zero ON/OFF control key
- 6 Cycle START/STOP control key
- 7 Control keys (4 keys)
- 8 Standby ON/OFF indicator
- 9 Evacuation ON/OFF indicator
- 10 Test ON/OFF indicator
- 11 Helium signal analogic display
- 12 Helium signal analogic scale ON/OFF indicator
- 13 Helium signal Zero scale ON/OFF indicator
- 14 Correction factor COR indicator (applied to digital display)
- 15 Units ON/OFF indicator
- 16 Helium signal digital display
- 17 Alphanumeric display (4 lines x 20 characters)
- 18 Parameter function keys (1 key per display line)
- 19 Modification access keys (4 keys)
- 20 NEXT : next display/parameter circular function
- 21/22 Plus or minus value adjustment, parameter selection, audio volume adjustment keys
- 23 RESET of previously displayed values (cancels temporary inputs)
- 24 Menu selection access keys (4 keys)
- 25 SET POINT menu selection key
- 26 SPECTRO calibration and analyzer cell configuration menu selection key
- 27 MAINTENANCE menu selection key
- 28 OTHER menus selection key (test mode selection, inlet VENT selection, date/time)
- 29 Remote control connection

Operation part

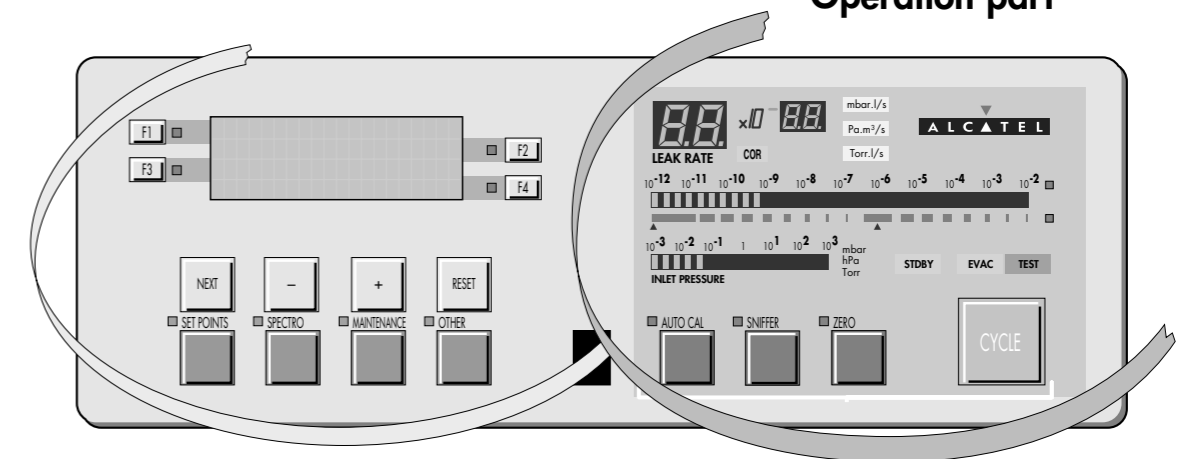

Setting and maintenance part (*)

* Operator access to setting and maintenance part depends on the user interface level. **User interface level C 120**

Parameter function keys (1 key per display line)

Helium signal display

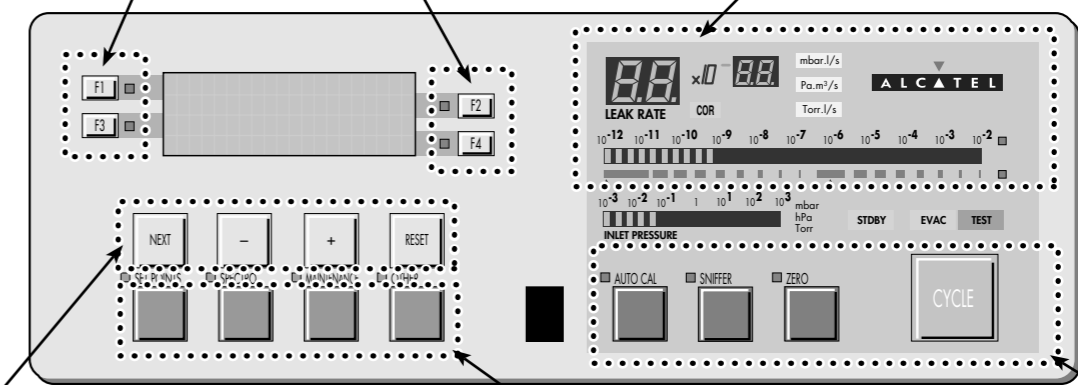

Modification access keys (4 keys)

Menu selection access keys (4 keys)



Control keys (4 keys) and control and menu selection indicators (ON when activated)

Remote control interface C 400

Control panel with graphic interface (option) C 440

Options

Which options for which model?

		ASM 102 S	ASM 122 D	ASM 142	ASM 142 S	ASM 142 D	ASM Graph D+	ASM 182 T	ASM 192 T	ASM 192 T2	ASM 182 TD+	ASM 192 TD+	ASM 192 T2D+	ASM 1002	ASI 22
Metal seals	1		•	•		•	•	•	•	•	•	•	•	•	
Inlet port	2		•											•	
Units	3	•	•	•	•	•	•	•	•	•	•	•	•	•	
Languages	4	•	•	•	•	•	•	•	•	•	•	•	•	•	
3 masses	5	•	•	•		•	•	•	•	•	•	•	•	•	
Automatic test chambers	6			•				•	•	•	•	•	•	•	
Roughing system	7								•	•		•	•		
Interface board*	8			•	•	•	•								
Remote control cable length	9	•													
Test of gas line	10										•				
Stainless steel cover (UCT)	11										•				
Control panel with graphic interface*	12			•		•	•	•			•				
Control panel racks	13														•
Sniffing*	14														•
Cables lengths	15														•
Transport cart*	 A 700										•				
Voltage configuration	-	•	•	•	•	•	•	•	•	•	•	•	•	•	
Power plug	-	•	•	•	•	•	•	•	•	•	•	•	•	•	
Standard remote control*	 A 700		•						•	•		•	•	•	

*also available in accessories

Options

Metal seals

1

Inlet and high vacuum manifolds and the analyzer cell are equipped with metal seals instead of elastomer seals to protect the leak detector against contamination with helium. This option is particularly useful in case of high sensitivity helium leak detection in an "helium contaminated environment".

Localisation of the metal seals  F 800

Inlet port

2

ASM 122 D: The standard DN 25 inlet port can be replaced by a DN 40 inlet port for convenience.

ASM 1002: The test chamber can be replaced by a DN 25 inlet port for convenience.

Units

3

The user can choose the unit of the software: mbar.l/s, Pa.m³/s or Torr.l/s.

Languages

4

The user can choose the language of the software: English, French, German or Japanese.

Note: ASM 142 S: English/French/German/Spanish.
ASM 1002: English/French.

3 masses

5

For use of one of the 3 following tracer gases:
Helium 4, Helium 3 or Hydrogen 2.

Automatic test chambers

6

This is used for the automatic bombing testing of small components. When the chamber cover is closed, the test cycle is initiated, via a contact.

3 aluminium alloy models are available:

- a hemispheric chamber, Ø 72 mm, depth 31 mm (small model),
- a cylindrical chamber, maximum Ø 85 mm and maximum depth 68 mm (medium model),
- a cylindrical chamber, maximum Ø 160 mm and maximum depth 200 mm (large model).

Note: ASM 142: large model not available.

Options

Roughing system

7

In order to reduce the roughing time when testing large volumes, a second roughing pump can be added to the roughing system:

- ASM 192 T / 192 T2 total capacity: 40 m³/h or 24 cfm.
- ASM 192 TD+ / 192 T2D+ total capacity: 50 m³/h or 36 cfm.

Apart from the roughing capacity, the weight and the power consumption, the characteristics and the use of the leak detector remain the same.

Interface board

8

The helium leak detector can be equipped with a software version which will offer a complete RS 232 protocol:

- 3 operating modes: basic, advanced, printer;
- possibility to remote control the detector (start/stop, autozero, auto-cal etc...);
- possibility to obtain and adjust the settings;
- possibility to obtain all the maintenance information for preventive maintenance purposes.

This RS 232 is the most effective interface to supervise your leak test from a PC (data recording on an Excel sheet, for instance) and/or to monitor the detector from a small PLC.

Remote control cable length

9

3 lengths are proposed: 5 m (16 Ft), 10 m (32 Ft) and 15 m (49 Ft).

Test of gas line

10

Used to perform spray testing on long lines (typical diameter 1/4"), with a reduced response time due to the transfer of the helium by a carrier gas injected in viscous flow.

In this case, the detector is equipped with an additional 1/4" VCR connector specific to this option.

Stainless steel cover (UCT)

11

Designed for use of the unit in clean rooms ("Ultra Clean Technology").

The front and rear covers and frame are made of stainless steel.

Options

Control panel with graphic interface

12

The control panel with graphic interface is equipped with a color touch screen. It allows it to have, as a supplement to the standard control panel functions, a graphic interface.

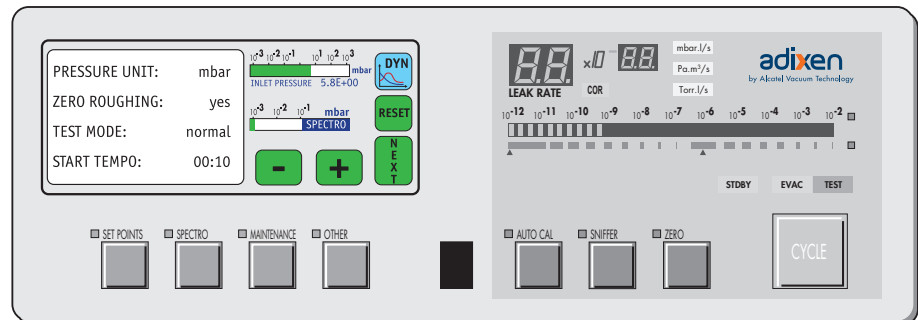

Control panel racks

13

The leak detector is delivered with 5 m (16 Ft) or 10 m (32 Ft) cables.

Standard

The standard control panel rack allows to manage the detector: setting, test, calibration, ...

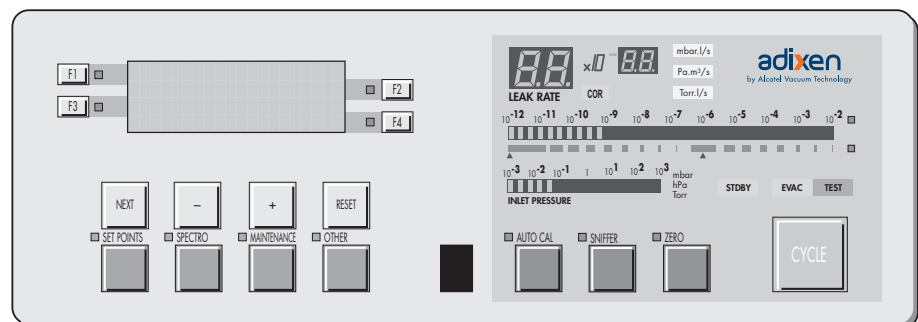

Touchscreen

The control panel with graphic interface is equipped with a color touch screen. It allows it to have, as a supplement to the standard control panel functions, a graphic interface.

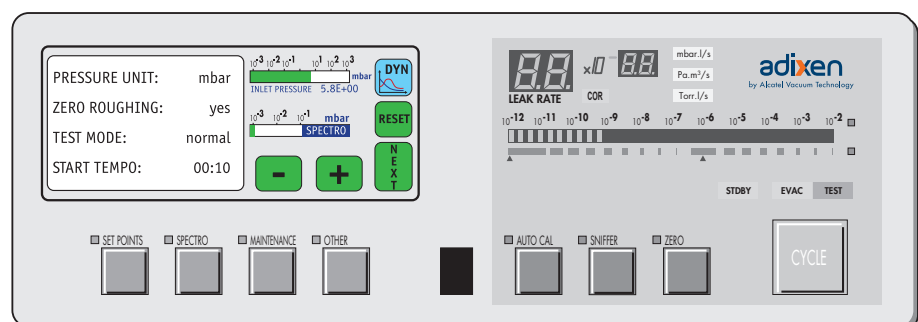

Options

Sniffing

14

This option allows to work in sniffing mode.

The ASI 22 can be fitted with a long distance sniffer probe kit composed of the following:

- a sniffing probe (to order separately  **A 700**)
- a sniffing cell,
- 2 male and female connectors,
- the connecting accessories and the hose.

(Installation  **B 250**)



Câbles lengths

15

2 cables lengths connecting the electronic module and the detection module are proposed: 2 m (6 ft) ou 5 m (16 ft).

Accessories



Which accessories for which model?

		ASM 102 S	ASM 122 D	ASM 142	ASM 142 S	ASM 142 D	ASM Graph D+	ASM 182 T	ASM 192 T	ASM 192 T2	ASM 182 TD+	ASM 192 TD+	ASM 192 T2D+	ASM 1002	ASI 22
Standard remote control and cable*	1	•	•	•	•	•	•	•	•	•	•	•	•	•	•
Long distance sniffer (LDS) probe	2	•	•	•	•	•	•	•	•	•	•	•	•	•	•
10 m/30 feet LDS extension	3	•	•	•	•	•	•	•	•	•	•	•	•	•	•
Headphone connector (required interface board)	4			•	•	•	•	•	•	•	•	•	•	•	•
Transport cart*	5			•	•	•		•			•				
Foot pedal for cycle command (1.5 m/ 5 feet)	6							•	•	•	•	•	•	•	
Calibrated helium leaks	7	•	•	•		•	•	•	•	•	•	•	•	•	•
Calibration accessory	8	•	•	•	•	•	•	•	•	•	•	•	•	•	•
Spray probe	9	•	•	•	•	•	•	•	•	•	•	•	•	•	•
Interface board* (p/n 107657)	 A 600			•	•	•	•								
Inlet adaptor	10													•	
Printer	11														
Inlet filter	12		•	•		•	•	•	•	•	•	•	•	•	
Short distance sniffer probe	13		•	•		•	•	•			•	•		•	
Bombing chamber	14		•	•		•	•	•	•	•	•	•	•	•	
Test chambers	15		•	•		•	•	•	•	•	•	•	•	•	
Neutral gas vent line kit	16			•											
4 swiveling wheels kit	17								•	•		•	•		
Covered sniffer probe and remote control kit	18				•										
Bottle handle for cart	19										•				
Fitted mini-printer	20														•

*also available in options

Accessories

Which accessories for which model?

		ASM 102 S	ASM 122 D	ASM 142	ASM 142 S	ASM 142 D	ASM Graph D+	ASM 182 T	ASM 192 T	ASM 192 T2	ASM 182 TD+	ASM 192 TD+	ASM 192 T2D+	ASM 1002	ASI 22	
2005 IS pump	21															•
Pressure measurement kit	22															•
Ventilation kit	23						•									•
Control panel with graphic interface* (p/n: 111716)	 A 600			•		•		•			•					
Control panel rack * <ul style="list-style-type: none"> ■ Standard - 5 m (15 feet) cable: p/n 113134 ■ Standard - 10 m (32 feet) cable: p/n 112775 ■ Touchscreen - 5 m (15 feet) cable: p/n 113133 ■ Touchscreen - 10 m (32 feet) cable: p/n 112776 	 A 600															•
Long distance sniffer kit * (p/n: 104757)	 A 600															•
Boottle handfe for cart	24						•									
Remote control holder	25						•									

*Also available in option

Accessories

Remote control



The remote control is equipped with a magnet allowing the operator to place it on a magnetized surface. The operator can read the helium signal and has access to control keys such as cycle command autocalibration and auto-zero.

2 models are available:

- 1 standard for all leak detectors except ASM 102 S / ASM 142 S:

Remote control with 5 m/15 feet cable length:

Designation	Part No
Unit: mbar.l/s - Front face in English	106 688
Unit: Torr.l/s - Front face in English	108 881
Unit: Pa.m ³ /s - Front face in English	108 880
Unit: Pa.m ³ /s - Front face in Japanese	106 690

Note: The remote control is delivered in standard with the ASM 192 series and ASM 122 D.

English serigraphy

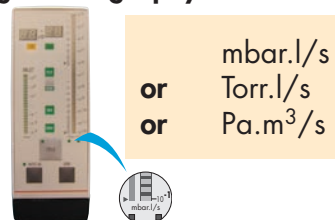

Japanese serigraphy

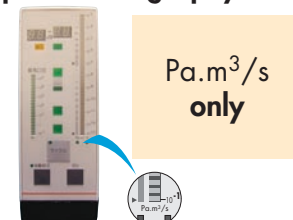

- 1 specific for sniffing leak detectors (ASM 102 S / ASM 142 S):

Remote control with 5 m/15 feet cable length:

Designation	Part No
Unit: mbar.l/s - Front face in English	112 747



Cable for remote control (remote control not provided):

Designation	Part No
Cable of 10 m/394"	110 881
Cable of 15 m/591"	110 882
Cable of 20 m/787"	802 494
Cable of 25 m/984"	802 339
Cable of 30 m/1181"	802 767
Cable of 35 m/1377"	802 768
Cable of 40 m/1575"	802 769
Cable of 45 m/1771"	802 770
Cable of 50 m/1969"	802 771



Only Cable

Accessories

Long Distance Sniffer probe

2

Sniffer probe with a rigid nipple Sniffer probe with a flexible nipple



LDS probe part number	5 m/15 Ft canalisation				10 m/32 Ft canalisation			
	Rigid nipple		Flexible nipple		Rigid nipple		Flexible nipple	
	9 cm	30 cm	15 cm	45 cm	9 cm	30 cm	15 cm	45 cm
	SNC1E1T1	SNC1E2T1	SNC1E3T1	SNC1E4T1	SNC2E1T1	SNC2E2T1	SNC2E3T1	SNC2E4T1



Long distance sniffer with short rigid nozzle:

Designation	Part No
Tube length 20 m/787"	802 826
Tube length 30 m/1181"	802 827
Tube length 40 m/1575"	802 828
Tube length 50 m/1969"	802 829
Tube length 60 m/2362"	802 830
Tube length 70 m/2756"	802 831
Tube length 80 m/3150"	802 832
Tube length 90 m/3543"	802 833
Tube length 100 m/3937"	802 834

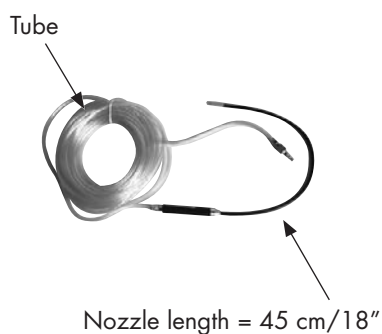

Long distance sniffer with long flexible nozzle:

Designation	Part No
Tube length 20 m/787"	802 835
Tube length 30 m/1181"	802 836
Tube length 40 m/1575"	802 837
Tube length 50 m/1969"	802 838
Tube length 60 m/2362"	802 839
Tube length 70 m/2756"	802 840
Tube length 80 m/3150"	802 841
Tube length 90 m/3543"	802 842
Tube length 100 m/3937"	802 843

Accessories

10 m/30 feet LDS extension

3

Used to extend the LDS probe by 10 m/30 feet.
Part No: **090216**



Headphone connector

4

With the headphone connector, the operator can connect a headphone to its detector.

Part No: **A459818**

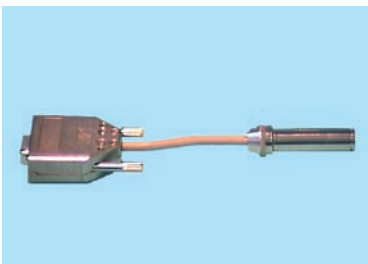

The headphone connector is an accessory but to use it, the detector must be equipped with the interface board option.

Which headphone used?  C 410

Transport cart

5

ASM 182 range
Part No: **111196**



Accessories

Transport cart (ctd)

ASM 142 range

It can be fixed to the detector.

Part No: **108068**

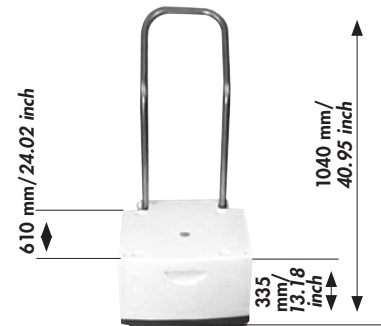

ASM 142 range

In addition to the standard cart (p/n 108068), a 4 wheels stainless steel cart is proposed for 142 series.

Part No: **802862**



Foot pedal for cycle Part No: 100913 command (1.5 m/ 5 feet)

Part No: **100913**

6



Accessories

Calibrated Helium leaks

7

There are several types of calibrated leaks, with or without reservoir, with or without valve, covering several leak ranges. The choice of the appropriate external calibrated leak depends on the application requirements. For further information on the Adixen calibrated leaks, please refer to our product catalog or consult your local A.V.T.F. sales engineer. Most of the Adixen calibrated leaks are delivered with a calibration certificate.



Helium 3 and Hydrogen calibrated leaks

Principle

The manufacturer does not supply the calibrated leaks in Helium 3 and Hydrogen.

All Adixen calibrated leaks are based on permeable membrane technology.

external calibrated leak recalibration

Most calibrated leaks last many years even though the helium is permanently escaping (the leak rate is very small in comparison to the amount of helium contained in the reservoir: yearly loss is indicated on the calibrated leak identification label).

However, it is recommended to have every calibrated leak (with reservoir) recalibrated on regular intervals to validate its value: this is applicable for both internal and external calibrated leaks.

Recalibration period of the calibrated leak depends on its leak rate value.

Recommendation for proper Quality Control:

THE RECALIBRATION INTERVALS SHOULD NOT EXCEED 2 YEARS.

Please consult your local Alcatel Sales representative for additional information.

Calibration accessory

8

Used to connect the alibrated leak and the sniffer probe for a calibration.

Model	Part No
DN 16	110715
DN 25	110716



Accessories

Spray probe

9

Helium spray probe.
Part No: **109951**

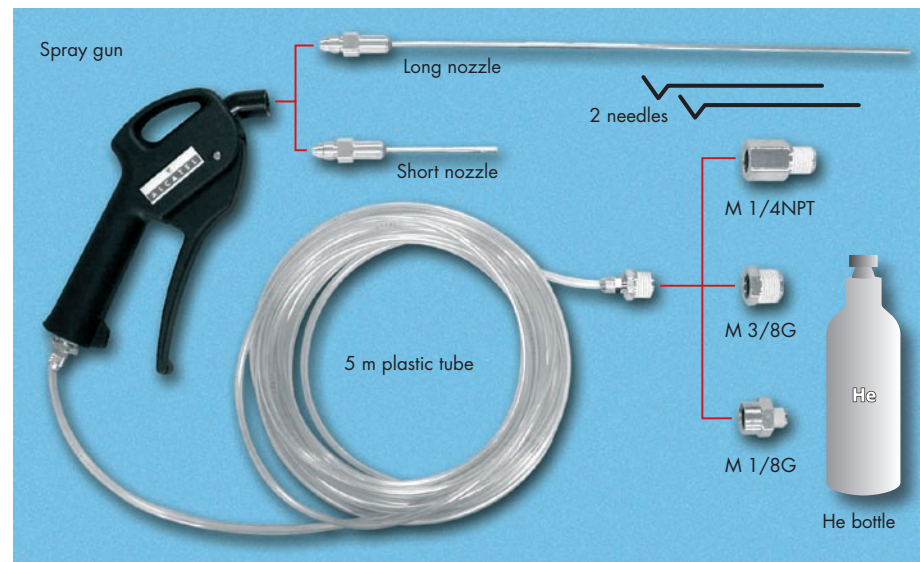

Spraying Helium in order to detect a leak is usually very easy, especially if you need fast and rough detection. Spraying Helium could also become a technical challenge when you need to pinpoint very fine leaks, more so, when they are located in areas with difficult access.

The Helium spray gun is an easy to use and multipurpose tool which allows you to work in various conditions of test:

- Multi standard: thanks to the 3 different adapters to be connected to the Helium bottle (M 1/4 NPT, M 3/8G and M 1/8G).
- Multi purpose: thanks to the 2 nozzle lengths of 80 mm / 3.14 inch and 290 mm / 14.4 inch.
- Standard leak mode: for quick and rough leak tests.
- Fine leak mode.

The Helium spray gun is provided with 2 standard needles which allow the adjustment of the Helium flow at the outlet of the nozzle.

Inlet adaptor

10

Adaptator plug is necessary to connect the calibrated leak to the inlet part (test chamber) of the detector.
Part No: **067791**

Printer

11

The manufacturer does not supply the printers. The printer should be connected to the leak detector and have the following characteristics:

- RS232 serial type
- 40 columns minimum.

Accessories

Inlet filters

12



Designation	DN Flange	Part No
70 µm stainless steel mesh filter	16	072 721
70 µm stainless steel mesh filter	25	072 857
70 µm stainless steel mesh filter	40	067 636
20 µm inlet filter	25/25	105 841
20 µm inlet filter	40/40	105 842
20 µm inlet filter	40/25	105 843
5 µm inlet filter	25/25	105 844
5 µm inlet filter	40/40	105 845
5 µm inlet filter	40/25	105 846
20 µm inlet filter	Ø 114 mm	105 847
5 µm inlet filter	Ø 114 mm	105 848
O'ring, Ø 5 mm	Ø 114 mm	082 152

Short distance sniffer probe (to be connected to the inlet part of a leak detector):

Temperature coefficient: 7 % per °Celsius.
 Standard leak rate: 2×10^{-4} mbar.l/s
 Able to measure helium concentration inside water or liquids.

13



Designation	DN Flange	Part No
Sniffer probe with membrane, DN 40 flange and a 1.5 meter tube (5 ft)	40	067 683
Sniffer probe with membrane, DN 40 flange	40	067 677
Sniffer probe with membrane, DN 25 flange	25	103 592
Sniffer probe with membrane and 14 mm O.D. smooth tube connection	Ø 14 mm	067 678

Accessories

Bombing chamber

14

Designation	DN Flange	Part No
Bombing chamber 10 bars (Ø 150 - L 200 - Vol.: 3.5 l)	-	786 396
Bombing chamber 25 bars (Ø 150 - L 200 - Vol.: 6.4 l)	-	786 397
Adaptator DN 25 to USA 1 1/8 OD tube	25	795 716
Adaptator DN 40 to USA 1 1/8 OD tube	40	067 890

Test chambers

15

- Small test chamber: hemispherical test chamber, Ø 72 mm, depth 31 mm
- Medium test chamber: cylindrical test chamber, Ø 85 mm, depth 68 mm
- Large test chamber: cylindrical test chamber, Ø 160 mm, depth 100 mm

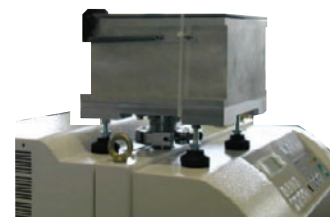

Designation	Part No
Small test chamber DN 25 (1)	802 452
Small test chamber DN 40 (2)	802 453
Small test chamber DN 50 (3)	802 454
Medium test chamber DN 25 (1)	802 455
Medium test chamber DN 40 (2))	802 456
Medium test chamber DN 50 (3)	802 457
Large test chamber DN 40 for ASM 182 T/TD+	802 458
Large test chamber DN 40 for ASM 192 T/TD+	802 459
Large test chamber DN 50 for ASM 192 T2/T2D+	802 460

- (1) ASM 142 - ASM 142 D - ASM 122 D
 (2) ASM 122 D - ASM 182 T/TD+ - ASM 192 T/TD+
 (3) ASM 192 T2/T2D+

Accessories

Neutral gas vent line kit

16

Part No: **801421**



Neutral gas vent line kit

4 swiveling wheels kit (Ø 125 mm)

17

Soft wheel: improve the mobility

Customers have the possibility to lock 1, 2, 3 or 4 wheels independently.



Part No: **801846**

Accessories

Covered sniffer probe and remote control kit

18

Length = 5 m/197"

Remote control:
mbar.l/s - English



Long distance sniffer probe

Part No: **802844**

Bottle handle for cart

19

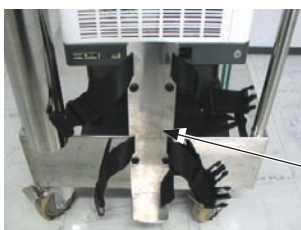

Bottle handle for cart p/n 111196
Part No: **802819**

Accessories

Built-in mini-printer

20

Part No: **100728**

■ The mini-printer can print out test result tickets or a record of all the important events involving the detector:

- calibration,
- faults,
- changes in settings,
- etc.

■ Connection  **B 250**

■ Maintenance kit: **P/N 100807** (5 rolls of paper + 2 ribbons)

■ Paper characteristics:

Grade A. wood free 57 x 50mm, 12 mm diameter, color: white
Ink: ERC - 09 or ERC - 22 for EPSON

2005 IS Pump

21

■ Characteristics:

- 2 stages pump
- flow rate: 4 m³/h
- connector for LDS
- voltages should be specified when ordering
- supplied without connecting accessories.
- accessories for primary pump:
 - filter OME 25 S - **P/N 104200**
 - filter cartridge - **P/N 068304**

■ Part No to command:

205 SIM X X M

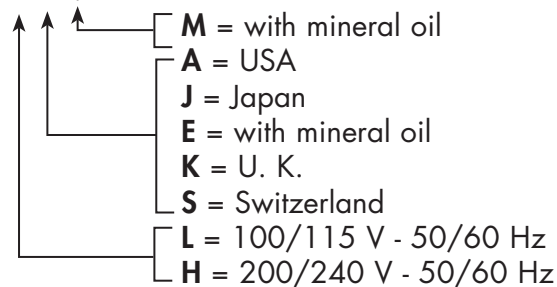

Accessories

Pressure measurement kit

Part No: **104761**

The ASI 22 can be fitted with a pressure measurement kit.

22

It is composed of the following:

- a stainless steel PI3C gauge,
- a gauge-unit connection cable, l.: 5 meters/197".

Installation:  **B 250**

Ventilation Kit

Part No: **104762**

The ASI 22 can be fitted with a detection module ventilation kit. It is composed of the following:

23

- a fan and its support,
- a connection cable.

The long distance sniffer probe should be ordered separately.

Installation:  **B 250**

Bottle handle for cart

24



Part No: **112 532** (Ø 135-145)

112 533 (Ø 177)

ASM 142

Technical characteristics

	Measurement range (Helium)		Crossover pressure (at inlet)	
	mbar.l/s	Pa.m ³ /s	mbar	Pa
Gross leak test mode	1x10 ⁻⁹ to 1	1x10 ⁻¹⁰ to 0.1	10	1000
Normal test mode	1x10 ⁻¹¹ to 3x10 ⁻⁴	1x10 ⁻¹² to 3x10 ⁻⁵	5x10 ⁻¹	50
Sniffing test mode	1x10 ⁻⁷ to 1x10 ⁻¹	1x10 ⁻⁸ to 1	sniffer probe at atm. pressure	
Response time (Inlet port blanked off)				< 0.5 s

Helium pumping speed at inlet port:

Gross leak test mode (at minimum inlet pressure)	1.1 l/s
Normal test mode (at minimum inlet pressure)	1.3 l/s

Roughing pump characteristics:

Roughing pump pumping speed (in air)	10 m ³ /h
--------------------------------------	----------------------

Analyzer cell (Spectro):

Analyzer cell design	self protected 180° magnetic deflection mass spectrometer
Analyzer cell filament	2 separate tungsten filaments
Analyzer cell sensitivity	3x10 ⁻⁴ A/mbar
Emission current range	0.2 to 2 mA

Displays adjustments:

Inlet port pressure display range	10 ³ to 10 ⁻³ mbar
	10 ⁵ to 10 ⁻¹ Pa

ASM 142 Technical characteristics

Audio alarm: 90 dB frequency modulated and adjustable audio signal

Hard vacuum Audio signal set point	Adjustable throughout the entire measuring range
Sniffing Audio set point	Adjustable throughout the entire measuring range

Start-up time (average, at 20 °C):

Without autocalibration	1 min 3 s ± 10 %
With autocalibration	2 min 15 s ± 10 %

Time to reach test mode (Hard vacuum test):

	inlet port blanked-off	connected to 1.6 liter volume	connected to 12.5 liter volume
--	---------------------------	----------------------------------	-----------------------------------

Gross leak test mode	1.8 s	4 s	30 s
Normal test mode	2.3 s	8 s	1 min 03 s

Miscellaneous:

Power voltage	low voltage :	100 - 130 V ± 10%
	high voltage :	200 - 240 V ± 10%
Power frequency		50/60 Hz single phase
Power consumption (maximum)		< 1kW
Start-up temperature		10 to 45° C
Ambient operating temperature		0 to 45° C
Storage temperature		-25° C to 70° C
Storage temperature (detector equipped with the graphic interface control panel)		-20° C to 60° C max. 48 h at -20° C max. 168 h at 60° C
Humidity (detector equipped with the graphic interface control panel)	Ta ≤ 40° C	Ta > 40° C
	85 % relative humidity max.	Absolute humidity must be lower than the humidity of 85 % relative humidity at 40° C (43.4 g/m ³ in the air)
Noise level (at 1 meter; audio alarm not operational, stand by mode)		57 dBA
House protection level		20C IP
Weight		56 kg /123 lb
Inlet		DN 25

ASM 142 D - ASM Graph D+ Technical characteristics

	Measurement range (Helium)		Crossover pressure (at inlet)	
	mbar.l/s	Pa.m ³ /s	mbar	Pa
Gross leak test mode	1x10 ⁻⁹ to 1	1x10 ⁻¹⁰ to 0.1	10	1000
Normal test mode	1x10 ⁻¹¹ to 3x10 ⁻⁴	1x10 ⁻¹² to 3x10 ⁻⁵	5x10 ⁻¹	50
Sniffing test mode	1x10 ⁻⁷ to 1x10 ⁻¹	1x10 ⁻⁶ to 1	sniffer probe at atm. pressure	
Response time (Inlet port blanked off)				< 0.5 s

Helium pumping speed at inlet port:

Gross leak test mode (at minimum inlet pressure)	1.1 l/s
Normal test mode (at minimum inlet pressure)	1.3 l/s

Roughing pump characteristics:

Roughing pump pumping speed (in air) (ASM 142 D)	1 m ³ /h
Roughing pump pumping speed (in air) (ASM Graph D+)	14 m ³ /h

Analyzer cell (Spectro):

Analyzer cell design	self protected 180° magnetic deflection mass spectrometer
Analyzer cell filament	2 separate tungsten filaments
Analyzer cell sensitivity	3x10 ⁻⁴ A/mbar
Emission current range	0.2 to 2 mA

Displays adjustments:

Inlet port pressure display range	10 ³ to 10 ⁻³ mbar
	10 ⁵ to 10 ⁻¹ Pa

Audio alarm:

90 dB frequency modulated and adjustable audio signal

Hard vacuum Audio signal set point	Adjustable throughout the entire measuring range
Sniffing Audio set point	Adjustable throughout the entire measuring range

Start-up time (average, at 20° C) (ASM 142 D):

Without autocalibration	1 min 22 s ± 10 %
With autocalibration	3 min 5 s ± 10 %

Start-up time (average, at 20° C) (ASM Graph D+):

Without autocalibration	1 min 15 s ± 10 %
With autocalibration	3 min ± 10 %

ASM 142 D - ASM Graph D+ Technical characteristics

Time to reach test mode (Hard vacuum test) (ASM 142 D):	inlet port blanked-off	connected to 1.6 liter volume	connected to 12.5 liter volume
Gross leak test mode	3.5 s	21 s	2 min 15 s
Normal test mode	5 s	24 s	2 min 37 s

Time to reach test mode (Hard vacuum test) (ASM 142 Graph +):	inlet port blanked-off	connected to 1.6 liter volume	connected to 12.5 liter volume
Gross leak test mode	3.5 s	7 s	45 s
Normal test mode	5 s	11 s	1 min 11 s

Miscellaneous:

Power voltage	low voltage :	100 - 130 V \pm 10%
	high voltage :	200 - 240 V \pm 10%
Power frequency	50/60 Hz simple phase	
Power consumption (maximum)	< 500 W	
Start-up temperature	10 to 35° C	
Ambient operating temperature	0 to 35° C	
Storage temperature	-25° C to 70° C	
Storage temperature (detector equipped with the graphic interface control panel)	-20° C to 60° C max. 48 h at -20° C max. 168 h at 60° C	
Humidity (detector equipped with the graphic interface control panel)	Ta \leq 40° C	Ta > 40° C
	85 % relative humidity max.	Absolute humidity must be lower than the humidity of 85 % relative humidity at 40° C (43.4 g/m ³ in the air)
Noise level (at 1 meter; audio alarm not operational, stand by mode) (ASM 142 D)	50 dBA	
Noise level (at 1 meter; audio alarm not operational, stand by mode) (ASM Graph D+)	60 dBA	
House protection level	20C IP	
Weight (ASM 142 D)	42 kg/92 lb	
Weight (ASM Graph D+)	71 kg/156 lb	
Inlet	DN 25	

A 900

Dimensions (mm/inch)

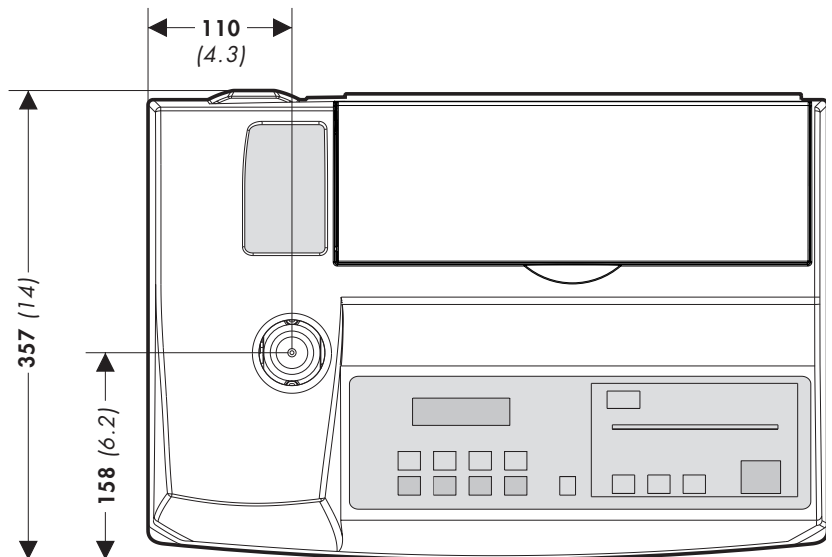
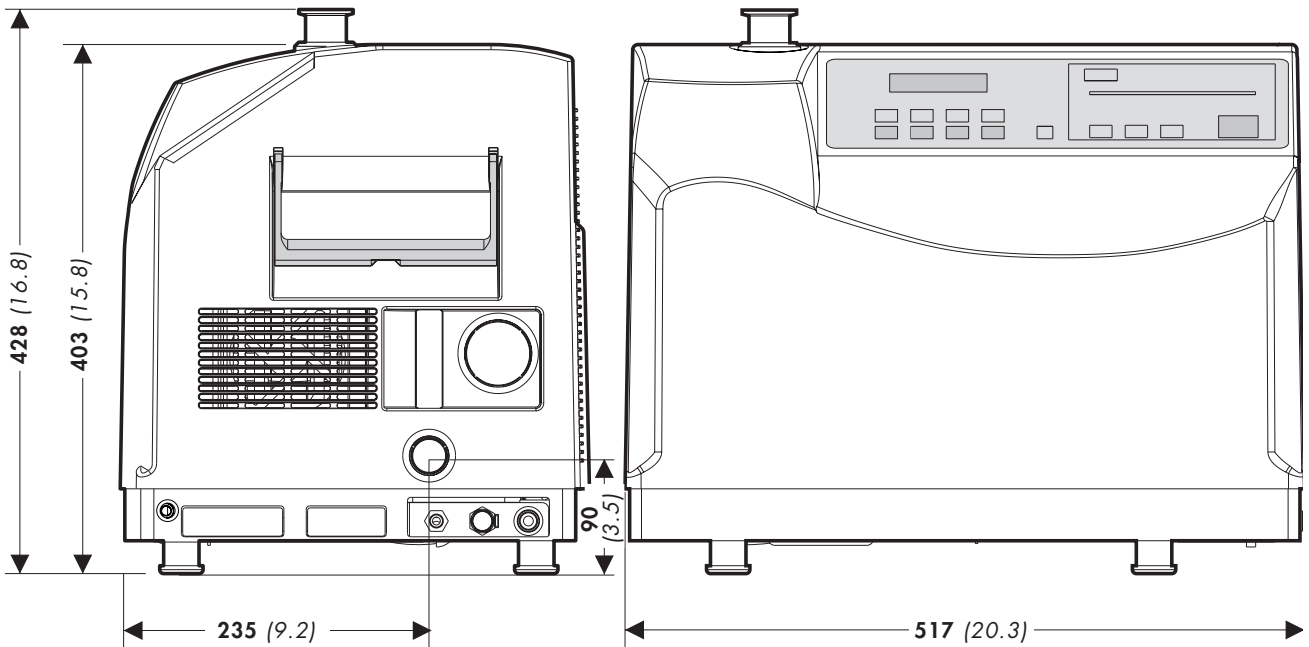

Dimensions (mm/inch) ASM Graph D+

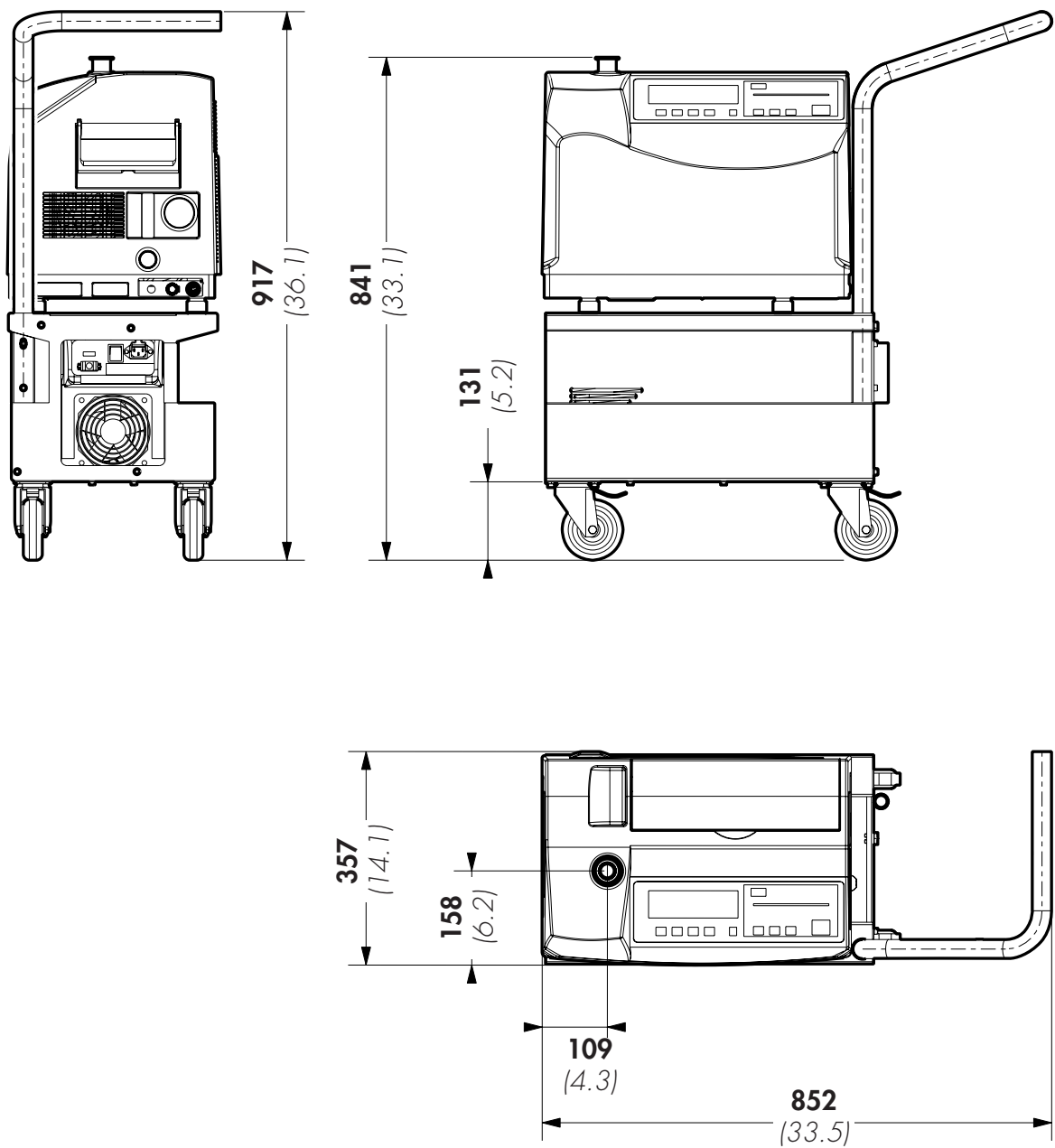



Detailed contents

Preliminary remarks Throughout this User's Manual, you could find this type of message "Summary of screen  C 140": it refers to a specific chapter of the User's Manual. Please read it for further information.

B 100

Safety instructions

- Generalities
- Pump labels
- Leak detector labels
- Alcatel contact in case of emergency

B 110

Unpacking - Storage - Transportation

- Unpacking
- Supplies
- Storage
- Fixed mounting
- Transport

B 200

Neutral gas purge and inlet vent connection

- Products concerned
- Connection to the leak detector
- Use
- Gas characteristics

B 201

Neutral gas purge installation (accessory)

- Purpose
- Material
- Installation

B 210

Connecting the detector to the installation

B 211

Connecting the detector to the installation: ASM graph D+

B 300

Controlling the detector with the I/O interface

- Purpose of the I/O interface
- Location of the I/O interface
- Prepare the connector wiring
- The controls (inputs)
- The signals (outputs)
- 24 V DC Power supply



ASM 142 - ASM 142 D ASM GRAPH - ASM GRAPH D ASM GRAPH D+

User's Manual

Detailed contents

B 310

Controlling the detector with a PC computer through the RS 232 interface

- Purpose of the PC computer interface
- Location of the RS 232 interface
- RS 232 interface instructions
- Commands available for your leak detector

B 320

Connecting the detector directly to a printer or another device

- Purpose of the printer interface
- Location of the printer interface
- Connector description
- Communication mode description
- Connection to the printer
- Tickets available

B 400

Before starting up the leak detector

- Check power voltage
- Check the oil level of the rotary vane pump

Safety instructions



Indicates a potentially hazardous situation which, if not avoided, could result in property damage.



CAUTION

Indicates a potentially hazardous situation which, if not avoided, could result in moderate or minor injury. It may also be used to alert against unsafe practices.



WARNING

Indicates a potentially hazardous situation which, if not avoided, could result in death or severe injury.



WARNING

Indicates an imminently hazardous situation that, if not avoided, will result in death or severe injury (extreme situations).

Generalities

- Our products are designed to comply with current EEC regulations. Any modification of the product made by the user is liable to lead non-compliance with the regulations, or even to put into doubt the EMC (ElectroMagnetic Compatibility) performance and safety of the product. The manufacturer declines any responsibility for such operations.

- The EMC performance of the product is obtained on the condition that the installation complies with the EMC rules. In particular, in disturbed environments, it is essential to:
 - use shielded cables and connections for interfaces,
 - stabilize the power supply line with meshing from the power supply source to a distance of 3 m from the product inlet.

Before switching on the pump, the user should study the manual and follow the safety instructions listed in this conformity declaration booklet delivered with the product.

- The leak detectors must be connected to an electrical installation in compliance with decree 88-1056 of 14 th November 1988.



CAUTION

Risk of toppling: although the products comply with ECC regulations, it is important to take precautions to avoid toppling during handling, installation and operation.

Safety instructions



Certain detectors are fitted with oil pumps: the oil load needed for pump operation is in separate cans. We also recommend that the user drains the pump before re-shipping the equipment.



When relevant, remove the protection which blocks the outlet of the pump, on the rear of the leak detector. We recommend connecting this outlet to a gas evacuation circuit for the oil seal pump. This circuit should have as little excess pressure as possible (less than 0.3 bar).



Storage of the equipment: our equipment can be stored without special precautions for up to 3 months (room temperature between 5°C and 40°C). For longer periods, factors such as humidity content, temperature, salty atmosphere, etc., can cause damage to certain «sensitive» parts (elastomer seals, lubricant, etc.).



Check the pumping conditions of the detector: the leak detectors are not equipped for pre-pumping of corrosive gases, condensable vapours of liquids, even in small quantities.



The manufacturer can not take any responsibility or apply any warranty on a leak detector which is used with a presence of corrosive or dangerous gases: all our leak detectors are not designed to pump dangerous substances.



A helium leak detection operation must be made in a safe environment for the user and the equipment: all precautions must be taken by the user of the leak detector in that respect (especially to eliminate the presence of chemicaly, aggressive, toxic or hazardous substance prior to the test operation). The manufacturer has no control over the types of gases passing through the pumps.



Ensure that parts or enclosures connected to the inlet of the detectors can handle a pressure drop of 1 bar relative to atmospheric pressure.



If the detector rotates in an axis perpendicular to the axis of rotation of the secondary pump, there is a risk of seizure of the secondary pump.

Safety instructions



When the device is switched off, avoid touching the pins of the mains plug. Residual voltages due to filter capacitors can provoke an electrical shock.



When the main electrical switch on the detector is set to «0», the part supply between the power plug and the main switch remains energized.
Risk of electrical shock in case of contact.
Disconnect main electrical cable before servicing.



Hazardous voltage enclosed.
Voltage or current hazard sufficient to cause shock.
Disconnect and lockout power before servicing.
Any intervention must be done by trained personnel only.



When the leak detector is switched off, internal parts (monitoring, frequency converter) contain capacitors charged with over 60 VDC and remain energized.
Electrical shock may result in severe injury.
Wait 5 minutes after switching off before opening the leak detector.



Other located hazardous energies: Nitrogen purge, pressurized hazardous energies. Release pressure before servicing, disconnect the gas line quick connector and turn off the pressure regulator by turning the knob counter-clockwise.



WARNING
HOT SURFACE
Contact may cause burn.
Do not touch or wear protective gear before servicing.

Operating conditions may generate temperatures justifying particular attention on the part of the user (external surfaces > 70°C on exhaust connections).
Contact may cause burns.
Always use gloves before servicing.

Safety instructions

Pump labels



Located on the rear of the pump, this label warns the user against possible risk of injury due to any hand contact with hot surfaces. It states that protective gloves should be used before performing any intervention.

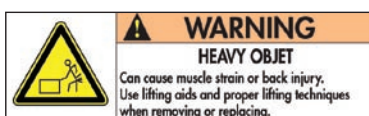

Located on the upper cover, this label indicates that due to its heavy weight, the product should not be handled manually, but always through appropriate handling devices.

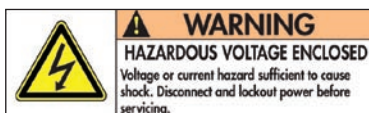

Located on the upper cover, this label indicates that some of the internal parts are energized and could cause electrical shocks in case of contact. It advises to disconnect the pump before any intervention or to properly lock-out and tag-out the equipment breaker before any intervention on the pump.

Leak detector labels

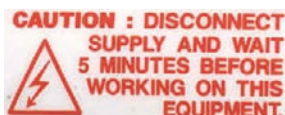

Located near the main power switch, this label indicates that after disconnecting power supply, the operator should wait 5 minutes before working on the leak detector.

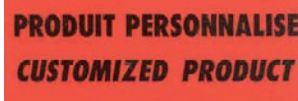

Located near the main power switch, this label indicates that the product has been customized in factory, according to customer order.



Located at the top of the frame, near the exhaust port, this label indicates that the exhaust port should not be blocked.

Safety instructions

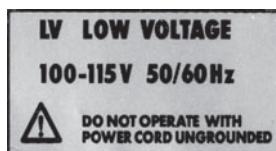

Located near the main power switch, these labels indicate the leak detector power voltage.

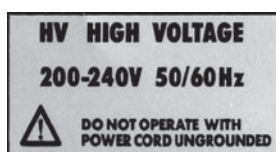

DISCONNECT BEFORE MAINTENANCE
DEBRANCHER AVANT ENTRETIEN

Located near the main power switch, this label indicates that the main power cable should be disconnected before maintenance.



This label indicates that the leak detector is conformed to the R.O.H.S. directives.



Located near the main power switch, this label indicates the part number of the leak detector and its serial number.



Recto

Located on the cover, this label indicates that the product has been drained before leaving factory. It should be fill with oil before running.



Verso

Safety instructions

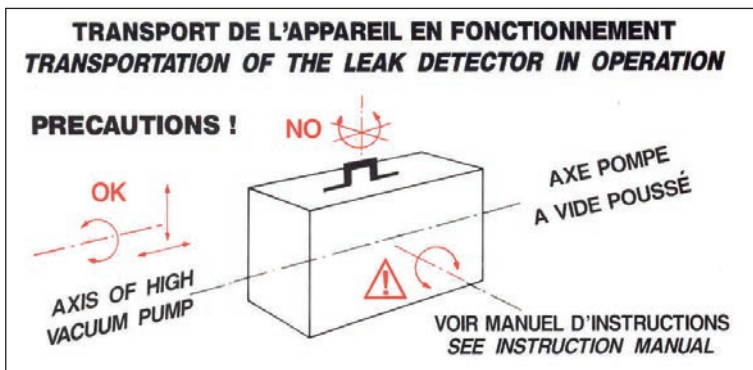

Located at the upper cover, this label indicates that the leak detector could not be moved in all positions.

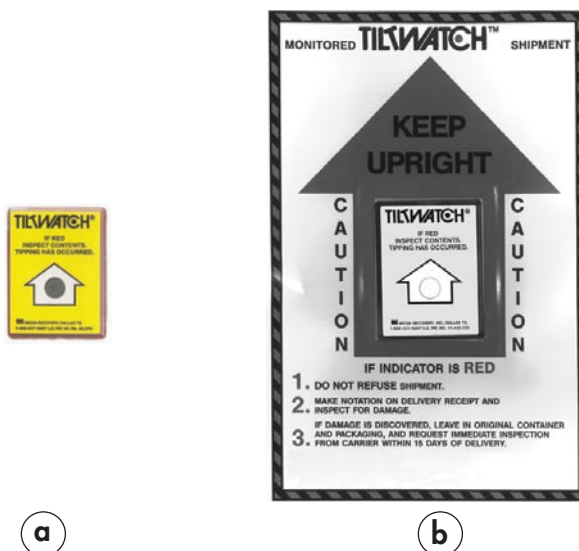

Located inside (a) or outside (b) the packaging box, this tilt indicator indicates that the box has been tipped.

Contact the manufacturer in case of emergency

In case of emergency or equipment failure, please contact your service manager of your local service center (see addresses at the back of the manual).

Unpacking - Storage - Transportation

Unpacking

When the equipment is received, unpack it carefully.

Keep the packaging box for possible return.

Check **the packaging tilt indicator** of the detector.

Before opening, check the **name of the model** and **the serial number**.



Precautionary measures for the leak detector transportation

ASM 142 -
ASM 142 S -
ASM 142 D

Use an hoist equipped with slings attached to the leak detector handles to extract it from its packaging.

Note:

If the operator doesn't use an hoist, 2 people are necessary to extract and carry the leak detector.

Weight:  **A 800**

Notch for handling hook

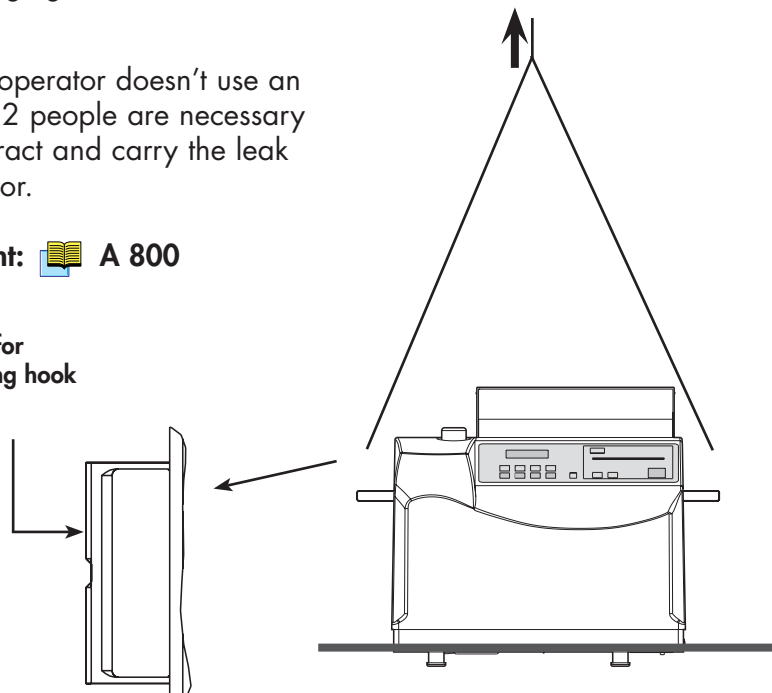

In the event of an anomaly, take the necessary action with the shipper and notify the manufacturer if necessary.

Unpacking - Storage - Transportation

ASM 142 Graph D+ To carry **ASM Graph D+**, 2 people are necessary. Not to use neither the cart handle, nor detector handles: you must imperatively raise it by lower of the cart.



Unpacking - Storage - Transportation

Supplies The following parts are supplied with your detector:

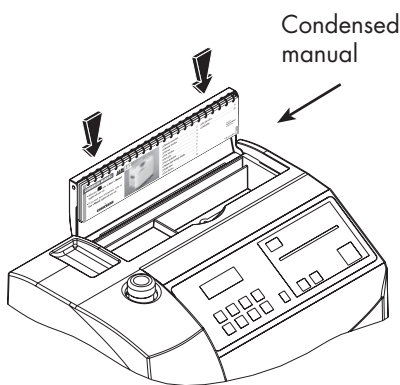

SUPPLIES	ASM 142	ASM 142 S	ASM 142 D	ASM Graph D+
User's Manual ASM 142 / 142 D	x		x	x
Condensed manual ASM 142 / 142 D	x		x	x
User's Manual ASM 142 S		x		
Condensed manual ASM 142 S		x		
Oil + Funnel	x	x		
A calibration certificate of the internal calibrated leak	x	x(1)	x	x
1 allen wrench # 5	x	x	x	x
1 screwdriver	x	x	x	x
1 vacuum hose	x	x		
1 vacuum connector	x	x		
Stikers units		x		
1 allen wrench # 2,5		x		
1 LDS probe		x		
Manual RS 232 (option)	x	x	x	x

(1) If internal calibrated leak option

If one of these parts is missing, contact the manufacturer immediately.

Storage For prolonged storage, factors such as temperature, humidity, saline atmosphere, etc. may damage the detector elements.

Please call your local representative for further information.

Before starting up after storage for over six months, it is recommended to change all the seals (contact customer service).

The seals kits must be kept away from heat and light (direct sunlight and ultraviolet light) in order to prevent hardening of the elastomers.

Unpacking - Storage - Transportation

Fixed mounting The ASM 142 can be fixed on a support: a threaded hole is available on the bottom of the unit to place a screw to keep it secure to a working surface such as a bench (except ASM Graph D+).

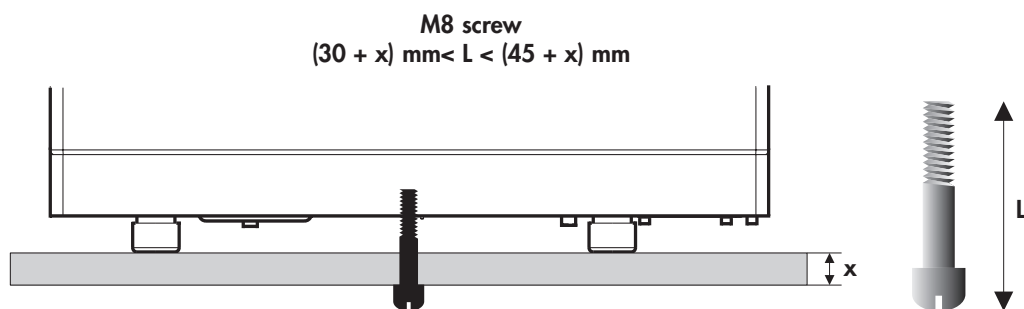

Transport Before expedition, we advise you to drain the primary pump to avoid any oil split (only ASM 142 - ASM 142 S).

Don't move leak detector when AMP pump is running.

We advise for any transport to use the original packaging and to wedge the detector carefully into the box.

Precautionary measures for the leak detector installation

Only for ASM Graph D+

The cart is equipped with 4 pivoting wheels with brake.

It is forbidden to place the cart on a sloping surface (> 1 %) without take precautions for its translation stop.

Neutral gas purge and inlet vent connection

Products concerned

	Inlet vent	Neutral gas purge
ASM 182 / 192 T ASM 192 T2	✓	
ASM 182 / 192 TD+ ASM 192 T2D+	✓	✓ ⁽²⁾
ASM 142	✓ ⁽¹⁾	
ASM 142 D ASM Graph D+		✓ ^(MDP 5006 HDS) ⁽³⁾
ASM 142 S ASM 102 S		
ASM 122 D	✓	✓ ⁽²⁾
ASM 1002	✓	

(1) Requires a special inlet vent kit installation ( **A 700**).

(2) Male connector delivered with the leak detector.

(3) Male connector not delivered with the leak detector.

Model : Male connector R 1/4 BSPT.

Connection to the leak detector

 **B 210 / B 211**

Neutral gas purge
ASM 182/192 TD+
ASM 192 T2D+
ASM 142 D

■ If no purge system is connected to connector which is connected to detector, the neutral gas purge is to the ambient air and maintained an air flow inside the leak detector.

Neutral gas purge
ASM 122 D

■ Even if the leak detector does not use the neutral gas purge, the male connector delivered with the leak detector should always be connected to leak detector.

Inlet vent

■ The inlet vent status (open or closed) depends on the parameters set by the operator ( **C 500**).

■ If no inlet vent system is connected, the inlet vent is connected to the ambient air.

Neutral gas purge and inlet vent connection

Use

Neutral gas purge

- Used to limit the leak detector internal pollution.
- Used to accelerate the cleanup of the helium background noise in the pumps after detecting a significant leak.
- Make high sensitivity testing easier due to the decreasing and stabilization of the helium background noise.
- As a supplement to the neutral gas purge, use the "Depollution" function  **C 560** (except ASM 142 S/ASM 102 S).



CAUTION

In case of a big flow of Helium into the leak detector (very big leak detected), the recovery time (time for the display to go back to normal Helium background value) is 10 times longer when the neutral gas purge is obturated than when it is open. In usual average test conditions, there is however no major difference.

Inlet vent

- Used to accelerate the cleanup of the helium background noise in the leak detector after detecting a significant leak.
- Make high sensitivity testing easier due to the decreasing and stabilization of the helium background noise.
- Allows to regulate the gas flow inside the leak detector, leak detector in stand-by.

Gas characteristics

Type

Nitrogen is typically the neutral gas used but you can use any gas on the condition that it is poor in helium (concentration ≤ 1 ppm). Take care with the ambient air: it should not be polluted with helium.

Quality/purity

According to the installation or item to test. The gas should be clean, dry, without dust, no toxic.

Use pressure

0.3 ± 0.1 bar relative (≈ 20 psia/5 psig).



If the inlet vent pressure is too high, the inlet valve will always stay closed, off even if the inlet valve is "ON".

Purge flow

- ASM 122 D - ASM 142 D: ≤ 5 sccm
- ASM 182 TD+: ≤ 50 sccm

Neutral gas purge installation (accessory) ASM 142

Object This accessory allows to connect to the standard air inlet of the detector a neutral gas purge.

Material Accessory **16**



 **A 700**

Installation



N2 port

N2 vent line

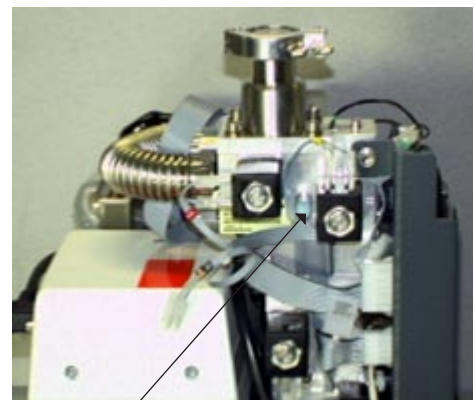

Filter to be removed

N2 vent line connected to the filter port

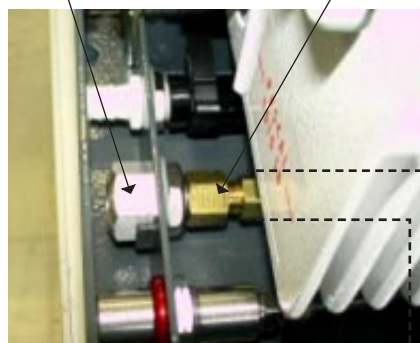

Connecting the detector to the installation

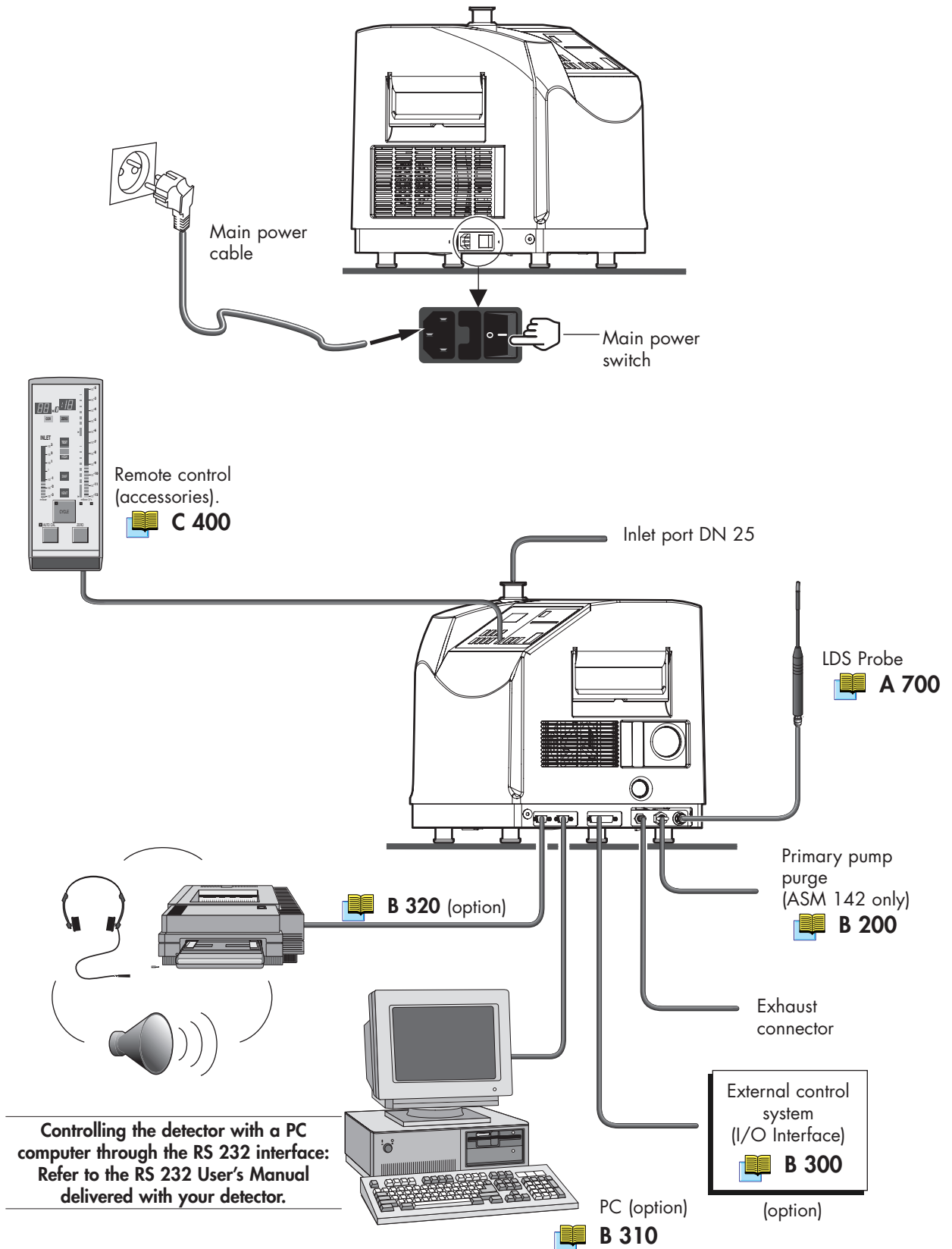

Connecting the detector to the installation: ASM Graph D+

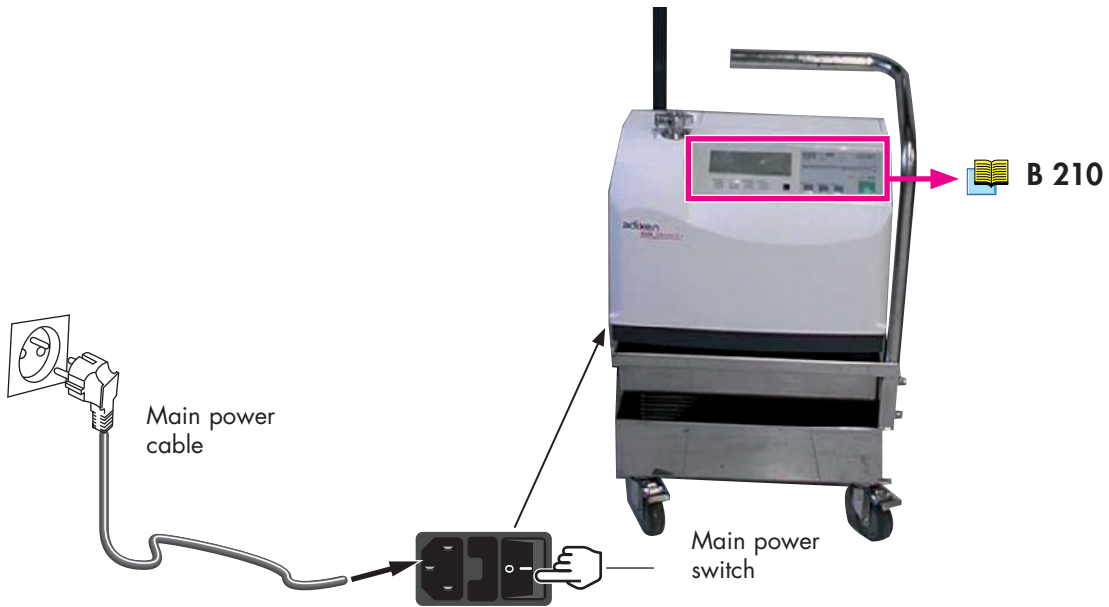

Controlling the detector with the I/O interface

Purpose of the I/O interface

The I/O interface makes it possible to control the leak detector with a PLC or any other external control device.

Location of the I/O interface

The I/O interface is available on a Sub D. 25 pin Female connector located on the back of the leak detector.

 **B 210**

Prepare the connector wiring (Sub D. 25 pin male connector)

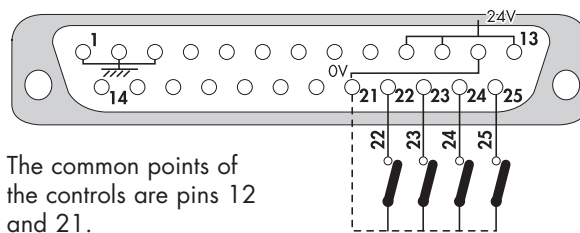

It is recommended to use a shielded cable which is grounded on the connector cap.

The controls (inputs)

22 Cycle	Sniffing start/stop
23 Calibration	Autocalibration sequence start
24 Zero	Zero function start
25 Inlet vent	Vent mode selection

The signals (outputs)

Dry contacts:
 Direct current: 60 V - 60 W or 2 A max
 Alternative current: 40 V - 125 VA or 2 A max
 Closed contact:

4 - 17	Sniffer mode (LDS)
6 - 19	Detector ready to test. Good part (PASS)
5 - 18	Defect
7 - 20	Cycle start
8 - 9	Detector ready to test. Bad part (FAIL)
2 - 15	Analog output 0 - 10 VDC corrected Exponent Helium signal
1 - 14	0 - 8 VDC tracer gas analogic output
3 - 16	Corrected Mantissa Helium signal

Nota :
 1 - 2 - 3 = internal ground
 12 = common (external ground)
 21 = common (external ground)

 **G 300**

Controlling the detector with the I/O interface

24 V DC Power supply

Pin No	24 V DC power supply
10, 11, 13	<p>If SW1 on P0307 interface board is closed (upper position) ⇨ +24V DC (maximum current 350 mA) supplied by leak detector</p> <p>If SW1 is open (lower position) ⇨ (+) point for customer external power supply (24 V)</p>
12, 21	<p>If SW1 on P0307 interface board is closed (upper position) ⇨ Ground</p> <p>If SW1 is open (lower position) ⇨ (-) point for customer external power supply</p>

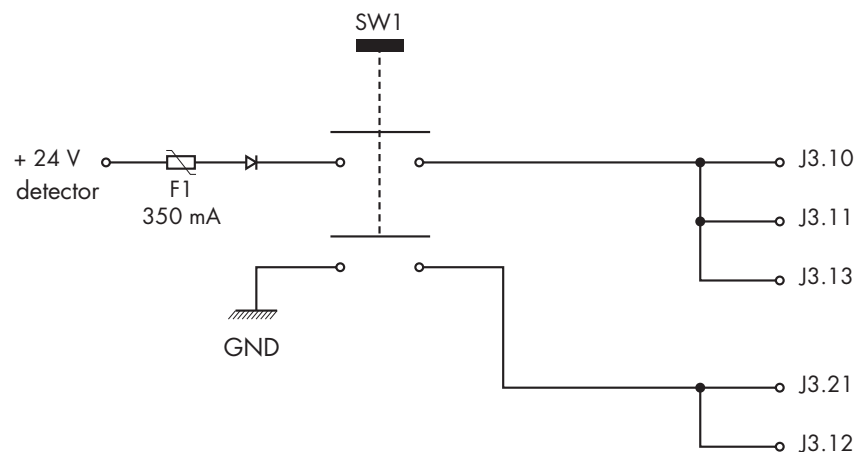

Controlling the detector with a PC computer through the RS 232 interface

Purpose of the PC computer interface

The RS 232 interface makes it possible to control the leak detector with a PC compatible computer.

Location of the RS 232 interface

It is a Sub D 9 pin Male connector.

Connect the detector to the installation  B 210/211

RS 232 interface instructions

A specific manual describes to the operator all the commands available with the RS 232 manufacturer protocol. It is delivery with your leak detector.

Commands available for your leak detector

Only the commands which correspond to the fonctions of your leak detector are available.

See details in the RS 232 User's manual.



RS 232 interface setting

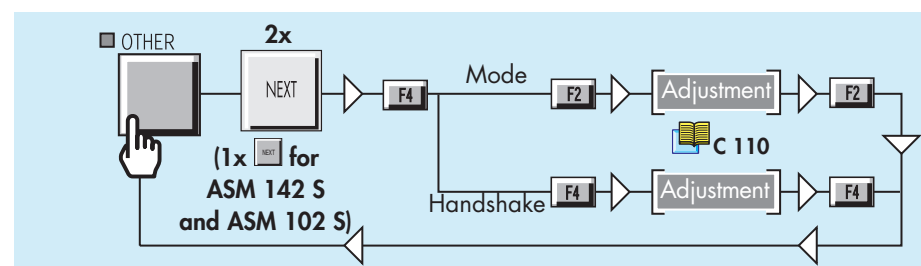

Connection checking of RS 232 interface

You can start up an autotest in order to check the connection PC/leak detector.

Leak detector stationary, connect the both ends of RS 232 cable (depending on wiring recommended) on each of Sub 9 pins connectors.

Controlling the detector with a PC computer through the RS 232 interface

Procedure 1 -

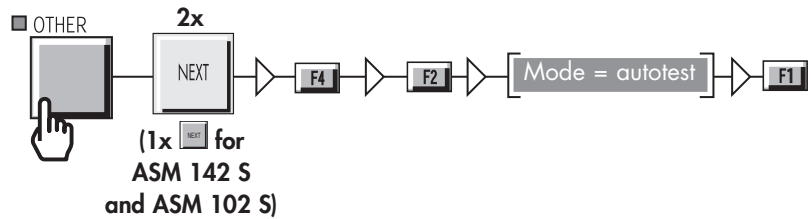

2 - The first line of LCD screen is:

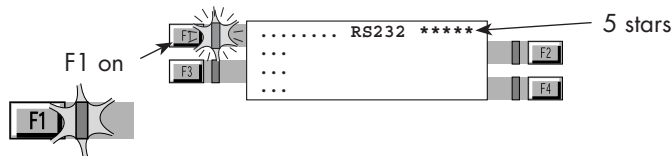

3 - the autotest is started and F1 flash on

Following different tests, the stars are replaced by numbers.
If the autotest is accomplished, the first line LCD screen become:

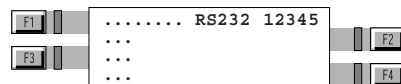

Connecting the detector directly to a printer or another device

Purpose of the printer interface

The Printer interface makes it possible to connect the leak detector to a printer, an external loudspeaker or a headphone.



Location of the printer interface

It is a Sub D 9 pin Male connector.

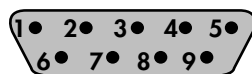
 **B 210/211**



Connector description

	Pin #	Function	Communication protocol	
	1	External loudspeaker	Mode	Asynchronous
	2	Rx	Bauds	9600
	3	Tx	Bits	8
	4	NA	Parity	None
	5	Ground	Stop bit	1
	6	Headphone	Parity control	None
	7	RTS		
	8	CTS		
	9 	Internal use only. Don't connect it		

Headphone and loudspeaker  **C 410**

Communication mode description



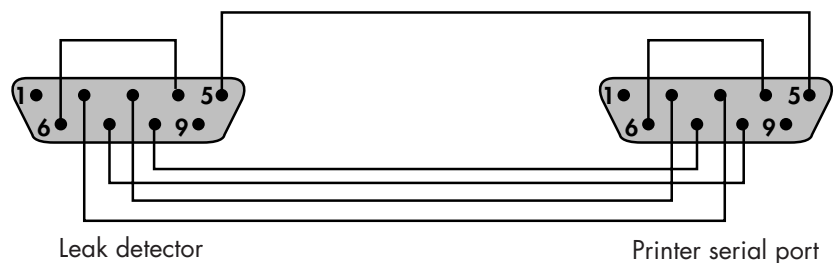

Configuration tickets are sent out.

Connection to the printer



Connecting the detector directly to a printer or another device

Tickets available

Ticket	Example	Print
Configuration	1	Only available for Customer Service
Internal calibration with internal leak	2	Automatic print after an internal calibration with internal/external leak: refer to  C 301
Internal calibration with external leak	3	
Calibration checking with internal leak	5	Automatic print after a calibration checking with internal leak: refer to  C 302
Test	6	Automatic print at the test end: refer to  C 211 / 212  Memo function must be active  C 550

Connecting the detector directly to a printer or another device

Configuration ticket

1

ASM1002 CONFIGURATION TICKET

VERSION: L125v1.0 r00

DATE:Jan/01/2003 TIME:00:00:07

SET-POINTS MENU

audio level:	3
digital voice level:	3
hard vacuum alarm:	fixed
hard vacuum reject point:	1.0E-07
sniffing alarm:	fixed
sniffing reject point:	1.0E-04
sniffer probe clogged reject:	1.0E-06
bargraph zoom on reject point:	no
depollution function:	off
pollution reject point:	1.0E-05
antipollution GL function:	on
pollution reject point:	3.0E-04
memo. function active:	no
memo. display timer:	no
memo. timer value(min:s):	00:10
cycle end function:	operator
roughing overlap timer:	on
roughing timer value(min:s):	00:10
test timer value(min:s):	00:10
start.timer value(min:s):	00:05
background suppression activation:	operator
trigger:	reject point
GL setpoint (mbar)	1.0E+02
Normal setpoint (mbar)	1.0E-01

SPECTRO MENU

automatic calibration:	off
calibration check:	operator
every:	0050 cycles
every:	0010 hours

filament in use:	2
electronic zero:	110
acceleration voltage(V):	217
electronic current(mA):	0.0
sensitivity coefficient:	01.00
He calibrated leak location:	internal
value:	1.0E-07
unit:	mbar.l/sec
year:	2003
loss per year(%):	2.00
temperature(C):	20
temp.coefficient(%/C):	3.00

MAINTENANCE MENU

high vac.mnt.periodicity(hours):	12000
high vac. mnt.due in(hours):	12000
filament#1 running time(hours):	0
filament#2 running time(hours):	0
customed mnt.period.(cycles):	5.0E+05
customed mnt.due in(cycles):	5.0E+05
bicolore remote:	yes
primary pump1 used:	yes
primary pump2 used:	no

OTHER MENU

test mode selection:	normal
inlet vent mode:	chamber
inlet vent delay(sec):	0
inlet vent open timer us:	no
inlet vent timer value(min/sec):	00:09
hard vacuum correction:	off
hard vacuum cor.coefficient:	1.00E+00
sniffing correction:	off
sniffing cor.coefficient:	1.00E+00
unit:	mbar.l/sec
display language:	english
user interface:	#4
password value:	5555

TYPICAL VACUUM VALUES

Pu_gf:1.00000	Mu_gf :1.0E+06
Pu_n :1.00000	Mu_n :00001.0
	Mu_rld:00015.0

DATE AND TIME VALUES

last stop:	Jan/01/2003 00:00:00
last start:	Jan/01/2003 00:00:02
last calib.ok:	Jan/01/2003 00:00:00

detector counter (h:m:s):	00000:00:50
---------------------------	-------------

Connecting the detector directly to a printer or another device

Calibration ticket with internal calibrated leak

2

```

DATE:Jan/01/2003 TIME:00:03:17
ASM1002 CALIBRATION gas: He
unit: mbar.l/sec

CALIBRATED LEAK PARAMETERS:
location: internal
value: 1.0E-07
unit: mbar.l/sec
calibration year: 2003
loss per year (%): 2.00
calibration temperature (C): 20
temperature coefficient (%/C): 3.00
TARGET PARAMETERS:
current internal temperature (C): 25
target value: 1.2E-07
ELECTRONIC ZERO:
done: yes
PEAK SEARCH :
search: yes
SIGNAL RECORDS (no calibrated):
global: 1.3E-07
background: 7.1E-11
CALIBRATION INFORMATIONS:
total time(sec): 74
result: COMPLETED

CURRENT ASM1002 CALIBRATION:
DATE:Jan/01/2003 TIME:00:03:00
Fil:1 le=0.6 Vacc=232 Coef_sens:00.86
    
```

Calibration ticket with external calibrated leak

3

```

DATE:Jan/01/2003 TIME:00:05:03
ASM1002 CALIBRATION gas: He
Unit : mbar.l/sec

CALIBRATED LEAK PARAMETERS:
location: external
value: 1.0E-05
unit: mbar.l/sec
calibration year: 2003
loss per year (%): 2.00
calibration temperature (C): 20
temperature coefficient (%/C): 3.00
TARGET PARAMETERS:
current external temperature (C): 22
target value: 1.1E-05
ELECTRONIC ZERO:
done: no
PEAK SEARCH :
search: no
SIGNAL RECORDS(no calibrated):
global: 2.0E-05
background: 3.0E-09
CALIBRATION INFORMATIONS:
total time(sec): 64
result: COMPLETED

CURRENT ASM1002 CALIBRATION:
DATE:Jan/01/2003 TIME:00:05:02
Fil:1 le=0.6 Vacc=232 Coef_sens:00.52
    
```

Connecting the detector directly to a printer or another device

Calibration checking ticket with internal leak

5

```

CALIBRATION INFORMATIONS:
DATE|Jan/01/2003 TIME|01:19:23
current internal temperature(C)|          24
current coef.sens|                        00.78
global rate|                              1.10E-07
background rate|                          5.22E-11
calibrated leak-rate|                     1.10E-07
target value|                             1.10E-07
percent allowance (+/-)|                  15
RESULT(%)|                                -0
    
```

Test ticket

6

```

DATE:Jan/01/2003
  HOUR      CASE      PRESSURE      LEAKRATE
00:28:26   start     3.8E+01     3.4E-11
00:28:55    GL       1.2E-02     1.4E-09
00:29:40    NR       6.3E-05     9.1E-06
00:29:45    stop     5.8E-05     1.1E-05
              NR
    
```

Leak value

```



DATE:Jan/01/2003
  HOUR      CASE      PRESSURE      LEAKRATE
01:02:31   start     6.5E+01     4.8E-11
01:02:32    GL       4.6E+01     4.8E-11
01:02:33    NR       5.9E-02     1.8E+00
01:02:36    stop     9.9E-05     1.3E-05
              NR
    
```

Leak value

Test result if Memo function active

Memo function  C 550

Before starting up the leak detector

Please acquaint oneself with the safety instructions sheet ( B 100) and the installation sheet ( B 110)

The performance of the detector (pumping speed, accuracy and reliability) depends on:

- the vacuum connections
- the frequency and quality of maintenance
- the helium calibration.

Check power voltage

Check that the power voltage is compatible with the power configuration of the leak detector: check the indications of the label located close to the power switch.

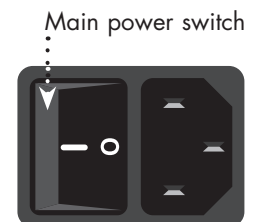

Check the oil level of the rotary vane pump (ASM 142 - ASM 142 S)

The pump has been drained: a label affixed on the cover of the unit indicates this and the filling oil is supplied.

NOTICE
PUMP IS SHIPPED WITHOUT
 **OIL INSTALLED**
consult maintenance manual
CAUTION

Recto

ATTENTION
POMPE LIVREE SANS HUILE
 **A L'INTERIEUR**
consulter le manuel d'utilisation
ATTENTION

Verso

Maintenance of the primary pump  E 750



The pump will be damaged if it runs without oil. (> 5 mn).



The oil required for the first use is supplied with the detector. Replacement of oil is the user's responsibility. The pumps have been tested with A200 oil. The technical characteristics of the pump are guaranteed only with the recommended oil.

Installation

Position the unit so there is no possible risk of it falling or tilting.



Detailed contents

Preliminary remarks Throughout this User's Manual, you could find this type of message "Summary of screen  C 140": it refers to a specific chapter of the User's Manual. Please read it for further information.

C 100 *Factory configuration of the leak detector parameters*

- Parameters configuration

C 110 *Operating principle of the control panel*

- General
- Graphic interface option
- Control keys
- Menu selection access keys
- Parameter function keys
- Description of access key
- Values adjustment with the control panel

C 120 *Setting and maintenance part presentation of the control panel*

- Levels
- Parameters setting and application depending on level and display of the user interface

C 130 *Access to level - Password*

- To access to level 
- Change password

C 140 *Summary of screens*

- Other menu
- Spectro menu
- Set point menu
- Maintenance menu

C 200 *Starting up / Switching off the leak detector*

- Starting up after an unused/storage period
- Starting up the leak detector
- Switching off the leak detector
- Recommended procedure

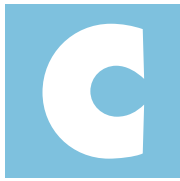

ASM 142 - ASM 142 D ASM GRAPH - ASM GRAPH D ASM GRAPH D+ Detailed contents

C 210

How to use the leak detector: 2 methods

- How to use your leak detector?
- Hard vacuum test mode
- Sniffing test mode

C 211

Operation of the leak detector

- Hard vacuum test
- Sniffing test
- Sniffer probe clogged reject point
- Adjust vacuum/sniffing alarm reject point

C 300

Calibration of the leak detector

C 301

Basic internal calibration of the leak detector

- Purpose of the internal calibration
- When should an internal calibration be performed?
- Internal calibrated leak
- Internal calibration with the internal He calibrated leak
- Internal calibration with an external calibrated leak

C 302

Advanced internal calibration of the leak detector

- Introduction
- Activation/deactivation of the internal calibration
- Checking function

C 303

External calibration of the leak detector

- Purpose of the external calibration
- External calibrated leak
- Digital and analog display
- External calibration procedure
- Checking function with an external calibrated leak

C 304

Correction factor

- Definition
- Activate/Deactivate the correction factor VACUUM/SNIF COR Adjustment
- General notes (vacuum or sniffing test mode)

C 305

Calibrated leak values programming

- Different types of calibrated leaks
- Programming the calibrated leak parameters



ASM 142 - ASM 142 D ASM GRAPH - ASM GRAPH D ASM GRAPH D+ Detailed contents

C 306

Adaptor for calibrated leak in sniffing mode

- How to use the adaptor?
- Notes

C 400

Remote control

- Remote control interface
- Remote control connecting
- Remote control choice
- Use and display

C 410

Headphone and loudspeaker

- Level adjustment
- Accessories
- Configuration

C 430

3 masses option

- Purpose
- Gas selection
- Calibration in Hydrogen or Helium 3

C 440

Control panel with graphic interface

- Graphic interface purpose
- Leak detector software version
- Automatic standby screen
- Use caution
- Control panel interface
- Change of interface
- Operating principle of the standard interface
- Operating principle of the graphic interface
- Selection of the graphic interface use mode
- Graphic interface description
- Graphic interface setting
- Memorized graph
- Animated synoptic

C 450

Long distance sniffer probe and Helium spray gun

C 500

Inlet vent

- Choices proposed to the operator
- Air vent purpose
- Air vent Opening/Closing
- Air vent adjustment



ASM 142 - ASM 142 D ASM GRAPH - ASM GRAPH D ASM GRAPH D+ Detailed contents

C 510

Bargraph zoom

- Purpose
- Activate/deactivate the bargraph zoom
- Analog display
- Zero function & Bargraph zoom

C 520

Audio alarm / Digital voice

- Audio alarm definition
- Digital voice definition
- General
- Sound level
- Adjustment

C 530

Cycle end

- Purpose of the cycle end
- Activate/Deactivate the Cycle end

C 540

Zero function

- Purpose
- Activate the zero function
- Deactivate the zero function
- Activation/Deactivation of the background
- Display

C 550

Memo function

- Purpose
- Activate/Deactivate the memo function

C 560

Helium pollution prevention

- Purpose
- Activate/Deactivate the Helium pollution prevention

C 570

Date - Time - Language - Unit

- Adjustment procedure

C 580

Fault / information indicator and display

- Fault and information
- Faults
- Information
- List of messages

Factory configuration of the leak detector parameters

Parameters configuration

The following list indicates the factory configuration of the leak detector parameters.

When the leak detector is switched off, all set parameters are memorized and values are kept for the next start-up.

We advise you to note in the "Customer modification" column, the parameter values modified for your application.

Parameters	Configuration		
	Factory	Customer modification	
Test mode	Normal		C 210
Sniffer probe clogged threshold	$1 \cdot 10^{-7}$ mbar./s		C 211
Autocalibration Activation Auto-checking every ... Auto-checking every ...	On Operator 10 hours 100 cycles		C 302
External calibrated leak in test External calibrated leak in sniffing	$1 \cdot 10^{-7}$ mbar./s $5 \cdot 10^{-6}$ mbar./s		C 303
GL correction GL correction value Sniffing correction Sniffing correction value	Off 1 Off 1		C 304
Calibrated leak parameters	See calibration certificate of the internal calibrated leak delivered with the detector.		C 305
Password	5555		C 130
User interface level	2		C 120
Audio alarm Voice synthesis Reject point in hard vacuum Reject point in sniffing	3 4 $1 \cdot 10^{-8}$ mbar./s $1 \cdot 10^{-6}$ mbar./s		C 520
Detector Inlet vent Inlet vent activation Delay Open timer use Timer	Off Operator 0 No 00:10		C 500
Depollution Depollution reject point	On $1 \cdot 10^{-5}$ mbar./s		C 560

Factory configuration of the leak detector parameters

Parameters	Configuration		
	Factory	Customer modification	
Memo function Display timer Display timer value	No No 00:10		C 550
Bargraph zoom	No		C 510
Cycle end Roughing timer Roughing timer value Measure timer value	Operator Yes 00:10 00:10		C 530
Background suppression Trigger	Operator Reject point		C 540
Date - Time Language - Unit	Factory leaving Requested in the customer order		C 570
Gas for 3 masses option	He		C 430
Maintenance required	$1 \cdot 10^6$ cycles		D 100

Operating principle of the control panel

General

Operator interface  A 500

If a key (sensing switch) is depressed when its function is not available or not authorized, a brief audio signal is emitted.

Graphic interface option

If your control panel is equipped with a graphic interface, please refer to the sheet  C 440 which completed this sheet.

Control keys

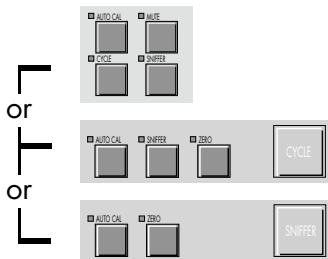

The LED indicator is **ON** when the control key is activated (ex.: Sniffer ON).



The LED indicator is **OFF** when the control key is deactivated (ex.: Sniffer OFF).

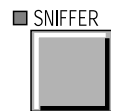

Menu selection access keys

The LED indicator comes **ON** after depressing the key. It activates the menu.

Then the corresponding menu is shown on the alphanumeric display.



Pressing the corresponding Menu selection key a second time deactivates the menu. The LED indicator is then turned **OFF** and the previous screen is displayed again.

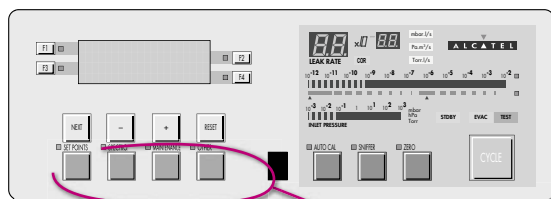
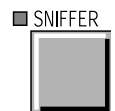

(standard)

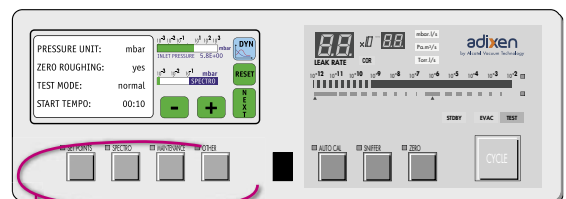

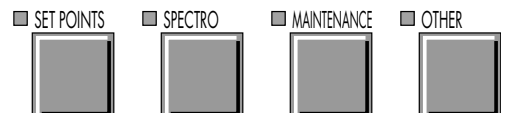
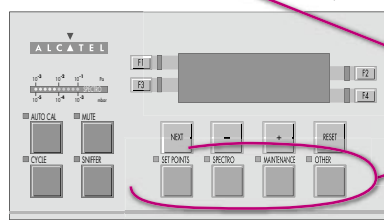

(option/accessory)



Menu selection access keys

Operating principle of the control panel

Parameter function keys

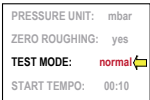
Standard control panel	Control panel with graphic interface (option/accessory)
	
<ul style="list-style-type: none"> To access to the parameter to be changed, there are up to 4 function keys available on the alphanumeric display (F1, F2, F3 and F4). Only one parameter key can be activated at a time. 	<ul style="list-style-type: none"> No function keys : to access to the parameter to be changed, press on the parameter value. Only one parameter value can be activated at a time.
<p>Press F1 = press on the 1st line red value</p> <p>Similarly:</p> <p>F2 → 2nd line, F3 → 3rd line ; F4 → 4th line</p> <p>Note: In the user's manual, all the functions are explained with F1 to F4 function keys.</p>	
<ul style="list-style-type: none"> The LED indicator is ON when the corresponding function key is available: the modification of the parameter displayed on the line is authorized. 	<ul style="list-style-type: none"> The value parameter is red when the corresponding parameter is available for modification.
<ul style="list-style-type: none"> Press the function key: the LED indicator will flash: the modification can be performed. It is possible to escape and reset the previous value by pressing RESET key or the active menu selection key. 	<ul style="list-style-type: none"> Press on the value: a arrow appears. the modification can be performed.  <p>It is possible to escape and reset the previous value by pressing RESET key or the active menu selection key.</p>
<ul style="list-style-type: none"> Once the parameter is modified, pressing the function key again validates it: the LED indicator remains ON and stops flashing. 	<ul style="list-style-type: none"> Once the parameter is modified, pressing the red value again validates it: the arrow disappears.

Operating principle of the control panel

Description of access keys



Next menu or next step of a function, Next PARAMETER DIGIT, WARNING/ERROR message display on the LCD when an error is detected.

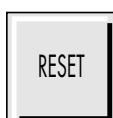

Resets original parameter value (before a new parameter value is validated) and deactivates the parameter key.



YES, or ON, or OPEN, or active, or increase value, or increase audio volume, or select more sensitive test mode.

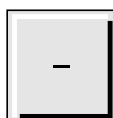

NO, or OFF, or CLOSE, or deactivate, or decrease value, or decrease audio volume, or select less sensitive test mode.

Values adjustment with the control panel

In many menus, some values can be adjusted (reject point, password, timer, ...).

Please follow the procedure described below.

Procedure

Press function key of the desired line (where the value needs to be adjusted).

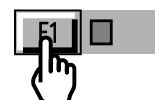

For each parameter, use modification keys in order to adjust the value and go to the next parameter.

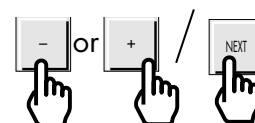

Repeat the same operation as needed.

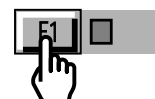

After the last modified parameter, press again the function key to validate the changes.

Setting and maintenance part presentation of the control panel

The control panel can be divided into two different sections.

- The section located on the right of the control panel is dedicated to the user.
- The section located on the left of the control panel dedicated to the setting and maintenance (adjustments, functions, menu access, etc.).

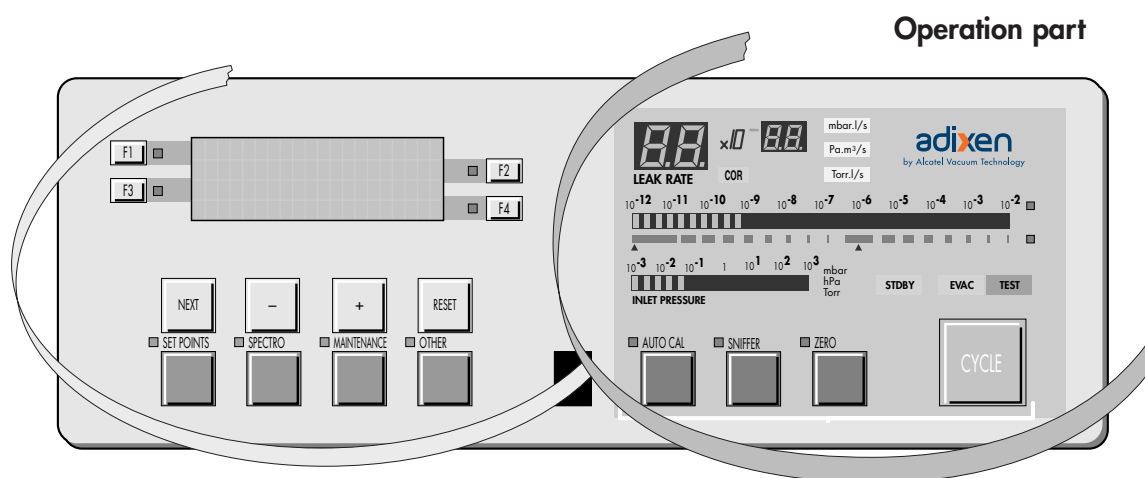

Setting and maintenance part

- Levels** • The detector offers **4 user interface levels** for this section to accommodate any application requirements.

Description

	Setting and maintenance part	User part
Level ①	This level has very limited information on the alphanumeric display (LCD). This level is generally selected for production types of applications.	No access to control keys (Cycle key included)
Level ②	This level allows the operator to visualize some parameters without the possibility of making any changes. Same as Level ①, this level is usually selected for production types of applications.	Access to all the control keys
Level ③	Same as level ② but with possibility to set some parameters. This level is generally selected for maintenance applications.	
Level ④	This level allows access to all the parameters and is generally used for settings all the parameters. Note: When switching from level ④ to any other level, the switch can be performed without using the password. This level is generally selected for R&D applications.	

Setting and maintenance part presentation of the control panel

Which is your user interface level?

In order to find out what is the current interface level, follow the sequence described below:

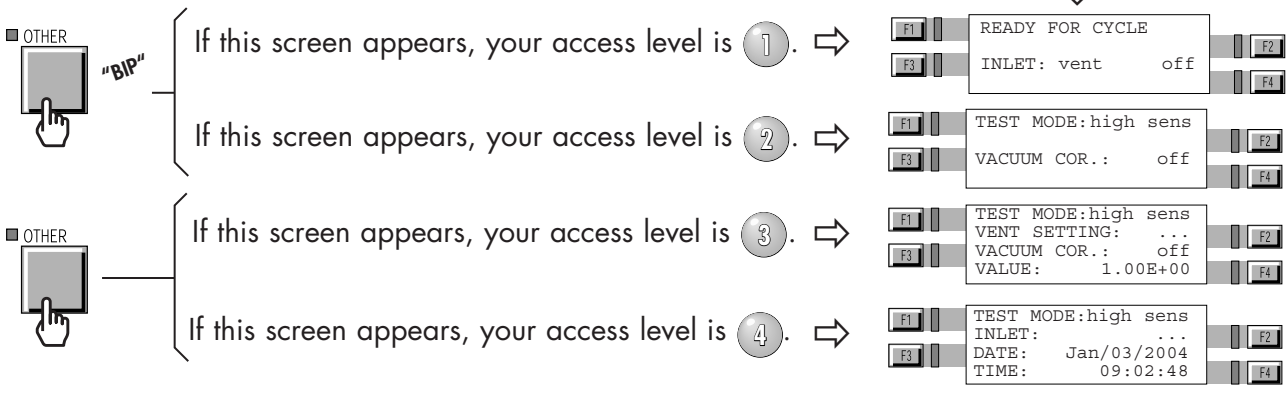

To change user interface level

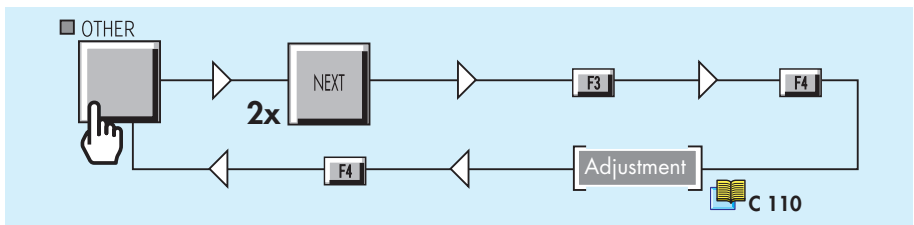

Setting and maintenance part presentation of the control panel

Parameters setting and application depending on level and display of the user interface

Function (with its associated parameters)		User Interface				Detector		
		Level required for setting parameters				ASM 142 ASM 142 D ASM Graph D+ ASM 122 D ASM 182 ASM 192 T ASM 192 T2 ASM 182 ASM 192 TD+ ASM 192 T2D+	ASM 142 S	ASM 102 S
Level 1	Level 2	Level 3	Level 4					
RS 232	RS 232 User's Manual				✓	✓		
User interface	C 120				✓	✓	✓	✓
Password	C 130				✓	✓	✓	✓
Test mode	C 210			✓	✓	✓		
Sniffer probe clogged threshold	C 211				✓	✓	✓	✓
Hard vacuum/Sniffing reject point	C 211			✓	✓	✓		
Auto-calibration (setting)	C 302				✓	✓	✓	✓
External calibration	C 303			✓	✓	✓		
Correction factor	C 304				✓	✓	✓	✓
Calibrated leak	C 305				✓	✓	✓	✓
Inlet vent	C 500		✓	✓	✓	✓		
Bargraph zoom (requires the remote control accessory)	C 510				✓	✓	✓	✓
Audio alarm	C 520			✓	✓	✓	✓	✓
Digital voice	C 520			✓	✓	✓	✓	✓
Cycle end	C 530				✓	✓		
Zero function	C 540				✓	✓		
Memo function	C 550				✓	✓		
Helium pollution prevention (depollution)	C 560				✓	✓		
Date - Time - Language - Unit	C 570				✓	✓	✓	✓
Gas line	C 420				✓	✓ (*)		
3 masses option	C 430				✓	✓		✓
Maintenance required	D 200				✓	✓	✓	✓
Filament information	E 400				✓	✓	✓	✓
Calibration mode	C 300				✓			✓

(*) only ASM 182 TD+

Access to level 4 - Password

A help for control panel utilization/access.

Operating principle of the control panel

C 110

Setting and maintenance part presentation of the control panel

C 120

Access to parameters and parameters active depending on authorization

Access to level 4 - Password

C 130

Summary of screens

C 140

Complete displays list with access way and associated sheet

To access to level 4

Notes:

This procedure allows the operator (with level 1, 2 or 3) to access temporarily to level 4 to adjust a function but the level 4 isn't kept in memory and the unit will go back to its previous interface level afterwards. If the operator wants to maintain the level 4, he must change the user interface level (see "To change user interface level").

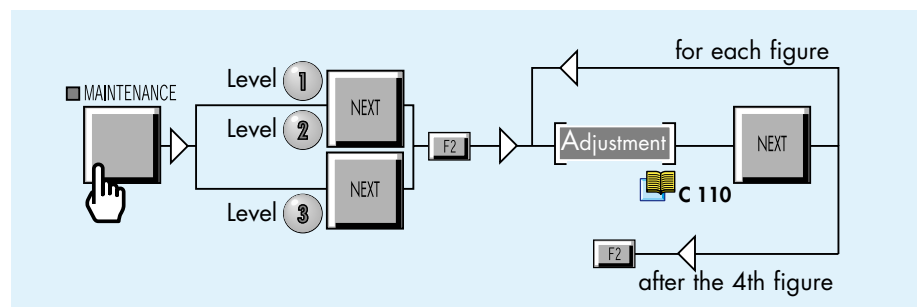

The operator has now reached the level 4. The software will automatically come out of level 4 and go back to the previous used level.

Change password

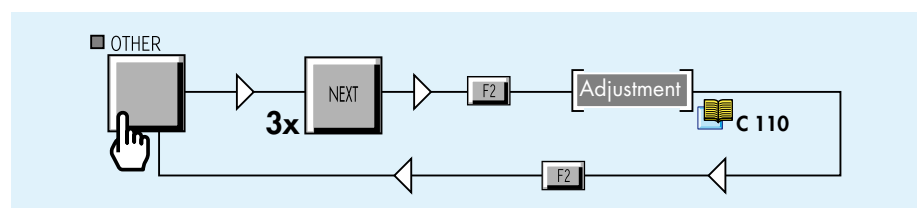

Summary of screens



Stand-by

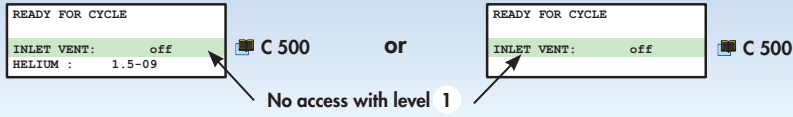

Starting-up

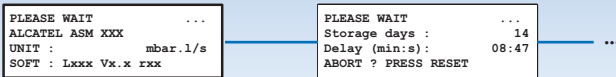

Password



Internal calibration with external calibrated leak

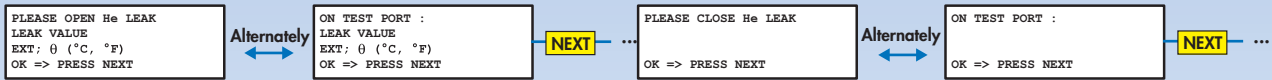

External calibration

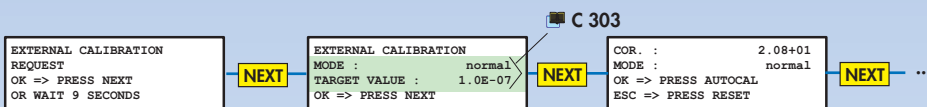

Summary of screens

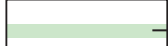
Other menu  → value/function adjustable

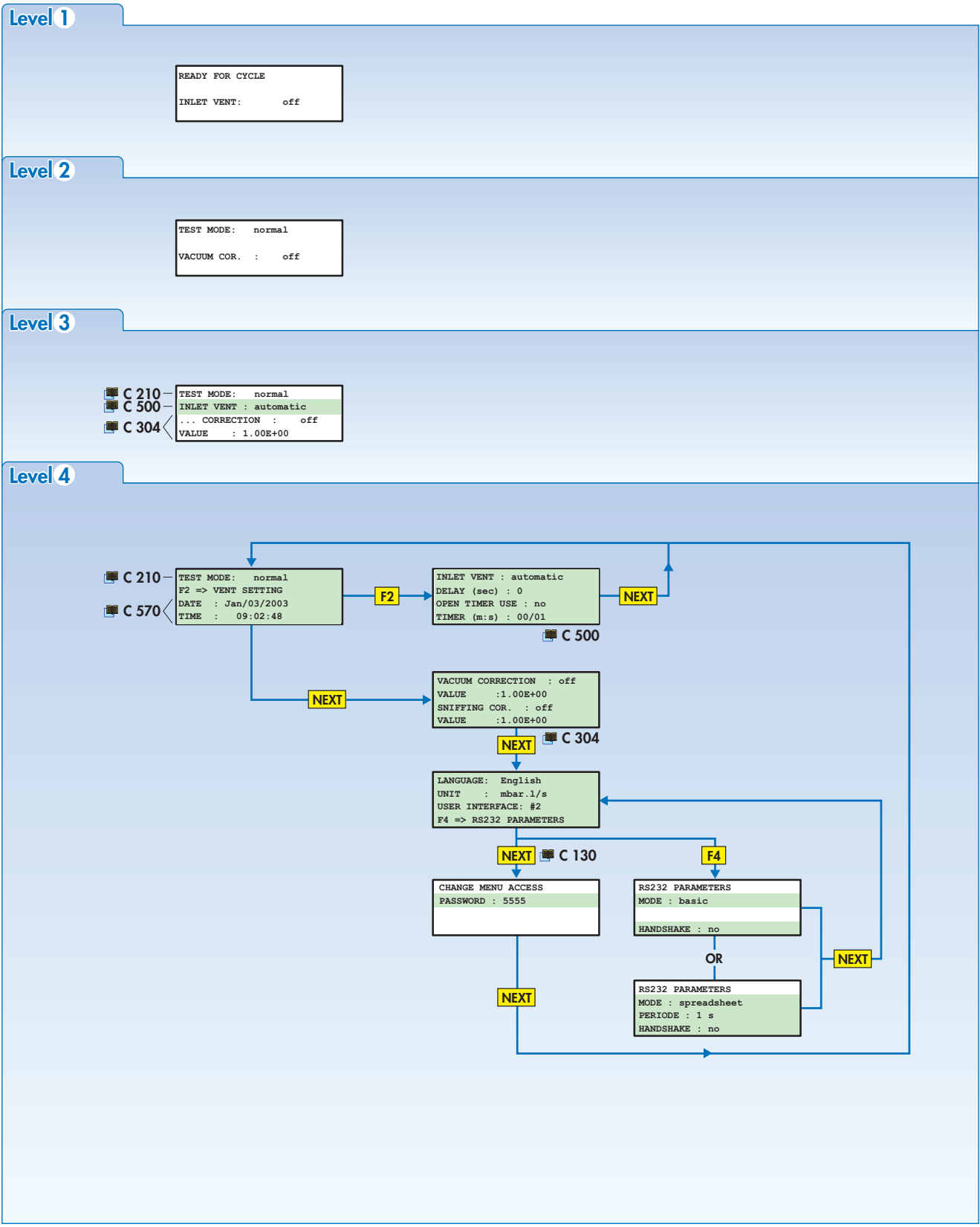

Summary of screens



Spectro menu

Level 1

```

READY FOR CYCLE
INLET VENT:   off
    
```

Level 2

```

SPECTROMETER
FILAMENT#1   :   on
TRIODE PRESSURE : 1
MARGIN       : 100%
    
```

Level 3

```

SPECTROMETER
FILAMENT#1   :   on
TRIODE PRESSURE : 1
MARGIN       : 100%
    
```

E 400

Level 4

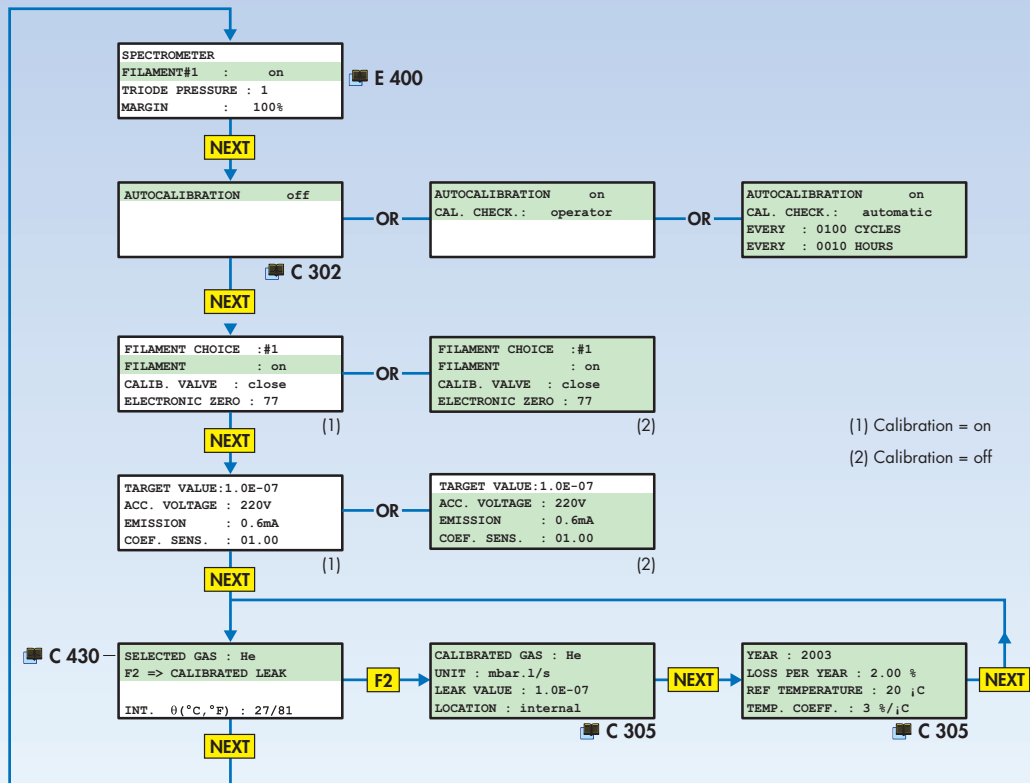

Summary of screens



Set point menu

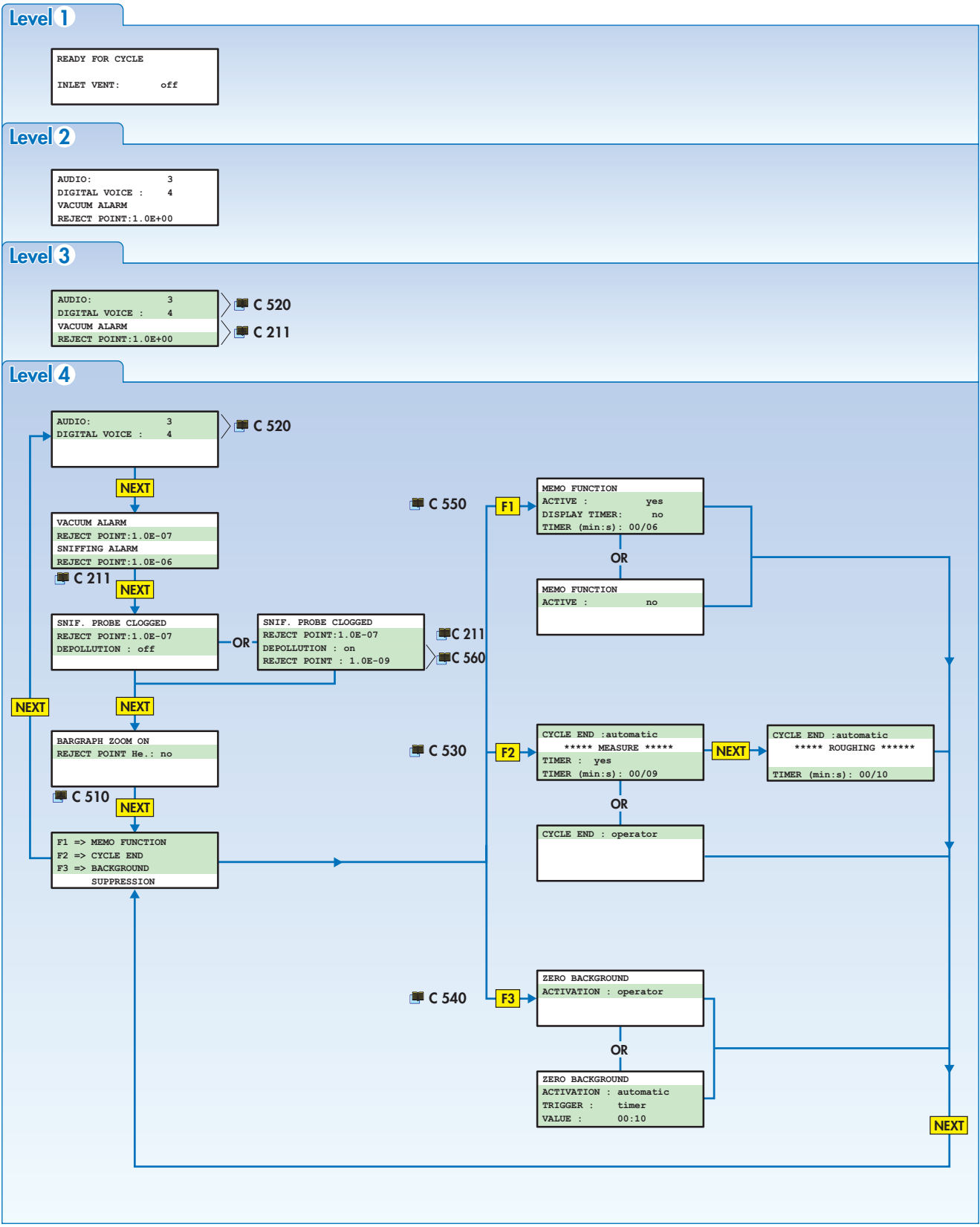

Summary of screens

 value/function adjustable

Maintenance menu

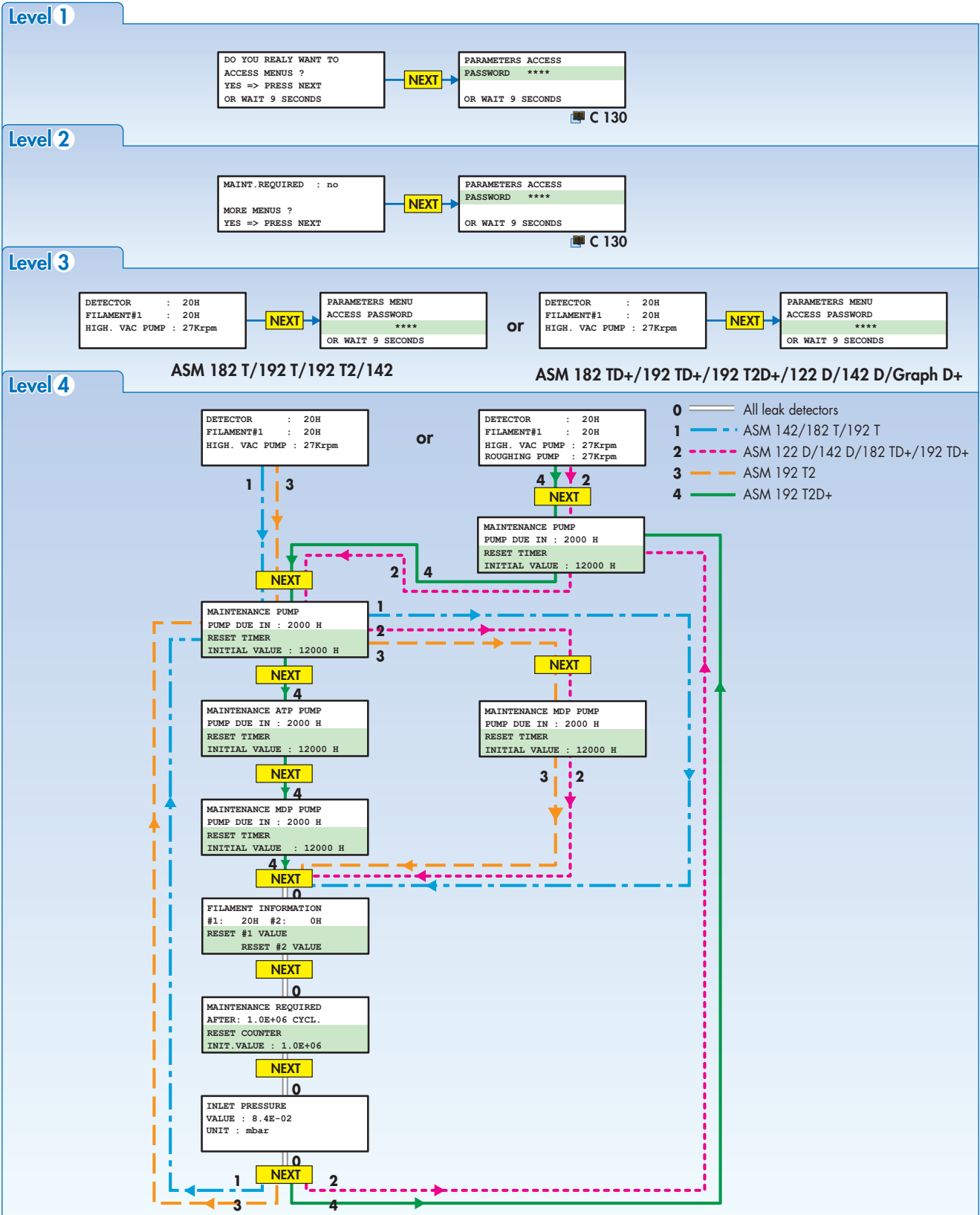

Starting up / Switching off the leak detector



Starting up after an unused/storage period

- If the operator uses the leak detector, after an unused or storage period, there is an additional time at the normal start-up time for outgassing:
 - inactivity period ≤ 10 days $\Rightarrow + 5$ s maxi (ASM 182, 192, 1002).
 - 10 days $<$ inactivity period ≤ 23 days $\Rightarrow + 3$ min.
 - inactivity period > 23 days $\Rightarrow + 10$ min
 - inactivity period ≤ 10 days $\Rightarrow + 10$ s maxi (ASM 142, 142 D, Graph D +, 122 D).

Technical characteristics A 800/801

- A screen informs the operator in the start-up process:

PLEASE WAIT
 Storage days: 14
 Delay (min:s): 08:47
 ABORT? PRESS RESET



 Number of days since the last leak detector switching off
 Count down of the additional time

RESET

The operator can cancelled this additional time by pressing .

Starting up the leak detector

Before starting up the detector B 400.

- Connect the main power cable of the detector to the proper power outlet.
- Turn main power switch in the ON position ( B 210). The indicator lights on the control panel flash.
- If your leak detector is equipped with «control panel with graphic interface» option, please refer to the sheet  C 440 for the mode choice.

The following is shown on the LCD during 2 seconds.

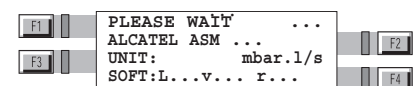

As soon as the power is ON, the pumps start.

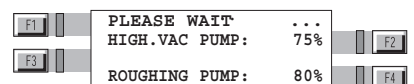

Audio messages inform the operator about starting-up process during this one.



- If leak detector auto-calibration is ON \Rightarrow 1
- If leak detector auto-calibration is OFF \Rightarrow 2

If a printer is connected, a calibration ticket is automatically printed at the end of the calibration: examples  2 ,  4  B 320.

Starting up / Switching off the leak detector

Starting up of the leak detector (continued)

1

When the pumps have reached their nominal speed, the unit auto-calibrates: different screens will show.

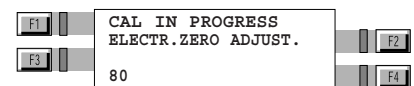

...

When calibration is completed, the unit is ready to start a cycle.

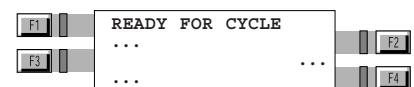

The digital voice gives to the operator the message: **"detector ready for cycle"**.

2

When the filament is OK, the unit is ready to start a cycle. A « i » is flashing at the right end of the 1st line of the LCD.

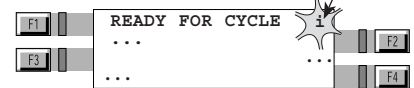

It informs the operator that the unit is in manual calibration: it will remain in manual calibration until operator performs an auto-calibration.

Information message C 580

Internal calibration on request C 300

Note: It is possible to start a test cycle even if the detector is not calibrated.

Switching off the leak detector

The leak detector can be switched off at any time by depressing the main power switch to 0 (OFF) **but** it is recommended (especially when the leak detector may not be used for an extended period of time) to stop it following the procedure described below.

Starting up / Switching off the leak detector

Recommended procedure

To protect the internal vacuum components of the leak detector against dust or any kind of contamination, it is recommended to keep its inlet blanked-off and under vacuum. Please proceed as follows before stopping the leak detector:

- Place the blank-off flange or close the test chamber.
- Start the test cycle.
- Wait until the leak detector reaches the more sensitive test mode. Make sure that the inlet vent is OFF.
- Stop the test cycle.
- Stop the leak detector.

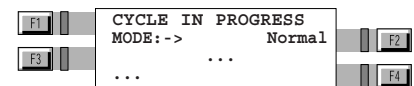

Inlet vent  C 500

How to use the leak detector: 2 methods

A help for control panel utilization/access.

Operating principle of the control panel

 C 110

Setting and maintenance part presentation of the control panel

 C 120

Access to parameters and parameters active depending on authorization

Access to level 4 - Password

 C 130

Summary of screens

 C 140

Complete displays list with access way and associated sheet

How to use your leak detector ?

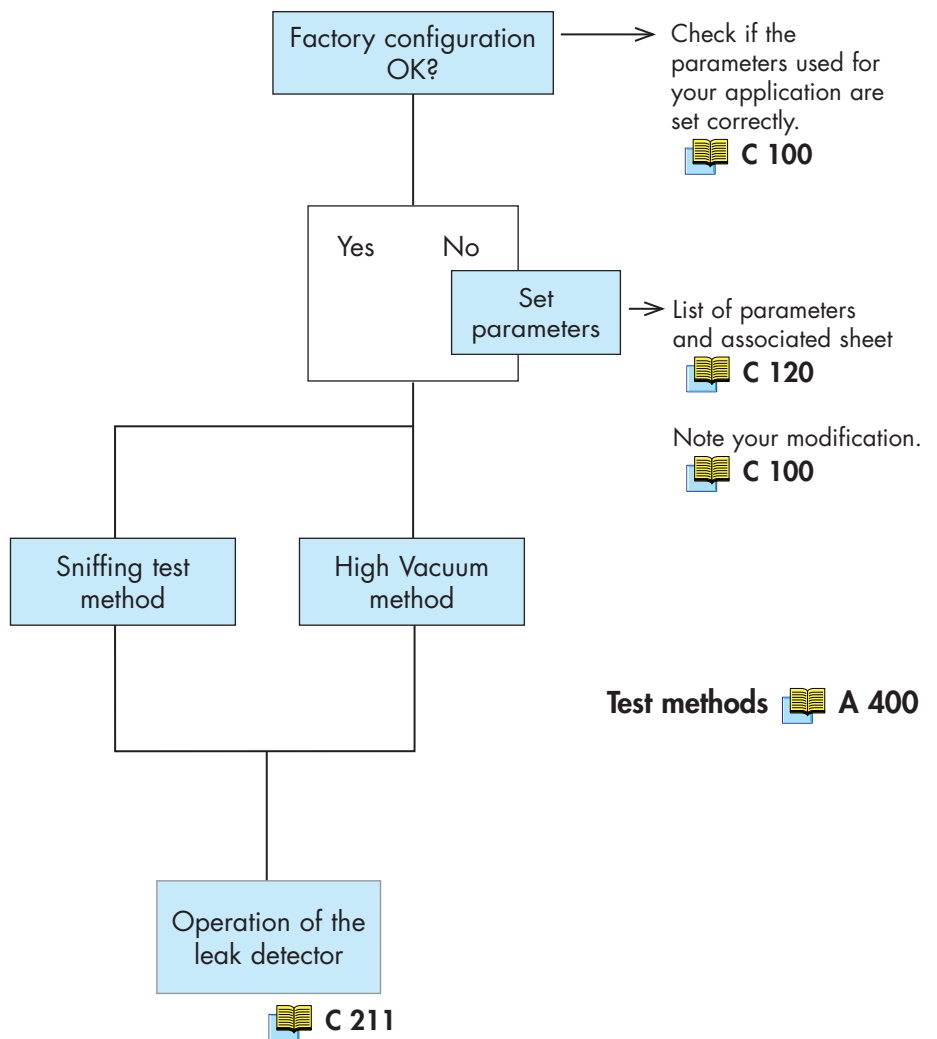

How to use the leak detector: 2 methods

Hard vacuum test method

- Hard vacuum test method offers 2 or 3 test modes: the Gross Leak, the Normal and the High Sensitivity mode. The leak detector will automatically go from the gross leak to the superior mode as soon as the inlet pressure has crossed the thresholds:

	Gross leak test mode	Normal test mode	High Sensitivity test mode
ASM 182 T	Inlet pressure < 6 mbar	----	Inlet pressure < 2×10^{-2} mbar
ASM 182 TD+	Inlet pressure < 6 mbar	----	Inlet pressure < 2×10^{-2} mbar
ASM 192 T	Inlet pressure < 6 mbar	----	Inlet pressure < 2×10^{-2} mbar
ASM 192 TD+	Inlet pressure < 6 mbar	----	Inlet pressure < 2×10^{-2} mbar
ASM 192 T2	Inlet pressure < 6 mbar	----	Inlet pressure < 2×10^{-2} mbar
ASM 192 T2D+	Inlet pressure < 30 mbar	Inlet pressure < 3 mbar	Inlet pressure < 2×10^{-2} mbar
ASM 142	Inlet pressure < 10 mbar	Inlet pressure < 5×10^{-1} mbar	----
ASM 142 D ASM Graph D+	Inlet pressure < 10 mbar	Inlet pressure < 5×10^{-1} mbar	----
ASM 122 D	Inlet pressure < 20 mbar	Inlet pressure < 2 mbar	Inlet pressure < 8×10^{-3} mbar

A hard vacuum test can be performed as soon as one of the test modes is reached.

Test mode selection

Factory configuration

Procedure

 C 100

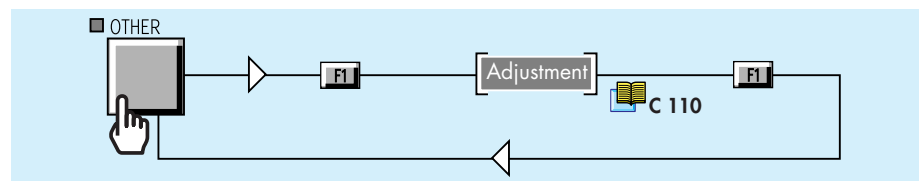

Notes

- The leak detector will switch test mode if the inlet pressure is under the normal test mode threshold.
- When the leak detector is in the selected test mode, a «->» sign is displayed on the screen.
- If the gross leak test mode is selected, the leak detector will remain in the gross leak test mode even if the inlet pressure is compatible with the normal test mode threshold.
- If the pressure is superior to 10^{-4} mbar, it's not possible to reach the normal or high sensitivity test mode  C 560.

How to use the leak detector: 2 methods

Special Service test mode

According to the leak detector model, 2 or 3 test modes are proposed. A 3th or 4th test mode is now proposed for the service people: roughing test mode. It allows to keep the leak detector in roughing after a cycle start in order, by example, to measure with an external gauge the ultimate pressure of the roughing group.

Access to the Special Service Menus:  E 230



```
PRESSURE UNIT : mbar  
ZERO ROUGHING : yes  
TEST MODE : roughing  
START TEMPO : 00:10
```

Sniffing test method

- The leak detector measures a leak value which is displayed on the user interface.
- The test method used is the sniffer method.

Operation of the leak detector

Hard vacuum test



Make sure that parts can withstand the difference in internal / external pressure to which they are submitted.

Starting a test cycle

■ Connect the part or the installation to be tested to the inlet port of the leak detector or put the part in the test chamber.

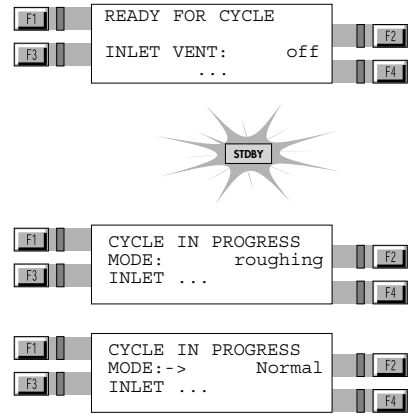
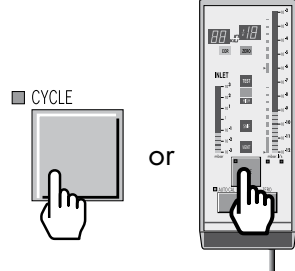

The leak detector reaches test mode selection. C 210

The leak value is displayed on the screen.

Leak value display

• On the operator interface:

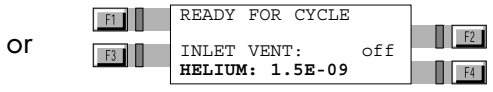
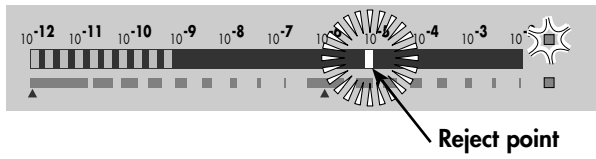

The helium signal zero scale displays the leak value in 2 colors following the measured leak value:

- the reject point is display with a red led.
- if the measured leak value exceeds the reject point, the flashed leds are red (and the blinking led orange).
- if the measured leak value is under the reject point, the flashed leds are green,

Operation of the leak detector

Leak value display • On the remote control:

Digital display



Analog display

When the bargraph zoom is ON, the leak value display is different. It shows 2 decades of signal as compare to the entire leak range when the bargraph zoom is off.

C 510

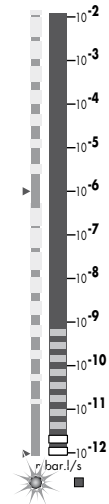

Ending a test cycle

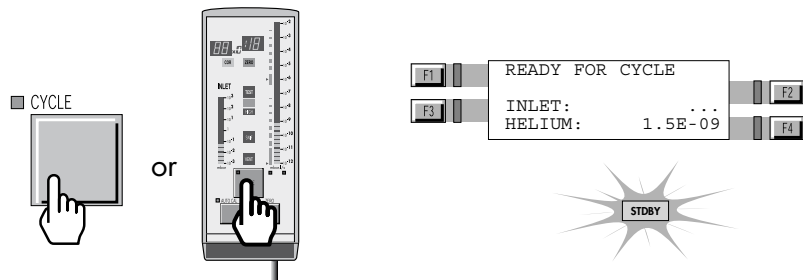

- In standby mode the user interface shows the leak detector helium background value.
- Note: If the cycle end function is activated, the test cycle end is different.

Cycle end function C 530

Ticket If memo function activated, and a printer connected to the leak detector, a result ticket is printed automatically:

example 6 B 320.

Venting the part or installation tested

- At the end of a test cycle, 2 possibilities are available:
- venting (inlet of the leak detector is back to atmospheric pressure)
 - not venting (keeping under vacuum) the part or tested installation tested remains under vacuum.

Inlet vent C 500

Operation of the leak detector

Sniffing test

Starting a sniffing test

While the leak detector is in stand-by mode, connect the sniffer probe (accessory to be purchased separately  **A 700**) to the sniffer port of the leak detector.

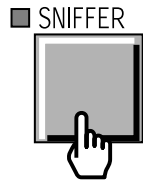

The sniffing mode message appears on the alphanumeric display.
The sniffing test mode is operational.

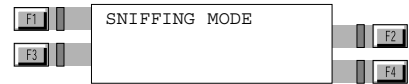
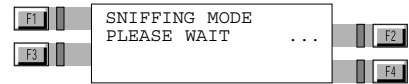
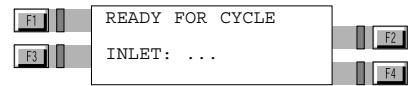

Leak value display

Displays are the same in hard vacuum and sniffing test modes. Please refer to hard vacuum test mode for the displays.

Ending a sniffing test

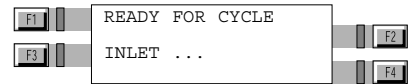

Sniffer probe clogged reject point

Accessories  **A 700**

Advice

Block the sniffer probe end from time to time with a finger to check that the helium signal goes down. If not, the probe may be clogged.

Sniffer probe clogged  **G 200**

Operation of the leak detector

Purpose of the sniffer probe clogged reject point

When the helium signal is lower than the set «sniffer probe clogged» reject point, an information will be activated.

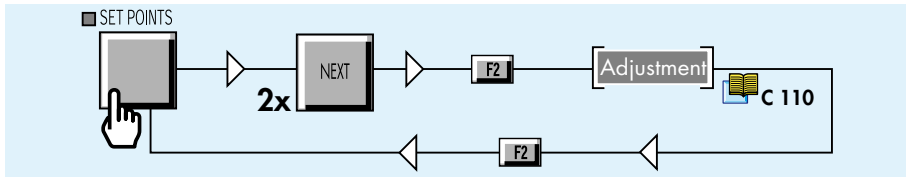

Adjust vacuum/sniffing alarm reject point

Note: Adjustment process is different depending on user interface level of the operator:

For operator with user interface **level 1** or **2**: access to level **4** with password.

To access to level **4** C 130

Procedure with user level 3

3

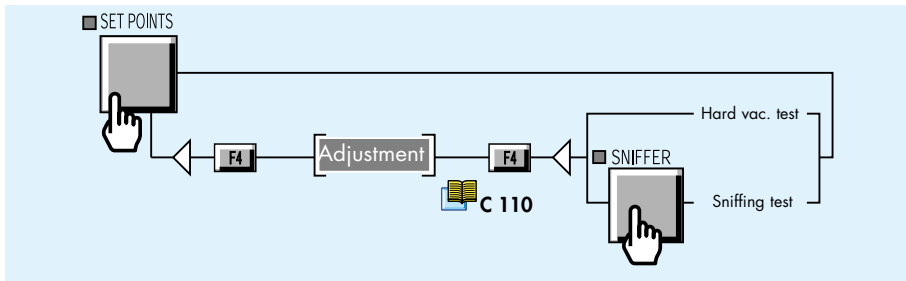





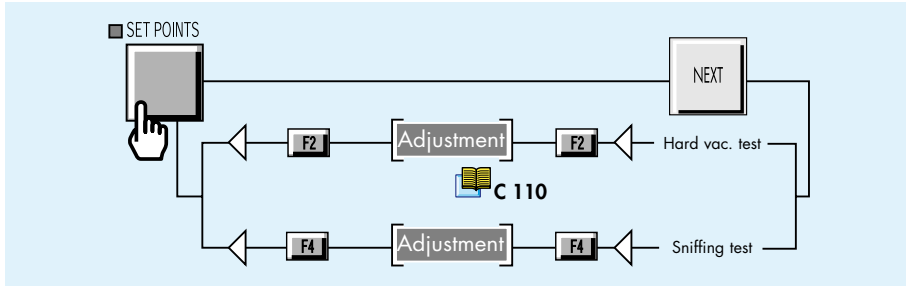







Procedure with user level 4

4



The unit selection of the leak detector is the threshold unit. If the operator would like to change unit, he must convert the threshold unit and reprogrammed it with the new one.

Calibration of the leak detector

- Basic internal calibration of the leak detector  **C 301** 
- Advanced internal calibration of the leak detector  **C 302** 
- External calibration of the leak detector  **C 303** 
- Correction factor  **C 304** 
- Calibrated leak values programming  **C 305** 
- Adaptator for calibrated leak  **C 306** 

Basic internal calibration of the leak detector

Purpose of the internal calibration

Check that the leak detector is correctly adjusted to detect the carrier gas selected and to display a correct leak value.
To calibrate the leak detector, a calibrated leak is used as a reference: the leak detector is equipped with an internal helium calibrated leak with reservoir and temperature compensation sensor.

The internal calibration could be:

- fully automatic if the operator uses the calibrated leak in the detector,
- semi-automatic if the operator uses an external calibrated leak.

When should an internal calibration be performed?

- When starting the leak detector in order to make sure that it is in proper operating condition.
- For high sensitivity test and optimized measurement accuracy: it is advised to let the internal temperature of the leak detector stabilize for about 30 min after start-up and then start a calibration.
- If in doubt regarding the proper operation of the leak detector (capability to properly detect a helium leakage). At any time, an internal calibration may be started.
- In case of intensive and continuous use: start an internal calibration at the beginning of each shift (8 hours of operation).

Internal calibrated leak



The internal calibrated leak is specifically designed to fit the present leak detector. It is composed of:

- a helium reservoir,
- a temperature sensor (used to take into account the effect of temperature on the leak rate),
- a built in membrane (to calibrate the helium leak rate),
- a special quick connection device,
- an identification label (similar to the identification label of an external calibrated leak).

It is delivered with a calibration certificate.

Calibrated leak location  F 700

Recalibration

It is recommended to have each calibrated leak recalibrated at regular intervals to validate its value.

Accessories  A 700

Basic internal calibration of the leak detector

Internal calibration with the internal He calibrated leak

The internal calibration can be:

- fully automatic:



The internal calibration is **automatically activated** during the start-up process of the leak detector. It does not require any operator action. The initial calibration during the start-up sequence allows the unit to be immediately operational.

- on operator request:

An internal calibration can be started by the operator **whenever the leak detector is not in test mode.**

If the detector has been calibrated with an external calibrated leak, the operator should store the values of the internal calibrated leak  **B 320.**

Tickets

If a printer is connected to the leak detector, a ticket is automatically printed at the end of the calibration: example   **B 320.**

Automatic internal calibration procedure

Note: Internal auto-calibration set ON,  **C 302.**

- Start the leak detector

Different screens appear during the calibration giving internal parameters values.

Audio messages inform the operator about internal calibration process during this one.

When calibration is complete, the unit is ready to start a cycle.

The digital voice gives to the operator the message "Detector ready for cycle".

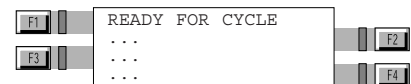

Note:

- It is possible to start a test cycle after a calibration failure: The operator should confirm the use of an uncalibrated leak detector.

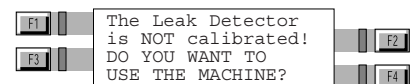

- The test is still possible but "AL" is displayed permanently (no value displayed). The bargraph is always available for the leak value reading.

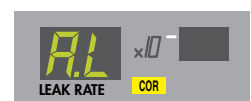

- Until the autocalibration failure is resolved, the "!" is maintained on the standby screen.

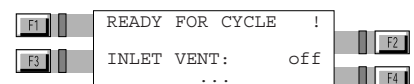

Basic internal calibration of the leak detector

On request internal calibration procedure

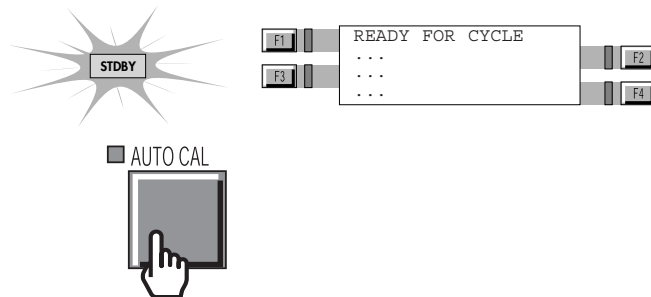

Then, the procedure is the same as for the automatic internal calibration.

On request calibration checking





Internal calibration with an external calibrated leak

It is semi-automatic because the operator must connect a calibrated leak to the inlet port of the detector.

- At the starting of the detector:
The calibration is not start even if the autocal is ON. The operator is informed that the calibration requests a calibrated leak connected to the inlet port of the detector.
- On operator request:
The operator can start a calibration **whenever the leak detector is not in test mode.**
Note: Internal calibration set ON.

Tickets

If a printer is connected to the leak detector, a ticket is automatically printed at the end of the calibration: example   **B 320.**

Procedure

- 1 Gas selection** In standard the gas used is the Helium 4. With the 3 masses option, the operator can use different gases: Helium 3, Helium 4 or Hydrogen.

3 masses option  **C 430**

- 2 Calibrated leak parameters** The operator should program all the parameters of the used calibrated leak.

Position = external

Calibrated leak value  **C 305**

Basic internal calibration of the leak detector

3 Start the calibration

- Place the external calibrated leak on the test port.
- Start the calibration.



4 Calibration preparation

These 2 screens appear alternately.

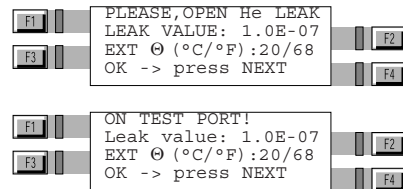

Note: If the operator press , all the parameter of the programmed calibrated leak are displayed.  **C 305**

Open the valve of the calibrated leak (if there is one).

Set the ambient temperature.



 **C 110**

5 Validate the calibration process



Different screens appear during the process giving internal parameters values.

Basic internal calibration of the leak detector

6 End of the process

Close the valve of the calibrated leak (if there is one).

These 2 screens appear alternately.

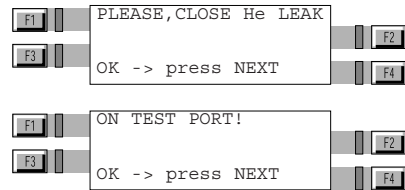

Validate the operation.



Note: If these operations are not done within a minute after these screens display, the calibration is automatically stopped. A message informs the operator of this stop.

When the calibration is complete, the unit is ready to start a cycle.

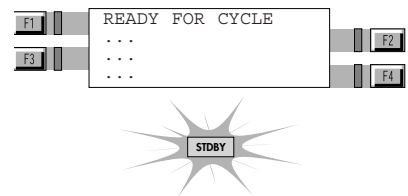

Note: it is possible to start a test cycle after a calibration failure.

Advanced internal calibration of the leak detector

A help for control panel utilization/access.

Operating principle of the control panel



C 110

Setting and maintenance part presentation of the control panel



C 120

Access to parameters and parameters active depending on authorization

Access to level 4 - Password



C 130

Summary of screens

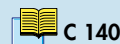

C 140

Complete displays list with access way and associated sheet

Introduction

The operator has the possibility to control on the internal calibration process:

- activation / deactivation of the internal calibration.
- setting of the checking function.

Activation/ deactivation of the internal calibration

For maintenance for example.

Procedure

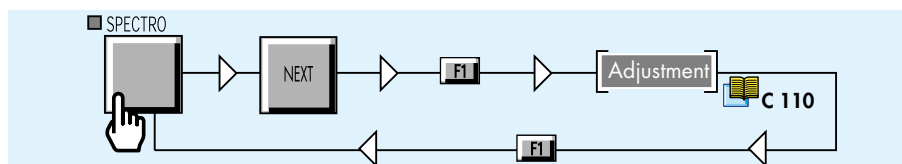

Notes:

- If the internal calibration is deactivated (off), it is still possible to start a test cycle and use the leak detector.
- When internal calibration function is activated (on), user could activate or not activate the checking function.

Advanced internal calibration of the leak detector

Checking function Internal calibration activated (on), checking function performs a calibration checking depending on set parameters. The calibration checking is performed with the internal calibrated leak of the leak detector (position parameter = internal). **C 305**

On request calibration checking At any time, the operator could perform a calibration checking with the internal calibrated leak.

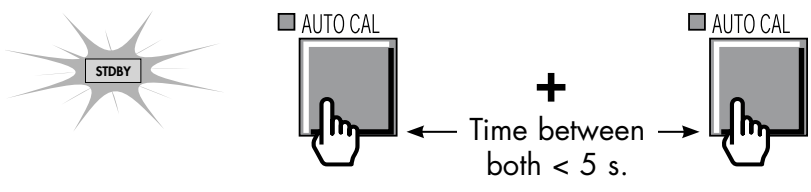

The leak detector compares the signal delivered by the internal calibrated leak to the internal calibrated leak parameters set:

- if the difference is lower than 15 %, the calibration of the leak detector is OK.
- if the difference is higher than 15 %, there is a warning message which requests to perform a complete calibration of the leak detector.

C 301

Parameters setting

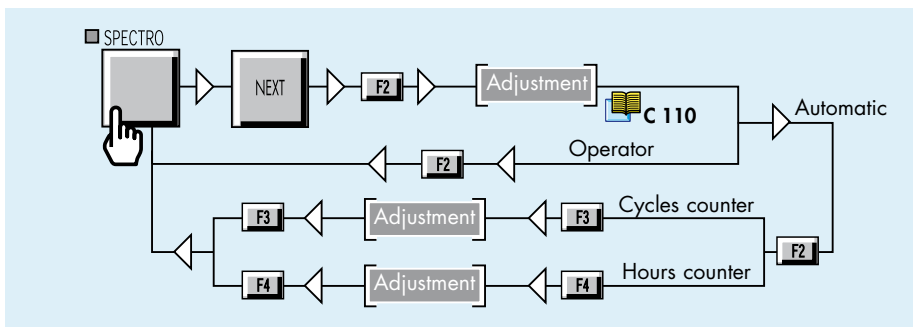

If checking function is automatic, operator should adjust cycles and hours counters which will trigger the automatic calibration checking.

Note: The first of the 2 counters reached will trigger the automatic checking.

Tickets If a printer is connected to the leak detector, a ticket is automatically printed at the end of the calibration: example **B 320**

Advanced internal calibration of the leak detector

Checking function with an external calibrated leak

It is possible to perform a calibration checking with an external calibrated leak (position parameter = external). But it is not automatic and in the case, the leak detector performs a complete calibration (not only a comparison like with the internal calibrated leak).

When the first of the 2 counters is reached, a "i" will flash at the right end of the 1st line of the LCD.

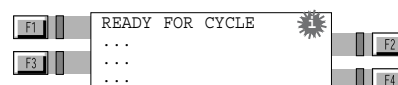

The "i" flashing will stay on the LCD until operator starts an external calibration.  **C 303**

An audio message advises the operator in the process to follow.

Note: It is still possible to start a test cycle even without performing an internal calibration .

On request calibration checking

 **C 301**

External calibration of the leak detector

A help for control panel utilization/access.

Operating principle of the control panel



C 110

Setting and maintenance part presentation of the control panel

Access to parameters and parameters active depending on authorization



C 120

Access to level - Password



C 130

Summary of screens

Complete displays list with access way and associated sheet



C 140

Purpose of the external calibration

In some instances, it may be convenient to display a helium leak value so that matches a desired target value (typically the value of an external calibrated leak connected to the installation to test or at the inlet port of the leak detector):

- **In hard vacuum test mode**

When the measurement range is very different from the value of the internal calibrated leak.

- **In sniffing test mode**

When a specific calibration is required in the sniffing test mode to certify that the measurement is validated and accurated.

- **In hard vacuum or sniffing test mode**

When the leak detector is connected to an installation having its own pumping system in operation and a small amount of the leak goes into the leak detector. The external calibration allows to get a direct readout of the current leak value.

When the helium signal needs to be displayed in a different unit for convenience or to calibrate the leak detector if the internal calibrated leak is temporarily unavailable (manual auto-calibration selected).

The external calibration is provided for the operator to easily obtain a direct readout of the target value (or current external leak) thanks to a correction factor automatically calculated and applied to the digital display of the leak detector.

Note : For the ASI 22, the pressure measurement kit is necessary to do an external calibration ( **A 700**).

External calibration of the leak detector

External calibrated leak

An external calibrated leak (defined in accordance to your own requirements) is required for the external calibration procedure.

Accessories  A 700

Recalibration

It is recommended to have each calibrated leak recalibrated at regular intervals to validate its value.

Tables of preventive maintenance intervals  D 100

Digital and analog display

When the external calibration is performed, the digital display will show a corrected value. Then  will come on to reflect it. The analog display in the remote control is not corrected and therefore both values might be different.

External calibration procedure

The external calibration should only be performed when the leak detector is already internally calibrated.

The external calibration procedure is performed in 2 steps:

- 1st step: selection of the test mode (hard vacuum or sniffing)
- 2nd step: adjustment of the target value: see below.

External calibration cancellation

At any time, the operator can cancel external calibration procedure.

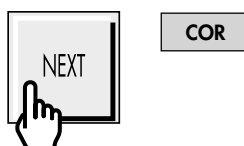

Procedure

Note: The external calibration should be performed in the test mode used by the operator: if the operator uses both test modes (hard vacuum and sniffing), he should perform one external calibration when he works in each test mode.

The external calibrated leak is connected to the inlet port of the leak detector or at a suitable location of the installation to test.

Réglage des paramètres de la fuite calibrée externe  C 305

External calibration of the leak detector

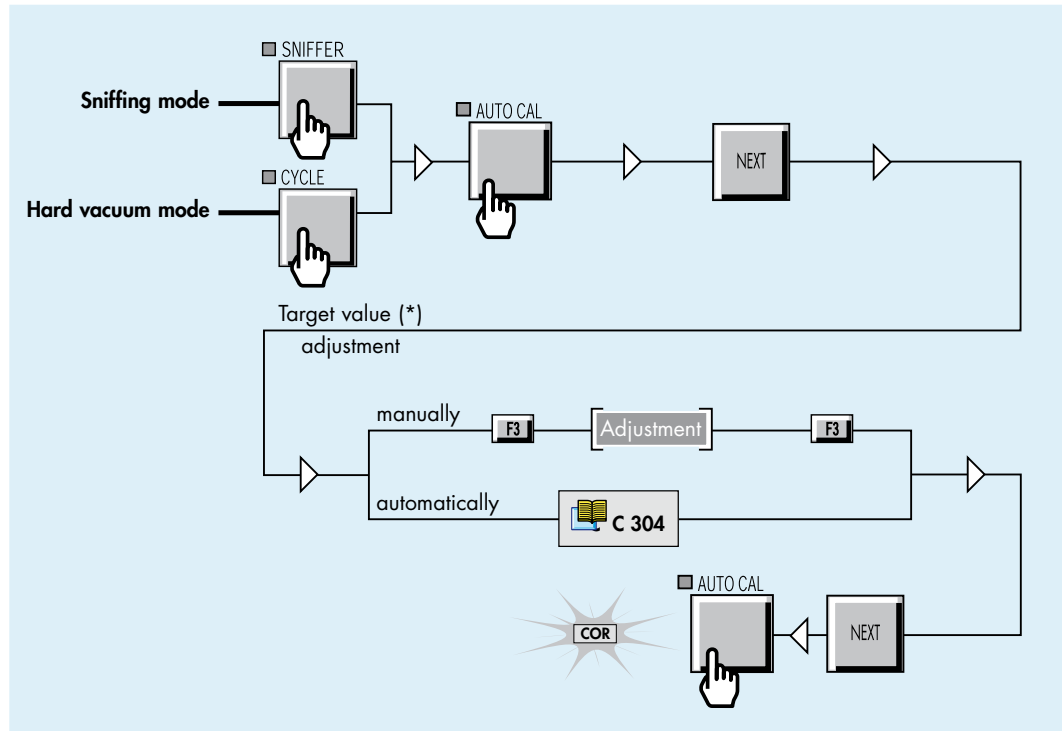

(*) The target value is the desired value to be displayed on the digital display at the end of the calibration..

The target value can be memorized following 2 methods:

- the operator enters directly the target value,
- the target value is automatically calculated by the leak detector.

About sniffing test mode

In sniffing test mode, the calibration can be performed with:

- the ambient atmosphere,
- an external calibrated leak,
- a container or installation, at atmospheric pressure, filled with a known gas mixture including Helium.

The sniffer probe will be exposed to one of the 3 items listed above (3rd one represents the most reliable and accurate way of calibrating a leak detector in sniffing mode).

The 1st and 2nd ones are the most common and practical methods.

Before using one of the 2 items, connect the sniffer probe to the sniffer port of the leak detector.



External calibration of the leak detector

Target value determination

- In hard vacuum test mode, 1 possible case:
 - The target value is the value of an external calibrated leak connected to the installation to test or at the inlet port of the leak detector.
 - **Case A**
- In sniffing test mode, 2 possible cases:
 - the target value is the value of an external calibrated leak.
 - **Case A**
 - If a container or installation is filled with a known gas mixture including Helium, it is possible to enter helium concentration as a target value. → **Case B**

Case A

When an external calibrated leak is used, it is recommended to take into account date of calibration and temperature effect for calculating the target value from the calibrated leak value as shown on its identification label.



HELIUM CALIBRATED LEAK
 Helium leak rate : 1.0×10^{-8} mbar.l/s at 20 °C
 Date of calibration : 10 Dec 2001
 % loss per year : 2 %
 % increase per °C : 3 %

Example of calibrated leak label indications (as listed here):
 If the date is 1st Dec 2003 (about 2 years after calibration) and calibrated leak (ambient) temperature is 25 °C:
 Target value = $1.0 \times 10^{-8} \times [1 + 0.03 \times (25 - 20)] \times [1 - (0.02 \times 2)]$
 = 1.1×10^{-8} mbar.l/s

Case B

Reminder: 1 PPM = 1.0×10^{-6} (concentration)

Example : container with 100 PPM helium mixture.

2 possibilities :

- enter target value = 0 E+02 to display the test result in PPM
- enter target value = 1.0 E-04 to display the test result in helium concentration
 (100 PPM = $100 \times 10^{-6} = 1 \times 10^{-4}$)

Checking function with an external calibrated leak

Correction factor

A help for control panel utilization/access.	
Operating principle of the control panel Setting and maintenance part presentation of the control panel Access to parameters and parameters active depending on authorization	C 110 C 120
Access to level 4 - Password Summary of screens Complete displays list with access way and associated sheet	C 130 C 140

Definition The correction factor is used to display the helium signal (changing unit for example).

The correction factors applied to the digital display with respect to the external calibration are:

- VACUUM COR in gross leak test mode,
- SNIF COR in sniffing test mode.

The VACUUM/SNIF COR values are automatically adjusted according to helium signal fluctuations. These correction factors are memorized until another external calibration is validated.

They can be activated, deactivated or modified.

The correction factors are automatically calculated by the external calibration but it is also possible to enter them manually C 303

Activate/Deactivate the correction factor VACUUM/SNIF COR Adjustment

There are 2 possible procedures depending on which authorized level: level 3 and 4.

Procedure with user level 3

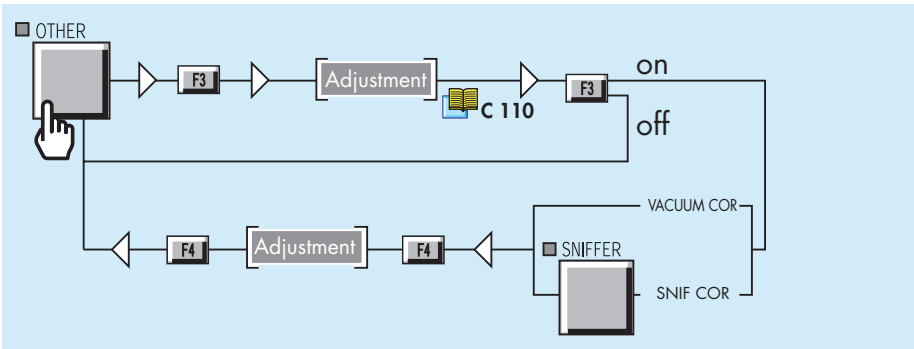

Correction factor

Procedure with user level

4

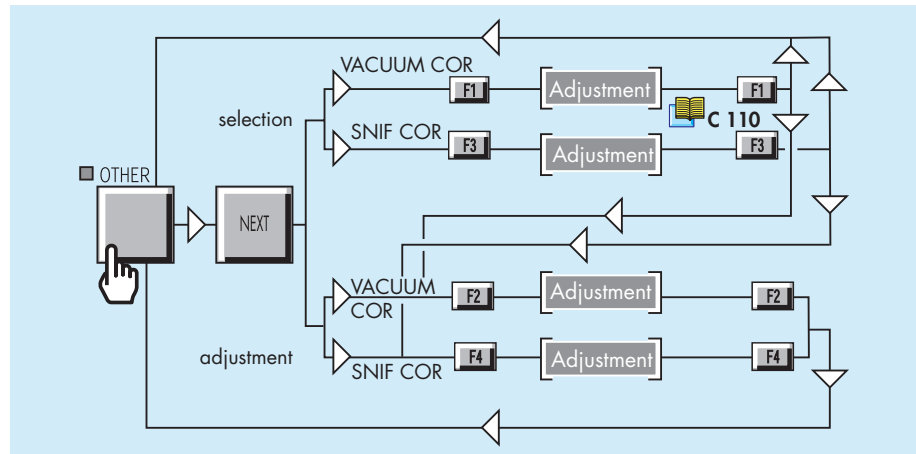

General notes (in vacuum or sniffing test mode)

- During the external calibration process:

$$\text{basic digital display} \times \text{VACUUM/SNIF COR} = \text{target value}$$

Basic digital display is the helium signal basic display without correction ratio (as if COR indicator is OFF or VACUUM/SNIF COR equal to 1.00E-00).

- Once the external calibration correction is validated, the digital display is modified:

$$\text{corrected digital display} = \text{basic digital display} \times \text{VACUUM/SNIF COR}$$

The analog display (standard scale) always displays the basic value of the helium signal which is not modified by VACUUM/SNIF COR.

- During the last step of the external calibration, the VACUUM/SNIF COR is displayed and automatically calculated with respect to the fixed target value and the present basic signal value. The VACUUM/SNIF COR ratio is fixed and memorized when the AUTOCAL key is pressed to confirm the CORRECTION and stop the external calibration process.
- The COR indicator is ON as soon as the VACUUM/SNIF COR is ON and different from 1.00E-00. If the target value is the same value as the standard signal on the digital display, in other word if VACUUM/SNIF COR is equal to 1.00E+00, the COR indicator is automatically OFF: the external calibration is OFF.
- If RESET is pressed during or at the last step of the external calibration process, the leak detector comes back to the previous digital display status which was effective before the external calibration request and VACUUM/SNIF COR is not changed.

Calibrated leak values programming

A help for control panel utilization/access.

Operating principle of the control panel



Setting and maintenance part presentation of the control panel



Access to parameters and parameters active depending on authorization

Access to level  - Password



Summary of screens

Complete displays list with access way and associated sheet



Different types of calibrated leaks

Before to start an internal calibration of the leak detector (with internal or external calibrated leak), the parameters of the calibrated leak used should be programmed by the operator.

The leak detector can be calibrated:

- with an internal or external calibrated leak
- with different gases (Hydrogen and Helium 3) if it is equipped with the 3 masses option.

3 masses option  **C 430**

Gas	Internal calibration	External calibration
Helium 4	X	X
Helium 3	-	X
Hydrogen	-	X

Whatever the type of calibrated leak used, the parameters to program are the same.

Calibrated leak values programming

Programming the calibrated leak parameters

This operation can be made with the data written on the calibrated leak identification label or the calibration certificate delivered with it. Example of identification label:

HELIUM CALIBRATED LEAK
 Helium leak rate : 1.0×10^{-8} mbar.l/s at 20 °C
 Date of calibration : 10 Dec 2001
 % loss per year : 2 %
 % increase per °C : 3 %

Note: At each time the operator modify the "Location" parameter, he should also re-adjust all the parameters (if necessary).

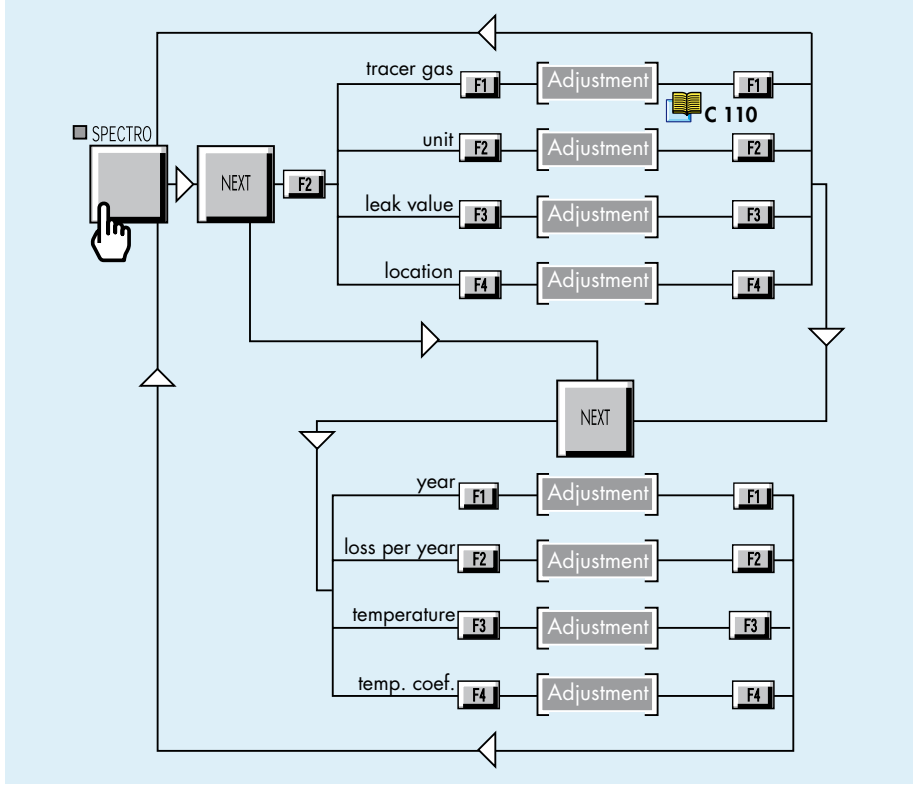

Leak location selection

Note: The "Location" parameter (internal or external) concerned the location of the calibrated leak used for the calibration and not the type of calibration.

Adaptor for calibrated leak in sniffing mode

An adaptor DN 16 or DN 25 for calibrated leak has been designed for the calibration of the detector with an external calibrated leak.

Accessories  A 700



How to use the adaptor ?

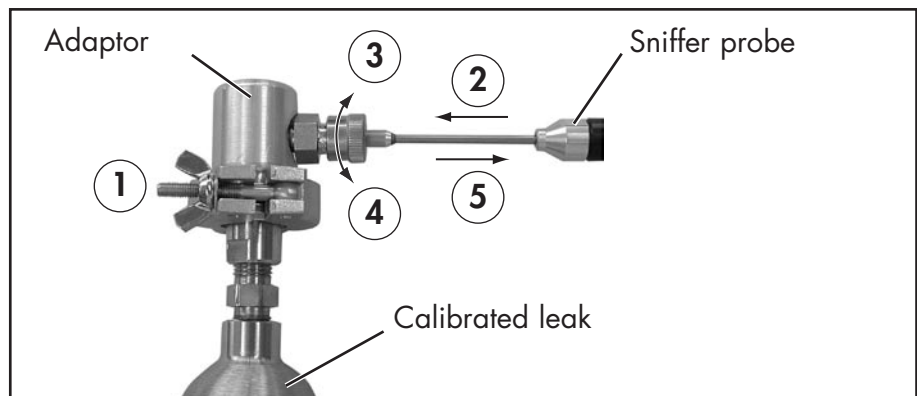

- 1 Place the adaptor to your calibrated leak used for the calibration.

Start a calibration

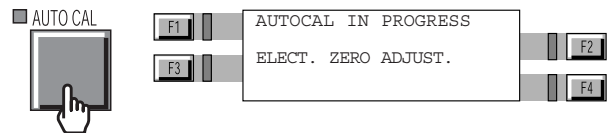

- 2 Place the sniffer probe in the calibration port.

- 3 Tighten the fixing screw. Follow the auto-calibration.

Calibration of the leak detector  C 300

- 4 Untighten the fixing screw.

- 5 Remove the sniffer probe of the calibration port. Follow the auto-calibration.

Notes

- Waiting 10 s (mini) for the signal stabilization before reading of the leak value.

- The leak value displayed on the LCD consider the He of the air.

Example : calibration with a leak of 2×10^{-5} mbar.l/s

The value displayed is:

$$2 \times 10^{-5} + 5 \times 10^{-6} = 2.5 \times 10^{-5} \text{ mbar.l/s}$$

Remote control



The remote control is an accessory, but it could be also an option depending on the helium leak detector model.

The remote control is equipped with a magnet allowing the operator to place it on a metallic surface. The operator can read the helium signal and has access to control keys such as cycle command autocalibration and auto-zero.

Remote control interface

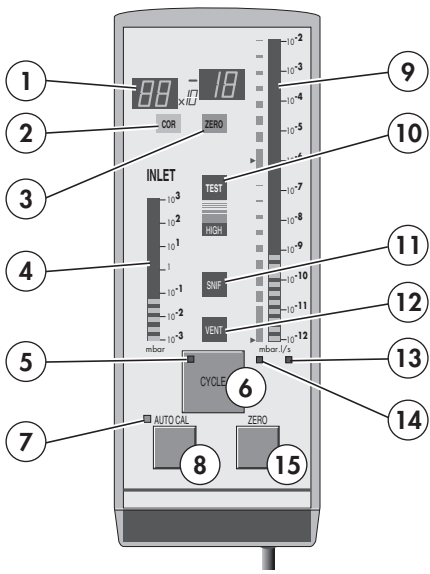

	142 range - 182/192 range ASM 122 D - ASM 1002	ASI 22
--	---	--------

1	Helium Signal digital display	✓	✓
2	Correction factor COR indicator	✓	✓
3	Zero function indicator	✓	✓
4	Inlet port pressure analog display	✓	✓(1)
5	Test cycle ON indicator (ON when activated)	✓	✓
6	Cycle Start/Stop control key	✓	✓
7	Calibration in progress indicator	✓	✓
8	Auto-calibration start control key	✓	✓
9	Helium signal analogic display	✓	✓
10	Test ON indicator	✓	✓
11	Sniffing test mode ON indicator	✓	✓
12	Inlet VENT ON indicator	✓	-
13	Helium signal standard scale ON indicator	✓	✓
14	Helium signal Zero scale ON indicator	✓	✓
15	Zero ON/OFF control key	✓	✓

(1) If the pressure measurement kit is installed

Remote control

Remote control connecting

In order to use the remote control with control panel with graphic interface, it is necessary to connect the remote control before starting up the detector.

Location and connecting  B 210

Remote control choice

3 different units could be selected in the leak detector but only one unit is available on the remote control. So the operator should choice its remote control in accordance of the operation unit chosen.

Unit  C 570

Accessories  A 700

When the operator connects the remote control on the leak detector, the leak detector unit is automatically reprogrammed with the unit of the remote control. The remote control unit is memorized by the detector when the operator disconnects the remote control.

Use and display

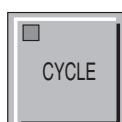

The remote control:

- allows to display leak measured value,
- allows to start/stop cycle, zero function and internal calibration,
- allows to display status of the air inlet vent, sniffing test mode and external calibration,
- doesn't allow to adjust leak detector parameters.

Analog and digital displays

On remote control and control panel, the displayed values on the analog and digital displays are exactly the same.

Operation of the leak detector  C 211

To start/stop a cycle

In order to start/stop a cycle, operator can use either the CYCLE control key on the control panel or remote control.

Display

The LED indicator is ON/OFF when the control key is activated/deactivated.

As soon as the detector is in test, the TEST indicator is ON.

Remote control

Use and display (ctd)

Zero function

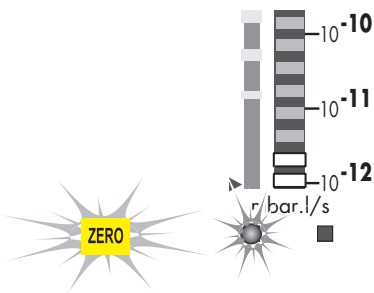

In order to start zero function, operator can use either the ZERO control key on the control panel or remote control.

Display

Two indicators are ON when the zero function is activated:

- the ZERO indicator,
- the zero scale indicator.

Zero function C 540

Internal calibration



In order to start an internal calibration, operator can use either the AUTOCAL control key on the control panel or remote control.

Display

The LED indicator is ON when the control key is activated.

The LED indicator is OFF at the end of the calibration procedure.

Calibration of the leak detector C 300

Inlet vent Sniffing test mode



For these 2 functions, the remote control displays only their status: use the control panel in order to activate/deactivate them..

Display

The LED indicator is ON/OFF when the function is activated/deactivated.

Inlet vent C 500

Sniffing test mode C 211

External calibration



The remote control displays only its status: use the control panel in order to start/stop it.

Display

The LED indicator is blinking when the external calibration is activated.

At the end of the calibration procedure, the LED indicator is OFF and the correction factor COR is ON.

External calibration C 303

Headphone and loudspeaker

The operator can connect a headphone or an external loudspeaker to the detector.

The detector must be equipped with the RS 232 option

Connecting  B 210

Level adjustment

The audio levels for the headphone or the external loudspeaker are the same as for the audio alarm and digital voice functions. In order to adjust the headphone or the external loudspeaker audio levels, you must adjust the levels of the audio alarm and digital voice functions.

Audio alarm / Digital voice  C 520

Accessories ?

Headphone

You should use the headphone connector accessory:

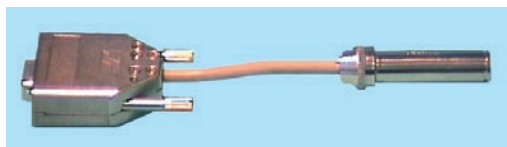

Sub D 9 pins

Jack plug 6.35 mm mono

Accessories  A 700

The manufacturer does not sell headphones. The specifications are:

- Impedance: 400/500 Ω
- Jack plug 6.35 mm (or other sizes with adaptor)
- Frequency band: 18 kHz to 20 kHz

External loudspeaker

The manufacturer does not sell external loudspeaker. The specifications are:

The external loudspeaker has the same characteristics as the internal loudspeaker:

- Impedance: 8 Ω
- Power: 8 W

Headphone and loudspeaker

Configuration The operator can deactivate or not the internal loudspeaker when he uses a headphone.
In the same way, he can deactivate or not the internal loudspeaker when he uses an external loudspeaker.
The functions are selected on the I/O interface board.

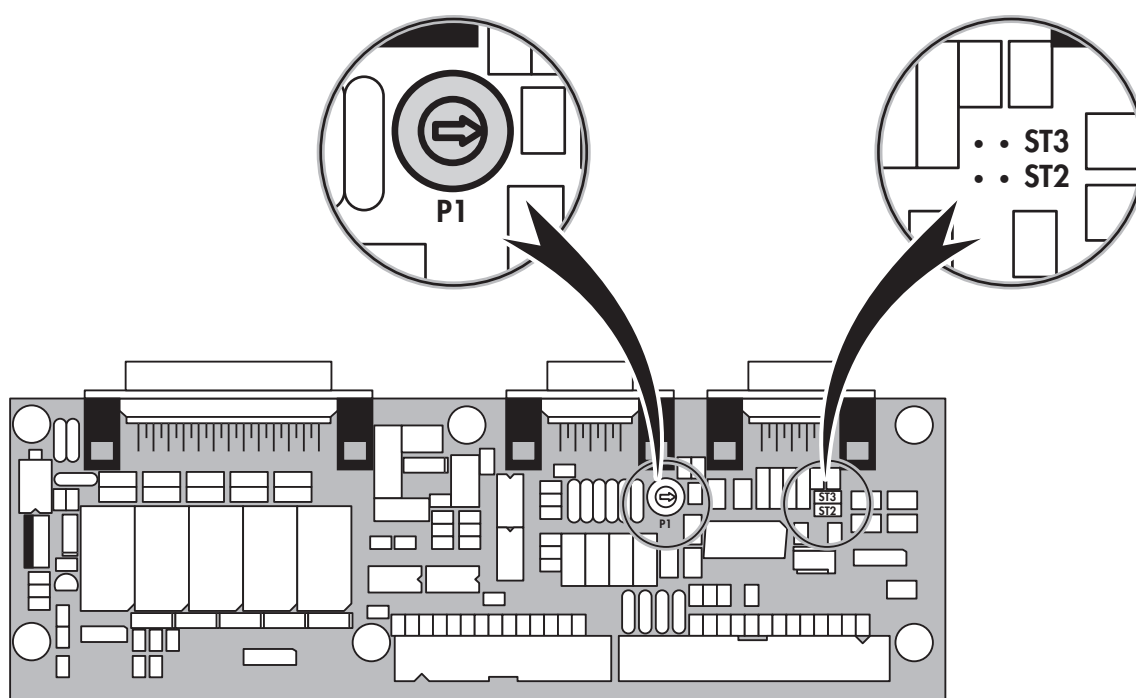







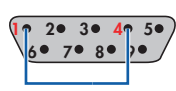

P0307 board

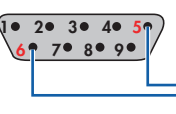
P0307 board localization  F 400

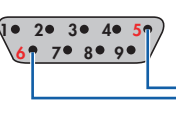
- The operator can adjust the headphone audio level with P1 or with panel control (⊕ and ⊖).

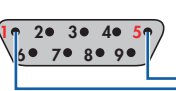
Headphone and loudspeaker

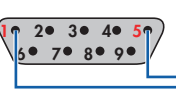
	P0307 board	Strap on ST3/ST2	Sub D 9 pins (printer plug)
Int 	Internal loudspeaker active	<ul style="list-style-type: none"> • ST3 • ST2 	No plug connected
		<ul style="list-style-type: none"> • ST3 • ST2 	
Int  	Internal loudspeaker active + headphone connected	<ul style="list-style-type: none"> • ST3 • ST2 	
Int  	Internal loudspeaker not active + headphone connected	<ul style="list-style-type: none"> • ST3 • ST2 	
Int  Ext 	Internal loudspeaker active + External loudspeaker connected	<ul style="list-style-type: none"> • ST3 • ST2 	
Int  Ext 	Internal loudspeaker not active + External loudspeaker connected	<ul style="list-style-type: none"> • ST3 • ST2 	

3 masses option

Purpose Leak detection is used to detect micro-openings, porosities, etc. in test parts. The detection of these passages involves the use of a light gas, which is capable of infiltrating the smallest passages quickly. The standard gas used is the Helium 4 but the operator has the possibility with the 3 masses option to use another gases: Hydrogen or Helium 3.

Background is much higher in H₂.

The unit equipped with the 3 masses option does not have any external differences in relation to the standard unit. The modifications are inside the unit (analysis cell magnet and electronic supervisor board).

Typical background values, in cycle, detector on itself:

- At start ± low range 10⁻⁵ mbar.l/s.
- After 2 or 3 hours ± low range 10⁻⁶ mbar.l/s.



The 3 masses option purpose, used with Hydrogen, is the leak research only and not the continuous analysis of the hydrogen concentration of a gas.

The leak detector is not adapted for a hydrogen concentration continuous analysis. The leak detector use in such conditions, as well as the hydrogen concentration of the gas used, are under the supervision of the user.

The functions are the same as the standard detector.

Gas selection

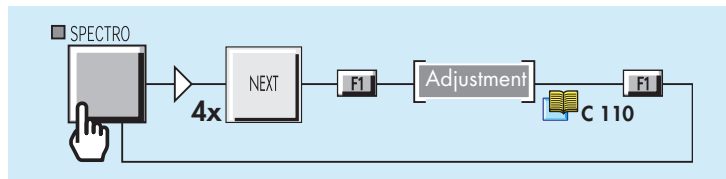

Calibration in Hydrogen or Helium 3

The leak detector can be calibrated in Hydrogen or Helium 3 with an external calibrated leak connected to the leak detector inlet.

Procedure

Connect an Hydrogen or Helium 3 calibrated leak at the inlet of the leak detector.

The operator should adjust the parameters of the calibrated leak used.

Calibrated leak values programming C 305

Calibration of the leak detector C 300

Control panel with graphic interface

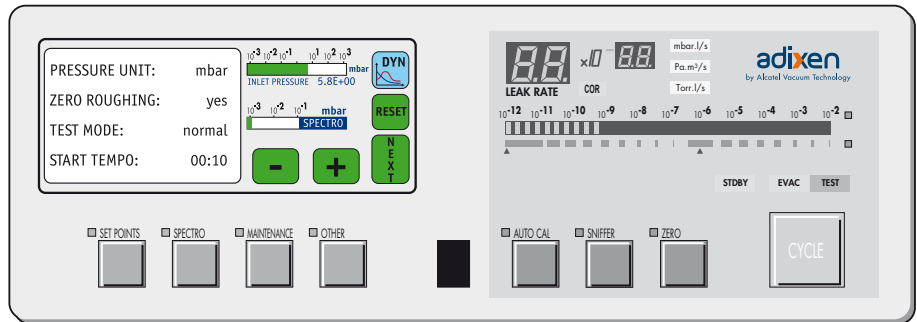

The control panel with graphic interface is equipped with a color touch. In addition to standard panel function, it shows different graphics. This display is offered as an option or as an accessory.

 **A 600/700**

Graphic interface purpose

To display, measure and record the leak detector Helium signal as well as the inlet pressure.

Leak detector software version

It requires a leak detector software version $\geq V3.0r01$ ($\geq V1.0r06$ for ASI 22). Refer to "At the leak detector starting up" paragraph.

Automatic standby screen

If no action is registered through the color touch screen for a period of 1 hour, a standby-screen (black screen) appears automatically. Any press on any key will reactivate the display.

Use caution

- Use a pen, a finger or any other object with a rounded shape on the touch screen.
Don't use a pointed object (screwdriver for example).
- Storage temperature and humidity level.

 **A 800/801**

Control panel with graphic interface

Control panel interface

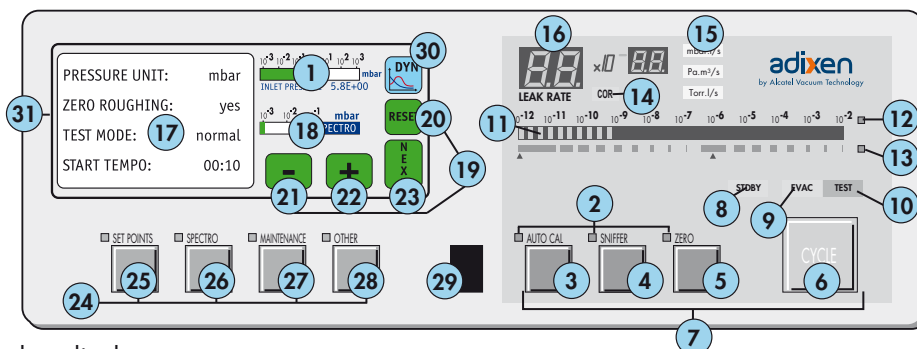

- 1 Inlet port pressure analog display
- 2 Control and menu selection indicators (ON when activated)
- 3 Auto-calibration START/ABORT control key
- 4 Sniffing mode ON/OFF control key
- 5 Auto-zero ON/OFF control key
- 6 Cycle START/STOP control key
- 7 Control keys (4 keys)
- 8 Standby ON/OFF indicator
- 9 Evacuation ON/OFF indicator
- 10 Test ON/OFF indicator
- 11 Helium signal analogic display
- 12 Helium signal analogic scale ON/OFF indicator
- 13 Helium signal Zero scale ON/OFF indicator
- 14 Correction factor COR indicator (applied to digital display)
- 15 Units of measurement selection
- 16 Helium signal digital display
- 17 Menu display (4 lines)
- 18 Spectro pressure analog display
- 19 Modification access keys (4 keys)
- 20 RESET: next display/parameter circular function
- 21 22 Plus or minus value adjustment, parameter selection, audio volume adjustment keys
- 23 NEXT of previously displayed values (cancels temporary inputs)
- 24 Menu selection access keys (4 keys)
- 25 SET POINT menu selection key
- 26 SPECTRO (calibration and analyzer cell configuration menu selection key)
- 27 MAINTENANCE menu selection key
- 28 OTHER menus selection key (test mode selection, inlet VENT selection, date/time)
- 29 Remote control connection (accessory)
- 30 Graphic interface selection key
- 31 Color touch screen

Control panel with graphic interface

Change of interface "Basic" mode

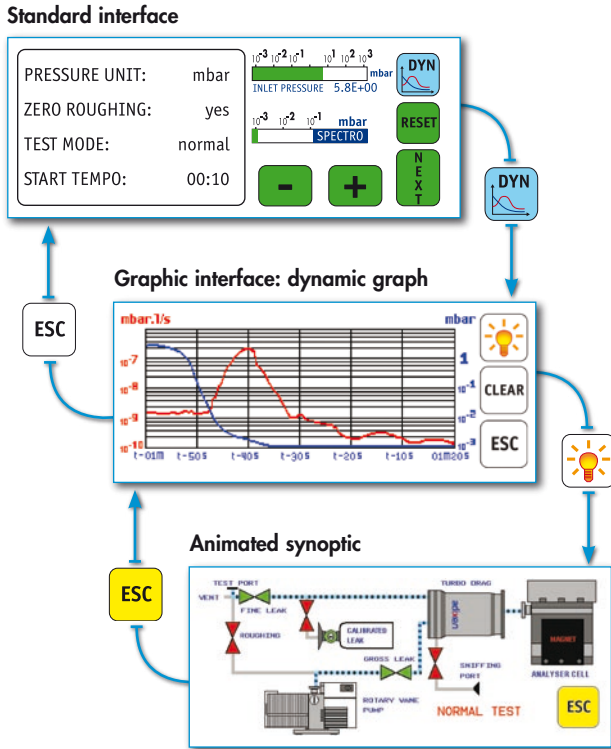

"Advanced" mode

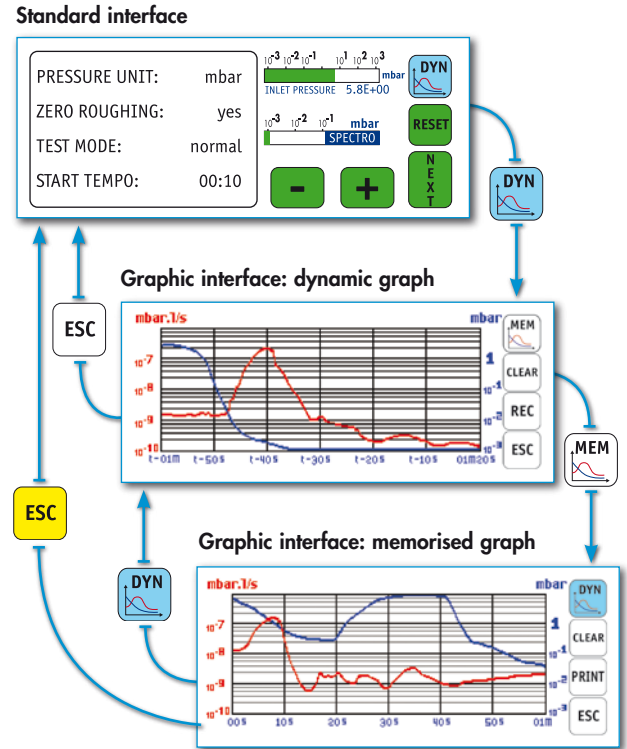

Notes:

- Any action on one of the following keys switches the display back to standard.

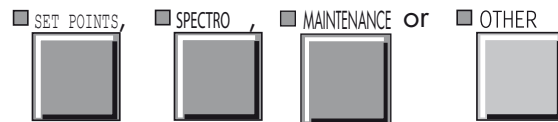

- After repeated zooms or measures in a memorized graph, some display defects could appear when you return to the dynamic graph.

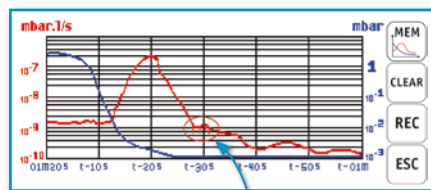

defect example

These defects are unpredictable and no consequence. If a graph is recording, these defects will not be recorded.

Control panel with graphic interface

Operating principle of the standard interface

Please refer to the operating principle of the standard control panel.



Operating principle of the graphic interface

The graphic interface offers 2 operating ("basic" and "advanced") modes.

Dynamic graph

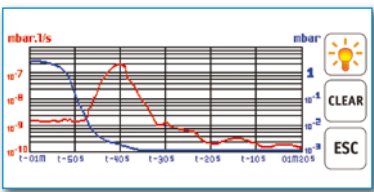

Memorized graph

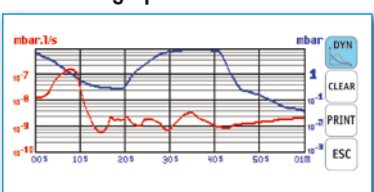

Animated synoptic

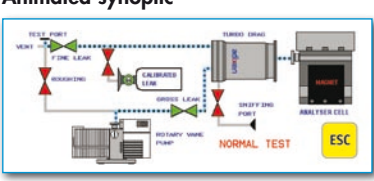

Fonction	"Basic" mode	"Advanced" mode
<ul style="list-style-type: none"> Dynamic graph It shows the helium signal, inlet pressure and reject threshold curves, for a period between 30 s and 4 h, depending on set parameters. It appears by default when we switch from the standard interface to the graphic interface. 	X	X
<ul style="list-style-type: none"> Memorized graph It allows to show the historical of the memorized helium signal, inlet pressure and reject threshold curves, for a period between 3 h 16 mn and 900 h, depending on set parameters. It allows to zoom in on the curves and to measure the signals. 	-	X
<ul style="list-style-type: none"> Vacuum diagram It allows to show the operating principle of the leak detector, its components and the leak detector active parts during the different test phases. The valve colour corresponds at the status (opened / closed) of this valve when the detector is in vacuum test, sniffing test, stand-by or autocalibration. If a valve is manually activated, it will not change of colour on display. 	X	-

Control panel with graphic interface

Selection of the graphic interface use mode

At the leak detector start up

When we switch on the leak detector, the starting screen displays the selected mode.

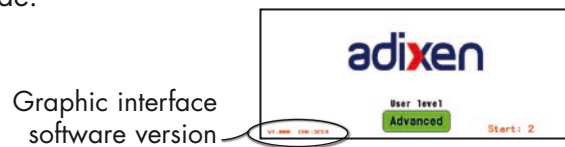

The operator has 6 seconds to change it with a simple press on the key **ADVANCED** or **BASIC**.

During the leak detector use

In order to return to the starting screen, press the following keys at the same time:

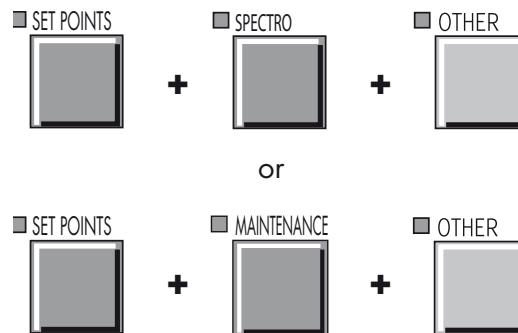

These operations are equivalent to do a complete reset : the dynamic and memorized graphs will be erased.





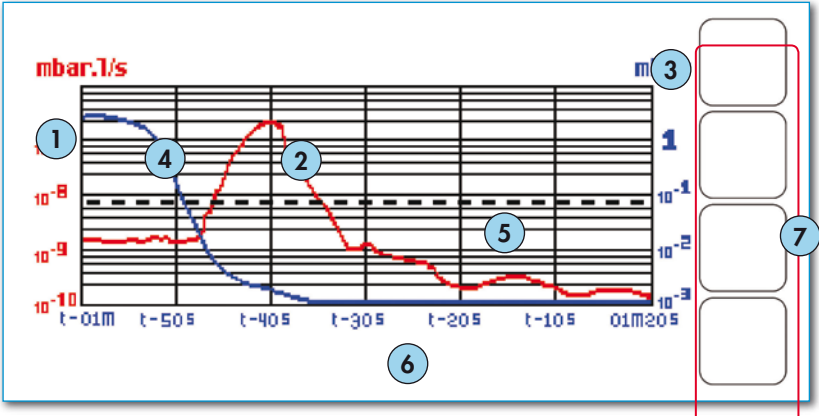











Control panel with graphic interface

Graphic interface description



- ① Helium signal scale
- ② Helium signal (red curve)
- ③ Inlet pressure scale
- ④ Inlet pressure (blue curve)
- ⑤ Reject threshold (black curve)
- ⑥ Time scale
- ⑦ Selection keys: see details below

Selection keys

-  Access to the memorized graph display
-  Access to the dynamic graph display
-  Start recording a graph
-  Stop recording a graph
-   Return to the previous screen or the standard interface
-  Exact value display for a selected point
-  Zoom on the selected area
-  Helium signal curve selection
-  Inlet pressure curve selection
-   Target moving
-  Deletion of the curve displayed on the screen
A message is displayed in order to confirm the operation.
-  Memorized graph recording
-  Access to the leak detector vacuum diagram
-  Contrast adjustment

Control panel with graphic interface

Graphic interface setting

A simple press on the dynamic graph allows access to the setting menu.

Menus description

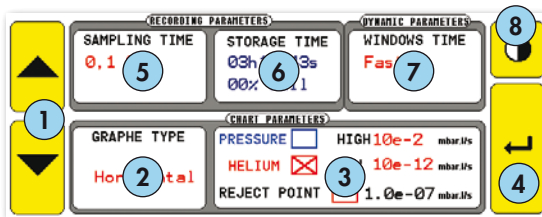

"Advanced" mode

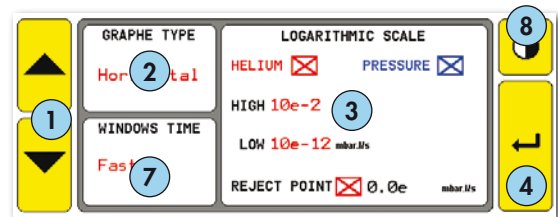

"Basic" mode

- 1 Selected parameter modification
 - 2 Graph type selection : vertical or horizontal
 - Time precision required >horizontal
 - Measure precision and speed required >vertical
 - If we switch from a vertical graph to a horizontal graph, or vice-versa, all the dynamic graph points will be erased.
- example: the same curve with both graph types.

Horizontal

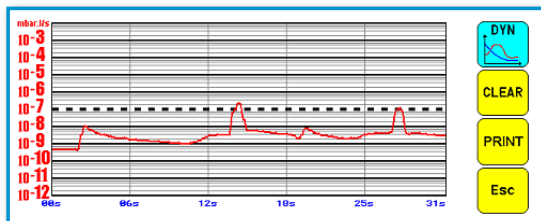

Vertical

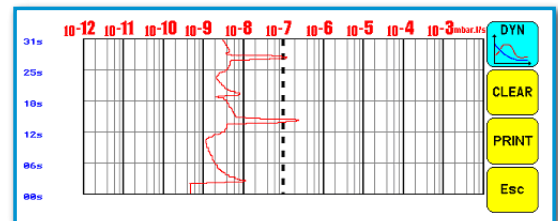

Control panel with graphic interface

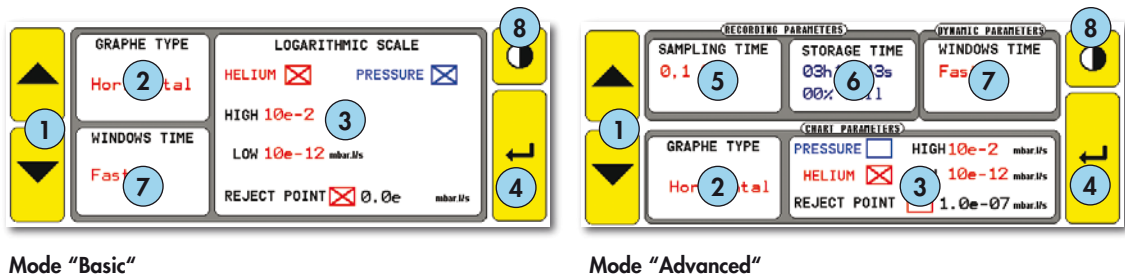

- 3
 - Curves to show/recorder selection with a simple press on the square: inlet pressure (PRESSURE), helium signal (HELIUM) and reject threshold (REJECT POINT).
 - The reject threshold and the unit of measurements in this menu can also be adjusted in the SET POINTS and OTHER menus. Any modification will be applied to the 3 menus (SET POINT, OTHER and graphic interface).
 - Display area setting of the inlet pressure and helium signal curves.
 - If only one curve is selected, the display area applies to this curve.
 - If the both are selected, the display area applies to the helium signal : the inlet pressure display area will be automatically 5 decades higher than the helium signal display area.
- 4 Modification validation or return to the graph.
- 5 Sampling rate between 2 measurements = 2 consecutive points of the memorized curve.
- 6 Maximum recording time possible according to the sampling time set for the memorized graph.
- 7 Time window displayed for the dynamic graph.
 - "fast" represents the maximum signal scrolling speed.
- 8 Adjustment of the contrast.

Contrast adjustment

From the setting menu, you can adjust the screen contrast. Optimum brightness after 5mn switch on. This panel is delivered with an optimum setting of the brightness.

Note: The screen lifetime is the best with a contrast adjusted to 50 %.

- Press on the contrast key 8
- Adjust the contrast with the ▲ and ▼ keys 1
- Validate the modifications OK

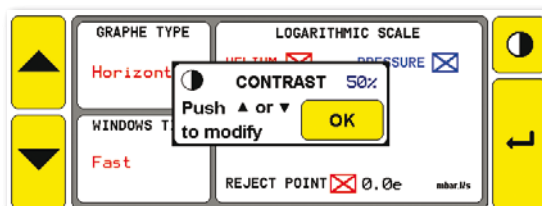

Control panel with graphic interface

Memorized graph

Recording

Dynamic graph on the screen

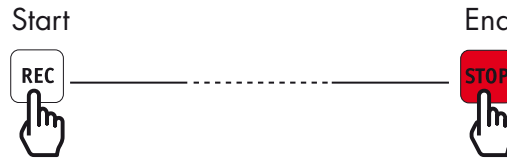

The recording time is displayed at the bottom left of the screen.

The red key **STOP** is displayed as soon as a recording is in process.

Notes:

- If the memory is not erased between 2 recordings (**CLEAR**) all the successive recordings are on the same memorized graph. A cursor indicates the end of each recording. A cursor indicates the end of each recording.

example:

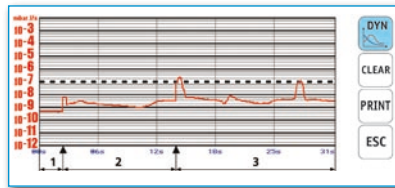

3 recordings on a same memorized graph

- When the memory is full and a recording is in process, the recording is automatically stopped and the following message displayed:

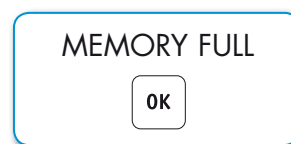

- It is possible during a recording to show or to enlarge the curve portions already memorized, without stopping it. To do this, press **MEM**



Similarly, it is possible to use all the control panel functions : menu access, start a cycle, auto-calibration, ...

Note: In the case of an auto-calibration with an external leak, set the standard interface in order to follow in the screen the instructions given by the leak detector.

- Recording continues until we press **STOP** .



Every leak detector stop or control panel disconnection will erase the memory. Save the memorized graph (if required) before these operations.

Control panel with graphic interface

Display Reach the memorized graph by tapping on the  key.

Note:

- You can go to the memorized graph as soon as you have recorded at least 2 points.
If no recording has been done, the following message displays:

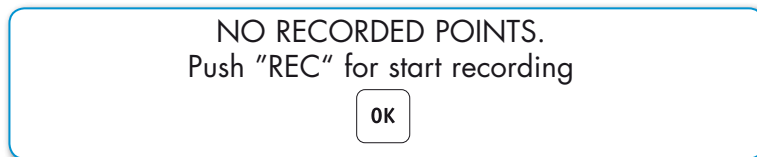

Zoom The memorized graph allows you to enlarge curve areas. You only should define the targeted area with 2 point:

- Zoom in: with your finger or a pen, tap on the screen to set point **1**, and **2**, and tap on the **ZOOM** **3** key.

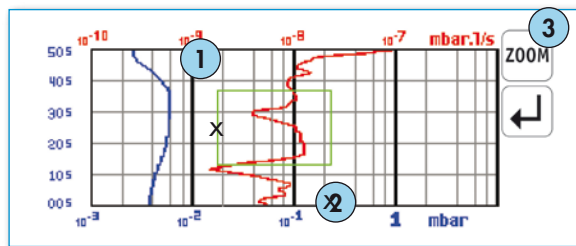

- Zoom in: with your finger or a pen, tap on the screen to set point **1**, and **2**, and tap on the **ZOOM** **3** key.

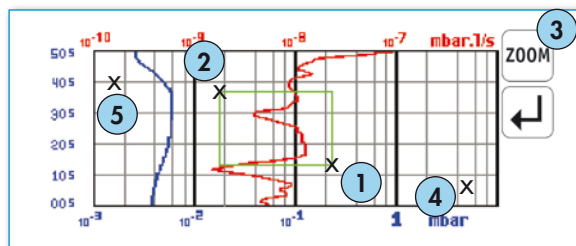

- To return to the previous zoom out, set points **1** and **2** nearby (maximum 40 zooms out could be memorized).
- To return to the original graph (complete zoom out), put the points **4** and **5** very distant.

Notes:

- After having defined the targeted area, and before pressing **ZOOM**, it is possible to modify the targeted area: move the area sides or angles with the finger.

Control panel with graphic interface

- You can enlarge as many times as you want until the displayed period is equal to the sampling time set (until 2 points visible on the graph).
- You can only enlarge the complete decades: you can not enlarge inside a decade.

Point measure The memorized graph allows you to give the exact measure of every memorized graph point at a "t" time.

- Press on **MEAS** key **1**.

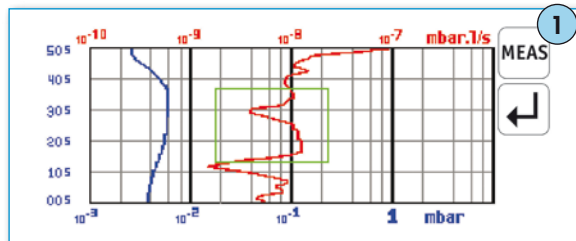

- A target **2** appears at the screen center.

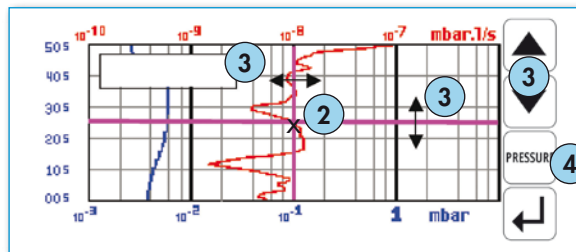

The target is the curve point to measure. It is possible to change the target: move the axes with the finger or arrows **3**.

- To switch the target from the helium signal curve to the inlet pressure curve, press the key **4**.

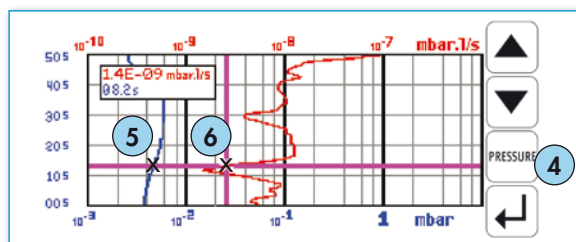

1.4E-09 mbar.l/s → helium signal value **6** or inlet pressure **5**
08.2 s → measure time (t)/recording start

Control panel with graphic interface

Memorized graphs saving

It is possible to do a screen copy (.bmp) or to create a file (.txt) with the measures memorized. The .txt file is compatible with Excel: the separator by default is "tab".

Notes:

- The .txt and .bmp files saved correspond to the curve points displayed on the screen:
 - To have all the points, it is essential to be on the original graph (no zoom).
 - If a zoom has been done before the saving, the saving corresponds only to the curve points displayed in the selected area.
- If the memorized graph is made up of several successive recordings:
 - the "▶" cursor will indicate each change of recording on the .bmp file.
 - "break down n°" message will be indicated at the end of the last line of each recording.
- If you press  key while the remote control is connected to the leak detector, the leak detector will be out of order.

To remedy it, press  and disconnect/reconnect the remote control.

Material

- A specific cable to connect the control panel with the PC.
Part number: **A461946**
 - Delivered with all the leak detectors equipped of the "control panel with graphic interface" option.
 - Not included in the "control panel with graphic interface" accessory.
 - A specific software "ASM Downloader" should be set in your PC download it:
 - either on our internet **Address: www.adixen.com/Ressources/Tools**
 - or from the sheet  **G 800**.
 - PC configuration:
 - PC 300 MHz, 128 Mb RAM, 50 Mb hard drive, Graphic card 800 x 600 x 256 colors.
 - Windows 98, Windows 2000, Windows XP
- Display the memorized graph to the screen.

Control panel with graphic interface

Procedure On the control panel, start the saving



Connect the cable



Don't try to execute the software as long as this screen is not displayed.

On the PC, execute the specific software

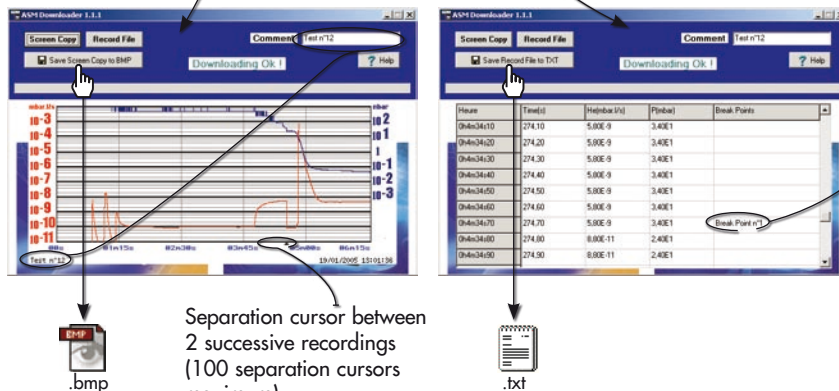

Separation message between 2 successive recordings

Separation cursor between 2 successive recordings (100 separation cursors maximum)

On the control panel, close the specific software



Control panel with graphic interface

Animated synoptic Synoptic reading

Please refer to the "Change of interface" paragraph to reach it.

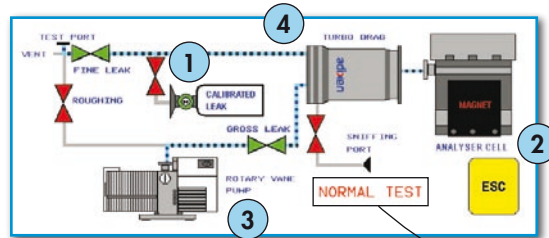

Etat du detecteur

① ② ③ ④ interactive components

- Valve closed
- Valve opened
- Inactive canalization
- Active canalization: gas flow

When you press on the interactive components, you have a section of the component or its operating principle. To return to the original illustration, press again on the component.

Example

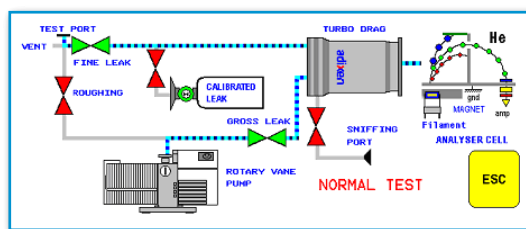
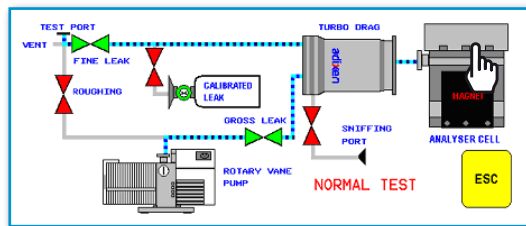

Note:

- The synoptic is personalized for each leak detector.

Long distance sniffer probe and Helium spray gun

Please refer to the specific sheets for the instruction:



Long distance sniffer probe
 G 400 / G 410



Helium spray gun  G 500

Inlet vent

A help for control panel utilization/access.

Operating principle of the control panel



Access to level 4 - Password



Setting and maintenance part presentation of the control panel



Summary of screens



Access to parameters and parameters active depending on authorization

Complete displays list with access way and associated sheet

Choices proposed to the operator

The operator can connect the leak detector:

- to the vent air function,
- the gas line option (ASM 182 TD+ only).

At any time, during or after test, the inlet status is displayed on the LCD and it is possible to control it (except for user level interface 1).

The proposed default value is "off" (= valve closed).

Inlet: Air Vent

Air vent purpose

At the end of a test cycle, 2 possibilities are available:

- venting (putting back to atmospheric pressure)
- not venting (keeping under vacuum) the part or installation tested.

This one can be made in a automatic or forced way.

That is why, the operator should program the following parameters:

- air vent at the end of a test cycle ("air off"/"air on")
- activation of this air vent ("automatic"/"operator").

Air inlet activation at the end of the cycle	Air inlet at the end of the cycle	After the test
Automatic	On	Automatic air inlet
	Off	No automatic air inlet
Operator	On	No automatic air inlet
	Off	Forced way air inlet by the operator

Inlet vent

Air vent Opening / Closing

Stand-by screen

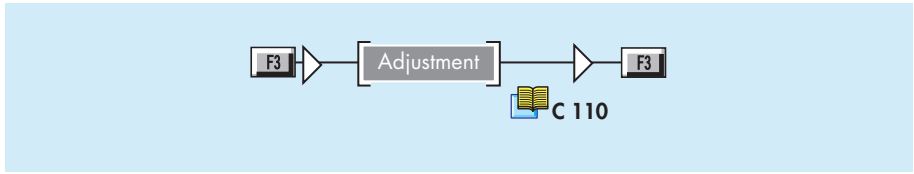

The inlet vent status indicated in the stand-by screen gives always the inlet vent valve status on the stand-by

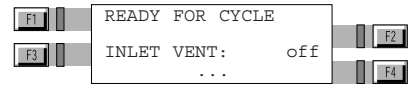

- On => valve opened
- Off => valve closed

Air vent adjustment

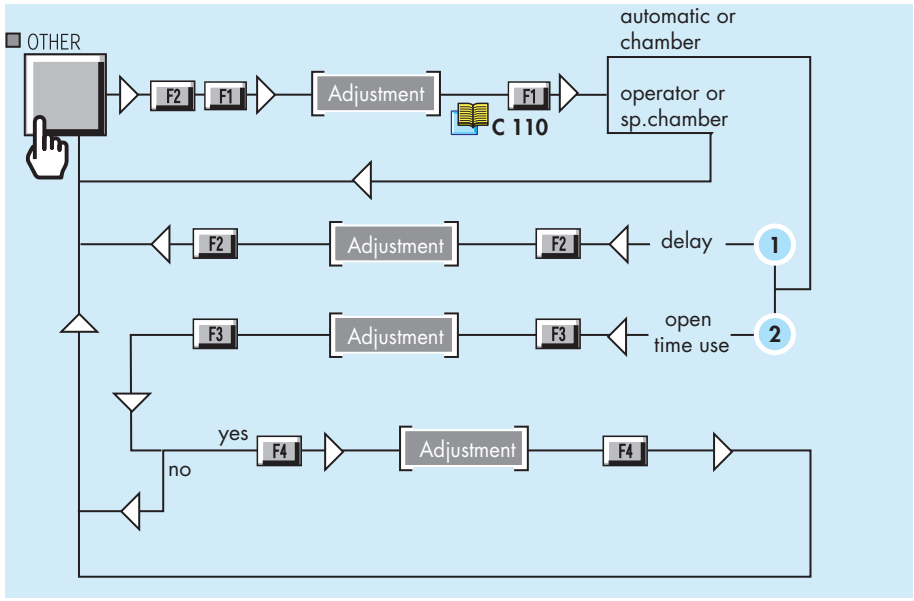

Note:

- 1** Delay - Time between the end of the cycle and the inlet vent valve opening. Only 3 possibilities: 0 - 1 s - 2 s
- 2** Open time use - The user can close again the inlet vent valve after opening (yes/no). When used (yes), set timer = time between inlet vent valve opening and inlet vent valve closing again.

Inlet: gas line option

(ASM 182 TD+ only)



Bargraph zoom

A help for control panel utilization/access.

Operating principle of the control panel



C 110

Setting and maintenance part presentation of the control panel



C 120

Access to parameters and parameters active depending on authorization

Access to level 4 - Password



C 130

Summary of screens



C 140

Complete displays list with access way and associated sheet

Purpose This function offers a better resolution of the readout as well as a better view of the helium signal behaviour around the set point.

This function requires a remote control or a control panel with an analog display use.

Activate/deactivate the bargraph zoom

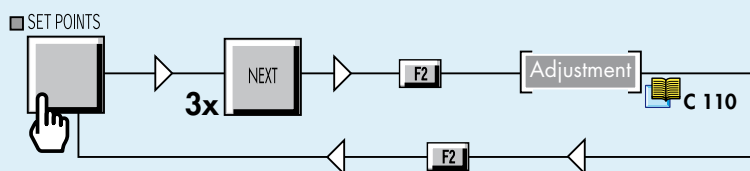

Bargraph zoom

Analog display When a bargraph zoom is activated, use the helium signal zero scale: a blinking led indicates the reject point.

Remote control & control panel

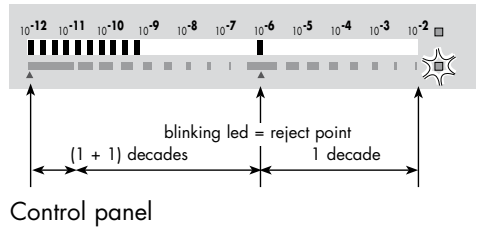
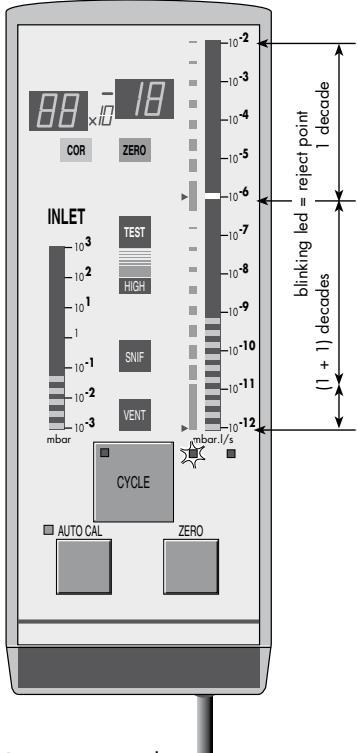

The helium signal zero scale displays the leak value in 2 colors following the measured leak value:

- if the measured leak value is under the reject point, the flashing leds are green,
- if the measured leak value exceeds the reject point, the flashing leds are red (and the blinking led orange).

Reject point C 211

Remote control

Zero function & Bargraph zoom

When bargraph zoom and zero functions are ON in the same time, the operator must read measured leak value in this way as follow:

- digital display
The leak value displayed is the value corrected with zero function.

Zero function C 540

- analog display
Use the helium signal zero scale.
The analog display is the actual bargraph zoom display (see above).

Audio alarm / Digital voice

A help for control panel utilization/access.			
Operating principle of the control panel	C 110	Access to level 4 - Password	C 130
Setting and maintenance part presentation of the control panel Access to parameters and parameters active depending on authorization	C 120	Summary of screens Complete displays list with access way and associated sheet	C 140

Audio alarm definition

The Audio alarm appears differently, based on the Zero function.

- Zero function is not activated:
The Audio alarm is started when the helium signal is exceeding a set point and called reject point.
- Zero function is activated:
The audio alarm threshold is then called "floating". It is slightly set above the zero level and will be triggered for any rise of the helium signal.

Zero function C 540

Digital voice definition

The digital voice informs the operator by sending audio messages in the following cases:

- starting-up process and auto-calibration process
- when detector is ready
- rejected part
- fault.

General

At any time it is possible to adjust the volume:
 ■ to increase volume ■ to decrease volume



Sound level

The level varies from 0 to 8 (= 90 dBA).

Adjustment

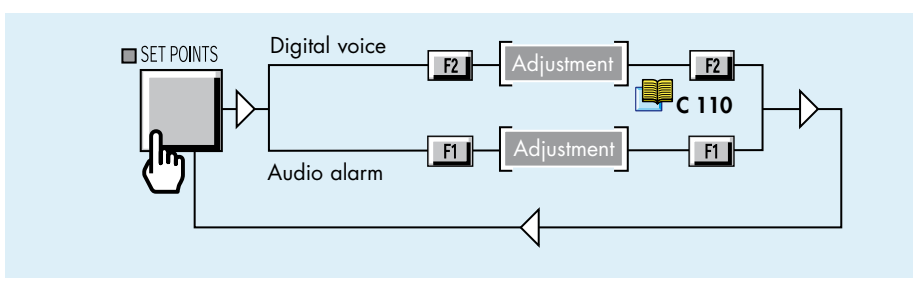

Cycle end

A help for control panel utilization/access.

Operating principle of the control panel

 C 110

Access to level 4 - Password

 C 130

Setting and maintenance part presentation of the control panel

 C 120

Summary of screens

 C 140

Access to parameters and parameters active depending on authorization

Complete displays list with access way and associated sheet

Purpose of the cycle end

It allows an automatic control of the roughing time and measure time i. e. the end of cycle.

- Cycle end: operator - Operator stops the cycle ()
- Cycle end: automatic - Cycle is stopped automatically.

Note: if Cycle end is automatic, the parameters of roughing and measure times are automatic.

Activate / Deactivate the Cycle end

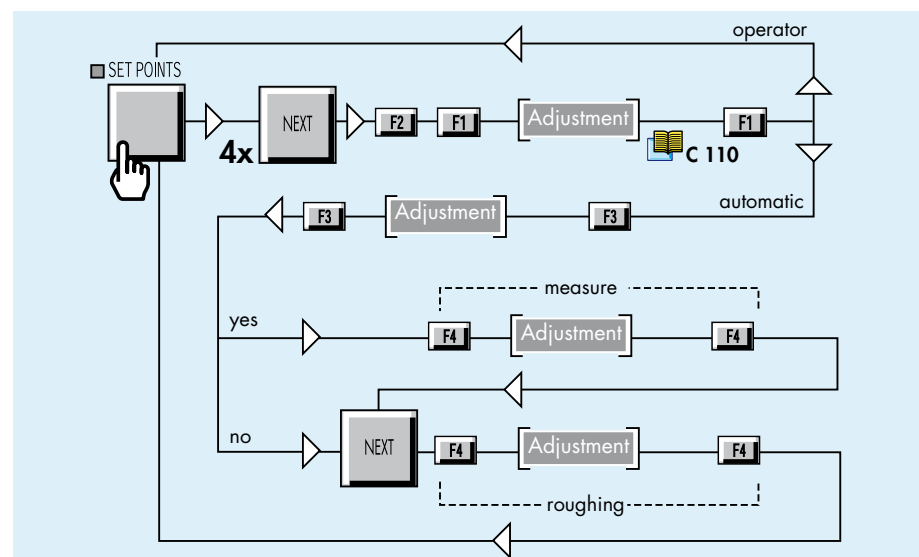

• Roughing

Roughing timer determines maximum authorized roughing time before the tested part is considered as bad.

To consider the tested part as bad, it is necessary to activate the Memo function.

Memo function  C 550

• Measure

If Cycle end is activated (automatic), user should adjust the measure timer i.e. the cycle end.

The measure timer corresponds to the time allowed for the leak detector to remain in test. When it is reached, the measure flashes.

Cycle end

A help for control panel utilization/access.

Operating principle of the control panel

 C 110

Access to level 4 - Password

 C 130

Setting and maintenance part presentation of the control panel

 C 120

Summary of screens

 C 140

Access to parameters and parameters active depending on authorization

Complete displays list with access way and associated sheet

Purpose of the cycle end

It allows an automatic control of the roughing time and measure time i. e. the end of cycle.

- Cycle end: operator - Operator stops the cycle ()
- Cycle end: automatic - Cycle is stopped automatically.

Note: if Cycle end is automatic, the parameters of roughing and measure times are automatic.

Activate / Deactivate the Cycle end

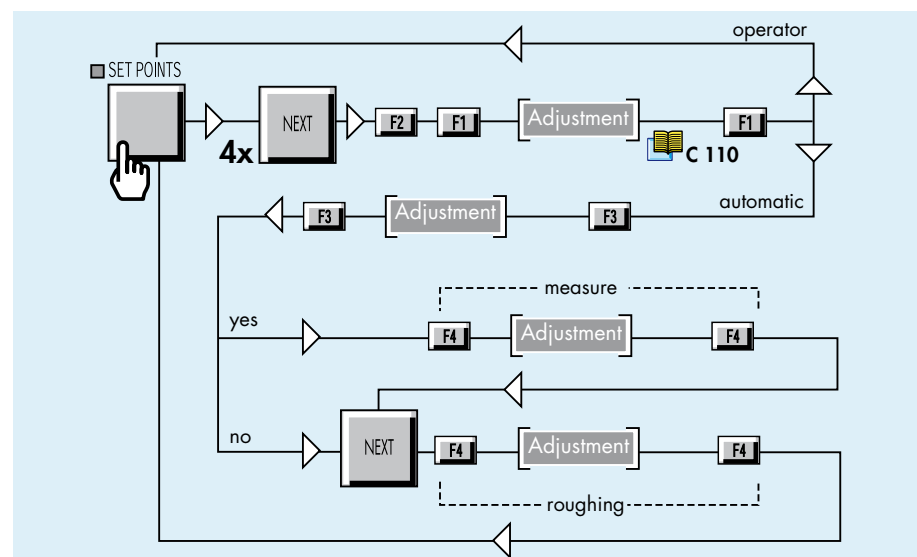

• Roughing

Roughing timer determines maximum authorized roughing time before the tested part is considered as bad.

To consider the tested part as bad, it is necessary to activate the Memo function.

Memo function  C 550

• Measure

If Cycle end is activated (automatic), user should adjust the measure timer i.e. the cycle end.

The measure timer corresponds to the time allowed for the leak detector to remain in test. When it is reached, the measure flashes.

Zero function

A help for control panel utilization/access.			
Operating principle of the control panel	C 110	Access to level 4 - Password	C 130
Setting and maintenance part presentation of the control panel Access to parameters and parameters active depending on authorization	C 120	Summary of screens Complete displays list with access way and associated sheet	C 140

Purpose Zero function is provided:

- to help the operator to identify a very small fluctuation of the helium signal out of the ambient background,
- to enlarge small fluctuations of the helium signal on the analog display.

The zero function could be activated:

- by the operator,
- in automatic.

It's advised to use this function when helium background signal is low.

Activate the zero function The process of the zero function is the same whatever the activation mode (operator or automatic). The only difference is when the background suppression activation is automatic, the operator does not need to press .

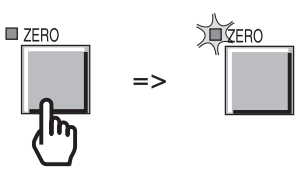

Principle example

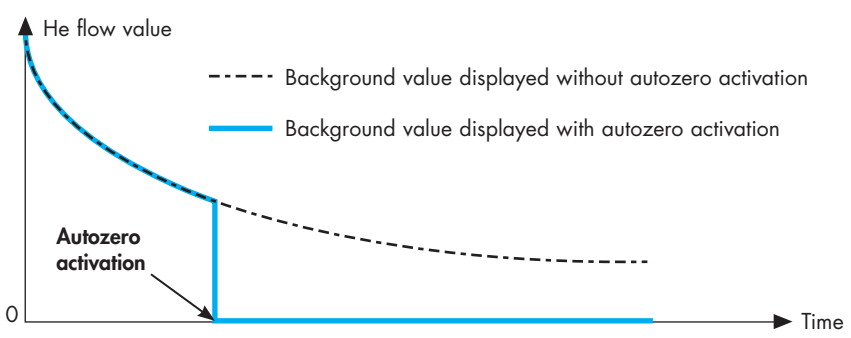

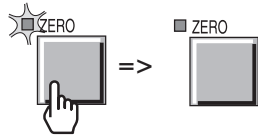

Zero function

Deactivate the zero function

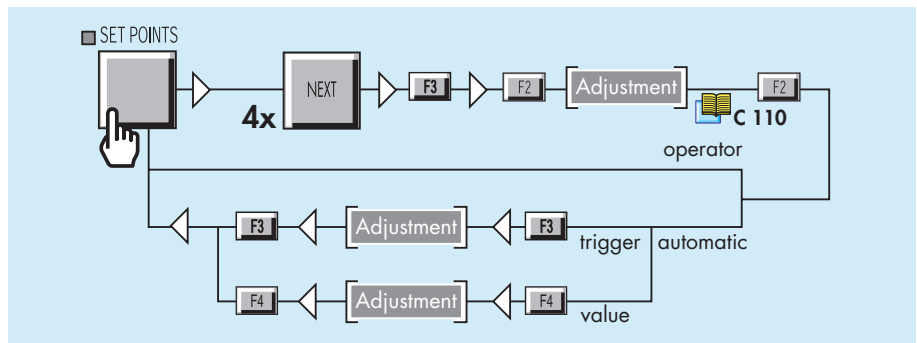

Activation/Deactivation of the background



The trigger parameter corresponds to the value at which the zero function is selected. It could be a timer or set point.
 (= press  if activation = operator)

The autozero will start:

- every time that the parameted set point is reached (if trigger set).
- regulary, depending on the defined frequency (if timer set).

Display

- Display changes according to the activation or not of the "bargraph zoom on reject point" ( C 510) function.
- Example with a calibrated leak of 1×10^{-8} mbar.l/s

Zero not activated

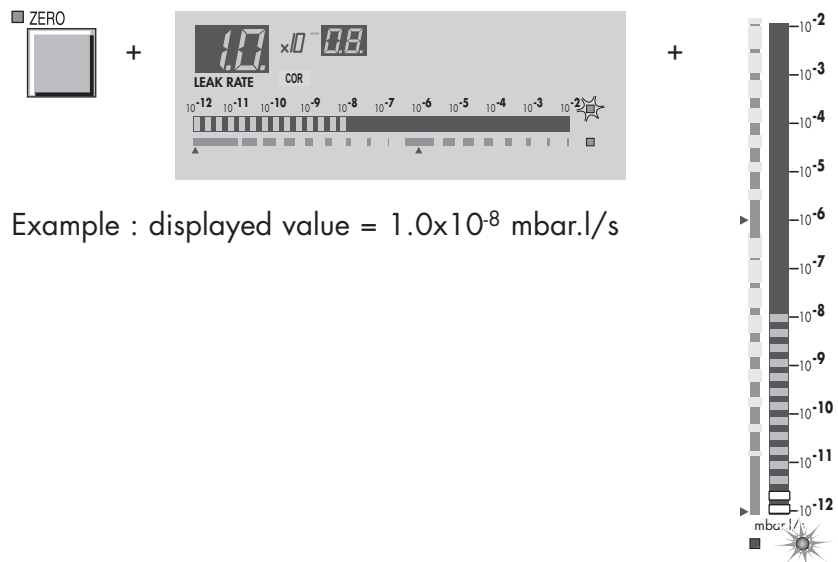

Example : displayed value = 1.0×10^{-8} mbar.l/s

Zero function

Zero activated

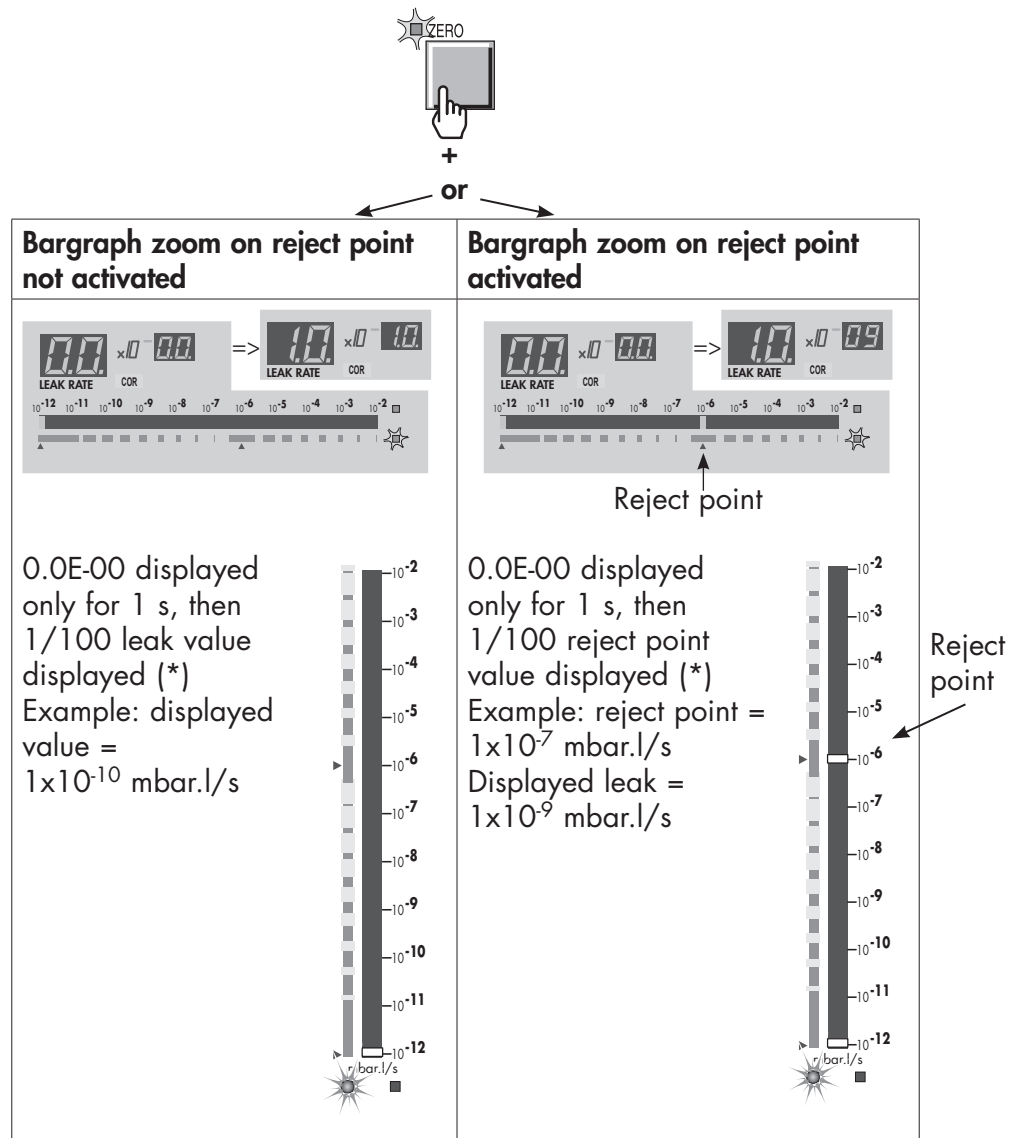





(*) Note: The 1/100 reject point value or 1/100 leak value displayed is limited to the low limit of the measurement range in the selected test mode.

Example: ASM 142 in Normal test mode

Test mode	mbar.l/s
Gross leak	1×10^{-9} to 1
Normal	1×10^{-11} to $3 \cdot 10^{-4}$
Sniffing	1×10^{-7} to $1 \cdot 10^{-1}$

The 1/100 reject point value or 1/100 leak value will never be lower than 1×10^{-11} mbar.l/s. Refer to **A 800** for the limit values according to the leak detector.

Memo function

A help for control panel utilization/access.	
Operating principle of the control panel Setting and maintenance part presentation of the control panel Access to parameters and parameters active depending on authorization	 C 110  C 120
Access to level 4 - Password Summary of screens Complete displays list with access way and associated sheet	 C 130  C 140

Purpose This function freezes the display showing the result of the previous test. The measured value flashes and blinks until a new test cycle is started (display timer deactivated).

Activate/Deactivate the memo function

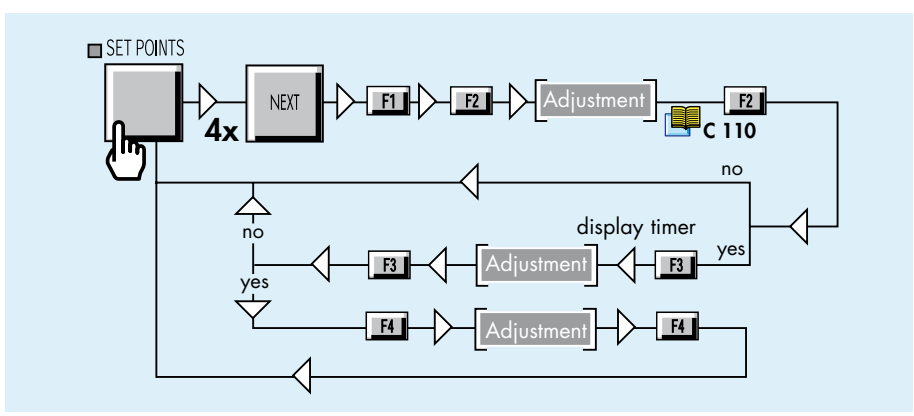

Display timer Once the memo function is activated, user has the possibility to activate or not the display timer. Display timer determines the time during which measured leak value is displayed.

Helium pollution prevention

A help for control panel utilization/access.

<p>Operating principle of the control panel</p> <p>Setting and maintenance part presentation of the control panel Access to parameters and parameters active depending on authorization</p>	<p> C 110</p> <p> C 120</p>	<p>Access to level 4 - Password</p> <p>Summary of screens Complete displays list with access way and associated sheet</p>	<p> C 130</p> <p> C 140</p>
---	-----------------------------	---	-----------------------------

Purpose The helium pollution prevention function prevents the detector from being polluted by helium when the part or installation to be tested contains a lot of helium. Leak detector in test mode, if the signal increases quickly above depollution reject point, the cycle is automatically ended and the leak detector stays in stand-by mode until the helium has decreased.

Note: There is no message to inform the operator that the detector is over again ready for a new test.

Note:

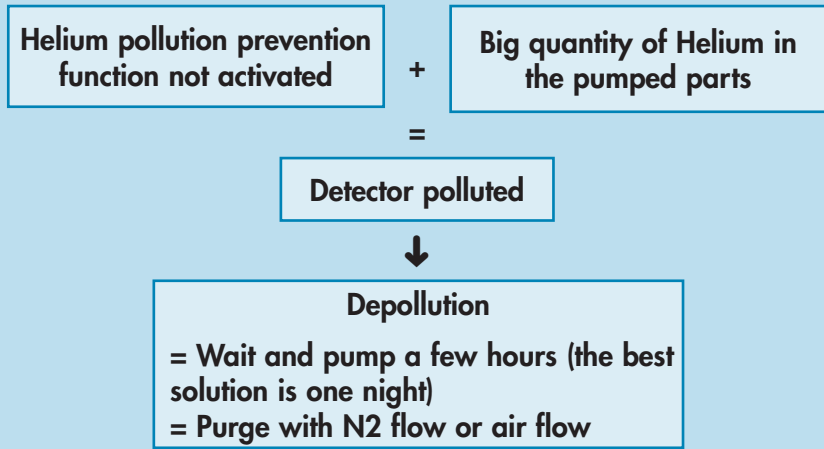

Note: When the detector reaches the 10^{-4} mbar threshold, it automatically pass in gross leak test mode.

Activate/Deactivate the Helium pollution prevention

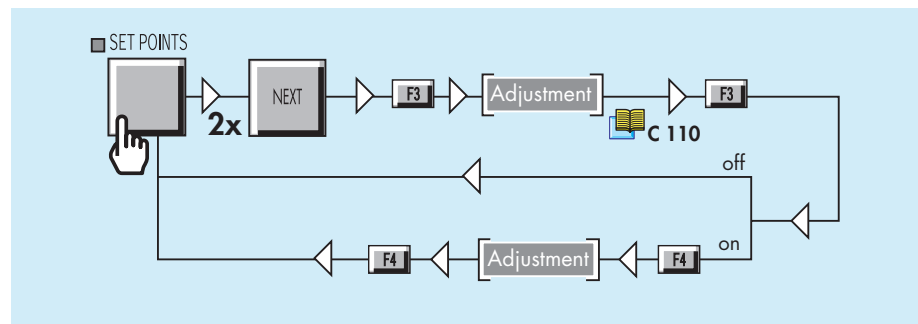

Date - Time - Language - Unit

A help for control panel utilization/access.

Operating principle of the control panel



Access to level 4 - Password



Setting and maintenance part presentation of the control panel



Summary of screens



Access to parameters and parameters active depending on authorization

Complete displays list with access way and associated sheet

Adjustment procedure

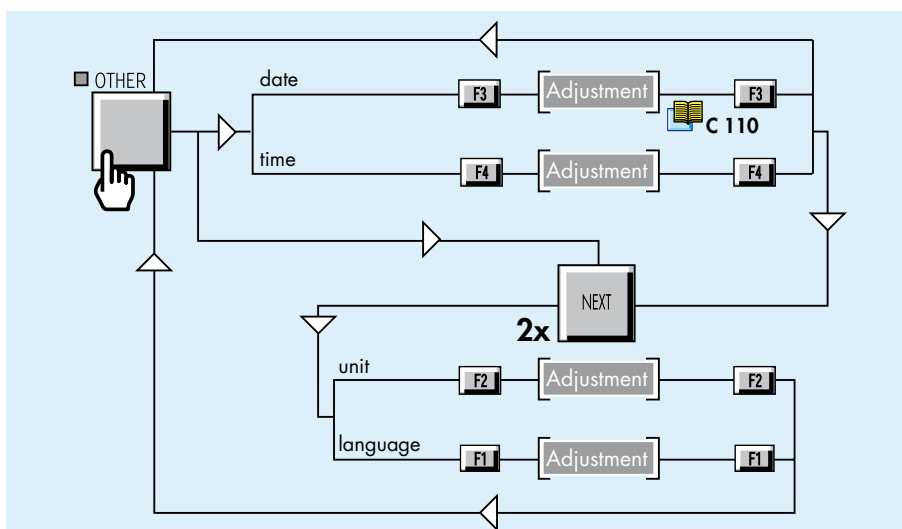

Date The leak detector calculates its storage period since the last switching off. C 200

Take care to set the correct date.

Language The leak detector offers 2,3 or 4 languages, according to the model.

Notes:



- All messages on the LCD are on the selected language.
- The selected language is the language of the digital voice.

Digital voice C 520

Unit The leak detector offers 3 units:

- mbar.l/s
- Pa.m³/s
- Torr.l/s

When the operator connects the remote control on the leak detector, the leak detector unit is automatically reprogrammed with the unit of the remote control.

The remote control unit is memorized by the detector when the operator disconnects the remote control.

Fault / information indicator and display

Fault and information

At any time, the leak detector can display on the LCD clear Information or Fault messages based on the analysis of the leak detector status.

There are 3 basic types of faults: **minor fault**, **major fault** and **critical failure**.

There are 2 basic types of information: **user information** and **service information**.

The messages are displayed on a specific display by order of importance:

1. critical failure
2. major fault and minor fault
3. user information and service information

Faults Minor fault

3 fault types: minor fault, major fault and critical failure.

- Warning:
 - on the digital display alternatively the helium signal and "Er" are shown.
 - on the LCD, a "!" flashing at the right end of the 1st line.

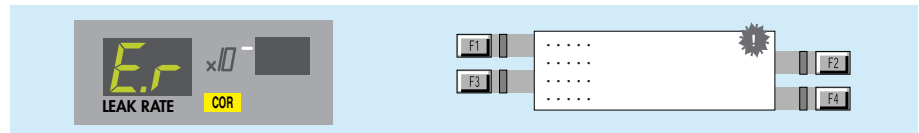

The digital voice advises the operator of the procedure to follow.

- Result:
 - This will not stop the functions of the leak detector but can affect the validity of the test result.

- Message:
 - To read the message



A clear message describes the error on line 2 and 3. The most important warning message is displayed on the 1st line.

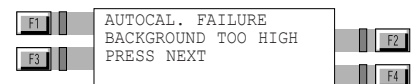

Up to 3 messages may be displayed on the message display.

- Duration: may be temporary or permanent
 - temporary if the fault appears and then disappears without a corrective action from the user
 - permanent until the cause is erased by the user.
- Remedy:
 - Temporary: the indicator disappears and the warning message is erased.
 - Permanent: both indicator and message are memorized until the fault is eliminated.

Fault / information indicator and display

Faults (cont.)

ASM 142 S and ASM 102 S special case:

- If after the start, the background is lower than the sniffer probe clogged point:
 - The "AL" message appears permanently on the digital display,
 - a «!» flashing at the right end of the screen.
- This default, although minor, is blocking. It is necessary to launch a calibration to make it disappear.



Major fault

- Warning:
 - on the digital display, "Er" is permanently displayed.
 - a flashing message occurs on the LCD

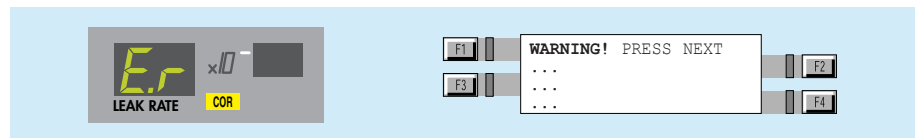

The digital voice advises the operator of the procedure to follow.

- Result:
 - May prevent the leak detector from making a vacuum test or an autocalibration

- Message:

To read the message 

Note: A major fault can behave like a temporary minor fault if the origin of the error has disappeared.

Critical failure

- Warning:
 - on the digital display, "Er" is permanently displayed. All indicators are turned off.
 - on the LCD the clear message of a critical failure is directly displayed. Details are displayed on line 2 and 3.

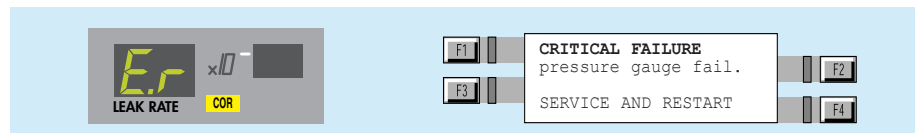

The digital voice advises the operator of the procedure to follow.

- Result:
 - Complete shut down of the leak detector is required.
- Remedy:
 - Need the servicing of the leak detector before starting it again.

Fault / information indicator and display

Information 2 information types: **user** and **service information**.

- Warning:
 - no indicator on the digital display
 - on the LCD, a "i" flashing at the right end of the 1st line.

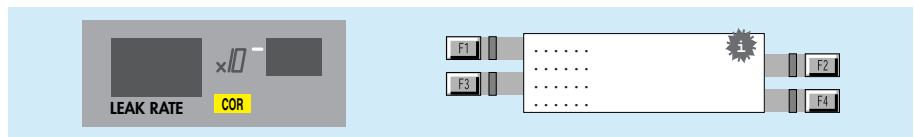

- The digital voice advises the operator of the procedure to follow.

- Result:
 - Doesn't affect the functions of the leak detector

- User information

Only an indication that the leak detector is in a particular status which may require an action from the user in order to return to a standard situation

- Service information

Only an indication that the leak detector requires a service or maintenance action.

- Message:

To read the message 

A clear message describes the fault on line 2 and 3.

User information display

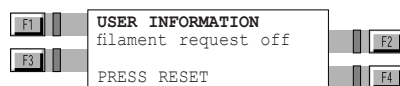

Service information display

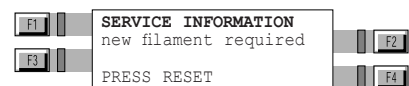

- Duration:

After display of the clear message, the indicator and the clear message are erased but they will be reactivated at the next start-up of the leak detector or at each unauthorized request by the user or 30 min later, if the origin of the message is still present.

- Remedy:

- User information

Can be eliminated by an action which is accessible by the user.

- Service information

Can be eliminated by a service action on the involved component and by resetting the corresponding configuration parameter. This is only accessible by the customer service.

Service instructions  E

Fault / information indicator and display

List of messages

For all messages, note their contents in order to identify the origin of the message and take the corresponding corrective action if necessary.

General troubleshooting guide  D 300

The RS 232 codes of these messages are described in the specific RS 232 user manual.

	User Information	Service Information	ASM 182 T	ASM 192 T	ASM 192 T2	ASM 182 TD+	ASM 192 TD+	ASM 192 T2D+	ASM 122 D	ASM 142	ASM 142 D	ASM 142 S	ASM 1002	ASM 102 S	ASI 22
Information messages															
auto. cal. required		•													•
filament request off	•		•	•	•	•	•	•	•	•	•	•	•	•	•
manual calibration	•		•	•	•	•	•	•	•	•	•	•	•	•	•
auto. cal. aborted	•		•	•	•	•	•	•	•	•	•	•	•	•	•
drift too high (zero)	•		•	•	•	•	•	•	•	•	•				
He too high for zero	•		•	•	•	•	•	•	•	•	•	•	•		•
He too low for zero	•		•	•	•	•	•	•	•	•	•	•	•		•
external calib. Leak	•		•	•	•	•	•	•	•	•	•	•	•		•
new fil#1 required		•	•	•	•	•	•	•	•	•	•	•	•	•	•
new fil#2 required		•	•	•	•	•	•	•	•	•	•	•	•	•	•
maintenance required		•	•	•	•	•	•	•	•	•	•	•	•	•	•
fil1-collector short		•	•	•	•	•	•	•	•	•	•	•	•	•	•
fil2-collector short		•	•	•	•	•	•	•	•	•	•	•	•	•	•
press zero & spray He	•		•	•	•	•	•	•	•	•	•	•	•		
no Hy leak for calib	•		•	•	•	•	•	•	•	•	•	•	•		
rough. MDP pump maint.		•						•(5)							
rough. ATP pump maint.		•						•(2)				•		•	
auto. cal. required	•		•	•	•	•	•	•	•	•	•	•	•	•	•
external leak maint.		•										•		•	
internal leak maint.		•										•			
primary pump maint.		•				•(4)	•(4)	•(4)	•(8)		•(10)			•(12)	•(3)
high. vac pump maint		•	•(1)	•(1)	•(1)	•(1)	•(1)	•(1)	•(7)	•(9)	•(9)	•(9)	•(11)	•(5)	
roughing pump maint.		•		•(2)	•(3)	•(3)	•(3)		•(6)		•(5)				

(1) TMP 5154
 (2) ATP 100
 (3) MDP 5011
 (4) ACP 28

(5) MDP 5006 HDS
 (6) ATH 31+
 (7) ATH 31
 (8) Dry pump

(9) AMP 007 I
 (10) AMD 1
 (11) ATH 164
 (12) Diaphragm pump

Fault / information indicator and display

Error message	Minor failure	Major failure	Critical failure	ASM 182 T	ASM 192 T	ASM 192 T2	ASM 182 TD+	ASM 192 TD+	ASM 192 T2D+	ASM 122 D	ASM 142	ASM 142 D	ASM 142 S	ASM 1002	ASM 102 S	ASI 22
autocal failure	•			•	•	•	•	•	•	•	•	•	•	•	•	•
temperature too low	•			•	•	•	•	•	•	•	•	•	•	•	•	•
temperature too high	•			•	•	•	•	•	•	•	•	•	•	•	•	•
cal. leak year error	•			•	•	•	•	•	•	•	•	•	•	•	•	•
peak search error	•			•	•	•	•	•	•	•	•	•	•	•	•	•
peak adjust error	•			•	•	•	•	•	•	•	•	•	•	•	•	•
background too high	•			•	•	•	•	•	•	•	•	•	•	•	•	•
emission loss	•			•	•	•	•	•	•	•	•	•	•	•	•	•
cell. zero off limits	•			•	•	•	•	•	•	•	•	•	•	•	•	•
cell. zero stability	•			•	•	•	•	•	•	•	•	•	•	•	•	•
calib. test mode lost	•			•	•	•	•	•	•	•	•	•	•	•	•	•
sensitivity too high	•			•	•	•	•	•	•	•	•	•	•	•	•	•
background trouble	•			•	•	•	•	•	•	•	•	•	•	•	•	•
lack of sensitivity	•			•	•	•	•	•	•	•	•	•	•	•	•	•
cell.pressure safety		•		•	•	•	•	•	•	•	•	•	•	•	•	•
triode safety		•		•	•	•	•	•	•	•	•	•	•	•	•	•
emission failure		•		•	•	•	•	•	•	•	•	•	•	•	•	•
snif. probe clogged		•		•	•	•	•	•	•	•	•	•	•	•	•	•
high. vac pump speed		•		•	•	•	•	•	•	•	•	•	•	•	•	•
cell pres.>0.01 mbar			•	•	•	•	•	•	•	•	•	•	•	•	•	•
high. vac pump fail			•	•	•	•	•	•	•	•	•	•	•	•	•	•
cell pres.>1e-04 mbar			•	•	•	•	•	•	•	•	•	•	•	•	•	•
filaments #1 bad			•	•	•	•	•	•	•	•	•	•	•	•	•	•
no collector voltage			•	•	•	•	•	•	•	•	•	•	•	•	•	•
time keeper ram fail.			•	•	•	•	•	•	•	•	•	•	•	•	•	•
cell. gauge failure			•	•	•	•	•	•	•	•	•	•	•	•	•	•
rough. pump failure	•					•(2)	•(3)	•(3)	•(2)	•(6)		•(5)				
24 V DC troubles	•			•	•	•	•	•	•	•	•	•	•	•	•	•
mini reject point on	•													•		
check ATH connector			•							•(7)						
check AMP connector			•								•(9)	•(9)	•(9)		•(5)	•(3)
check TMP connector			•	•(1)	•(1)	•(1)	•(1)	•(1)	•(1)					•(11)		
check ATH connector			•							•(6)						
check MDP connector			•				•(3)	•(3)	•(5)			•(5)				
check ATP connector			•			•(2)			•(2)							
LDS probe problem		•											•		•	

Fault / information indicator and display

	Minor failure	Major failure	Critical failure	ASM 182 T	ASM 192 T	ASM 192 T2	ASM 182 TD+	ASM 192 TD+	ASM 192 T2D+	ASM 122 D	ASM 142	ASM 142 D	ASM 142 S	ASM 1002	ASM 102 S	ASI 22
Error message																
dynamic cal failure	•															•
bad RAM integrity	•															•
fil1-collector short		•		•	•	•	•	•	•	•	•	•	•	•	•	•
fil2-collector short		•		•	•	•	•	•	•	•	•	•	•	•	•	•
fil1-collector short			•	•	•	•	•	•	•	•	•	•	•	•	•	•
fil2-collector short			•	•	•	•	•	•	•	•	•	•	•	•	•	•
high. vac pump speed			•	•	•	•	•	•	•	•	•	•	•	•	•	•
rough. pump failure			•			•(2)	•(3)	•(3)	•(2)	•(6)		•(5)				
primary pump failure			•	•(12)	•(12)	•(4)	•(4)	•(4)						•(12)		

- (1) TMP 5154
- (2) ATP 100
- (3) MDP 5011
- (4) ACP 28

- (5) MDP 5006 HDS
- (6) ATH 31+
- (7) ATH 31
- (8) Dry pump

- (9) AMP 007 I
- (10) AMD 1
- (11) ATH 164
- (12) Diaphragm pump



Maintenance - Troubleshooting

ASM 142 - ASM 142 D
ASM GRAPH - ASM GRAPH D
ASM GRAPH D+

User's Manual

Detailed contents

Preliminary remarks Throughout this User's Manual, you could find this type of message "Summary of screen  C 140": it refers to a specific chapter of the User's Manual. Please read it for further information.

D 100

Table of preventive maintenance intervals

D 200

Maintenance message

- Definition
- Adjustment of the counters

D 300

General troubleshooting guide

D 300 / D 400

General troubleshooting guide/Symptoms description

D 400

Symptoms description

Table of preventive maintenance intervals

Frequency* Maintenance operations to be performed		ASM 102 S	ASM 122 D	ASM 142	ASM 142 S	ASM 142 D	ASM Graph D+	ASM 182 T	ASM 192 T	ASM 192 T2	ASM 182 TD+	ASM 192 TD+	ASM 192 T2D+	ASM 1002	ASI 22
1000 h ⁽¹⁾	Clean filters (inlet filters, air inlet filter)	-	•	•	•	•	•								•
2000 h ⁽¹⁾ or 3 months ⁽²⁾	Change the rotary vane pump oil. Change the oil mist eliminator.	E 750		•	•			•	•	•				•	
4000 h ⁽¹⁾ or 6 months ⁽²⁾	Clean the vacuum lines, the valves and the gauges with alcohol - Dust the electronic boards and the fans. Partial maintenance of the analyzer cell: Replace analyzer cell filaments and collector. Clean the analyzer cell with alcohol (this cleaning may be necessary in case of general internal contamination creating insulating deposits).	E 400	•	•	•	•	•	•	•	•	•	•	•	•	•
8000 h ⁽¹⁾ or 1 year ⁽²⁾	Sniffer probe filter replacement if used.	G 200	•	•	•	•	•	•	•	•	•	•	•	•	
	Pirani gauge adjustment.	M E 500						•	•	•	•		•		
	AP 1004/APT 1004 gauge adjustment.	M E 520 M E 522		•										•	
	Electronic overhaul	-		•											•
	Replace the seal in the rotary vane pump.	M RVP TRM						•	•					•	
	AMD1 pump: replacement of membranes and check valves. Change the inlet filter of the test chamber.	E 710					•								
10000 h ⁽¹⁾	Replacement of membranes and replacement of valves.	M E 770	•												
	Primary pump maintenance/ replacement of membranes and valves.	M E 780		•											

*Service intervals: The service intervals given are for applications and work rates which conform to the normal operating conditions. If the machine is operating under more difficult conditions they can be shortened.

(1) running time

(2) running time or storage

(3) storage

Table of preventive maintenance intervals

Frequency*	Maintenance operations to be performed		ASM 102 S	ASM 122 D	ASM 142	ASM 142 S	ASM 142 D	ASM Graph D+	ASM 182 T	ASM 192 T	ASM 192 T2	ASM 182 TD+	ASM 192 TD+	ASM 192 T2D+	ASM 1002	ASI 22
12000 h ⁽¹⁾	Regrease the molecular pump.	E 740	•				•		•	•	•	•		•		
	Regrease the turbomolecular pump.	E 740					•	•	•	•	•	•		•		
	Regrease the ATP 100 or ATH 164 pump.	E 740									•			•	•	
	Regrease the AMP0071 molecular pump.	E 740			•	•	•	•								
15000 h ⁽¹⁾	Replace the ball bearings of the ATH 31 pump.	M ATH 31 TRM		•												
16000 h ⁽¹⁾ or 2 years ⁽³⁾	Recalibration/exchange of the internal calibrated leak or calibrated leak used for calibration.	E 570	•	•		•	•	•	•	•	•	•		•	•	
	Complete service of the rotary vane pump.	M RVP TRM			•	•			•	•	•				•	
22000 h ⁽¹⁾ or 1 year ⁽³⁾	Replace the ball bearings and the seals of the molecular pump and turbomolecular pump.	E 740							•	•	•	•		•		
	Replace the ball bearings and the seal of the ATP 100 or ATH 164 pump.	E 730									•			•	•	
	Complete maintenance of dry pump (ACP 28 pump/ACP 15 pump).	M ACP 28 TRM						•				•		•		
24000 h ⁽¹⁾ or 1 year ⁽³⁾	Replace the ball bearings and the seals of the molecular pump.	E 741	•		•	•	•	•								
500000 cycles	Change the valves.	E 530	•	•	•	•	•	•	•	•	•	•	•	•	•	•
Every 2 years	Change ATH 31 pump ball bearings if the leak detector has not been used.	M ATH 31 TRM		•												

*Service intervals: The service intervals given are for applications and work rates which conform to the normal operating conditions. If the machine is operating under more difficult conditions they can be shortened.

- (1) running time
- (2) running time or storage
- (3) storage

Maintenance message

Definition The Maintenance messages will be display on the LCD in order to inform the operator to do the maintenances. The operator should adjust the periodicity of the appearance of this message.

- These messages concern (according to the leak detector model):
- The primary pump
 - The high vacuum pump
 - The roughing pump
 - The periodicity of maintenance (cycles).

Adjustment of the counters

- All models
- - - ASM 142 / 182 T / 192 T / 1002
- · · · · ASM 122 D / 142 D / Graph D+ / 182 TD+ / 192 TD+
- - - - - ASM 192 T2
- ASM 192 T2D+

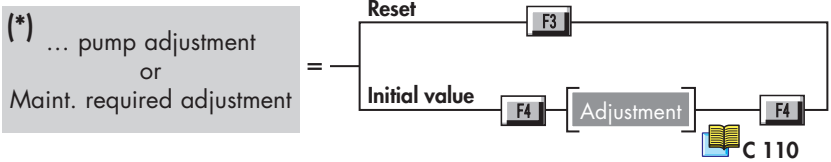
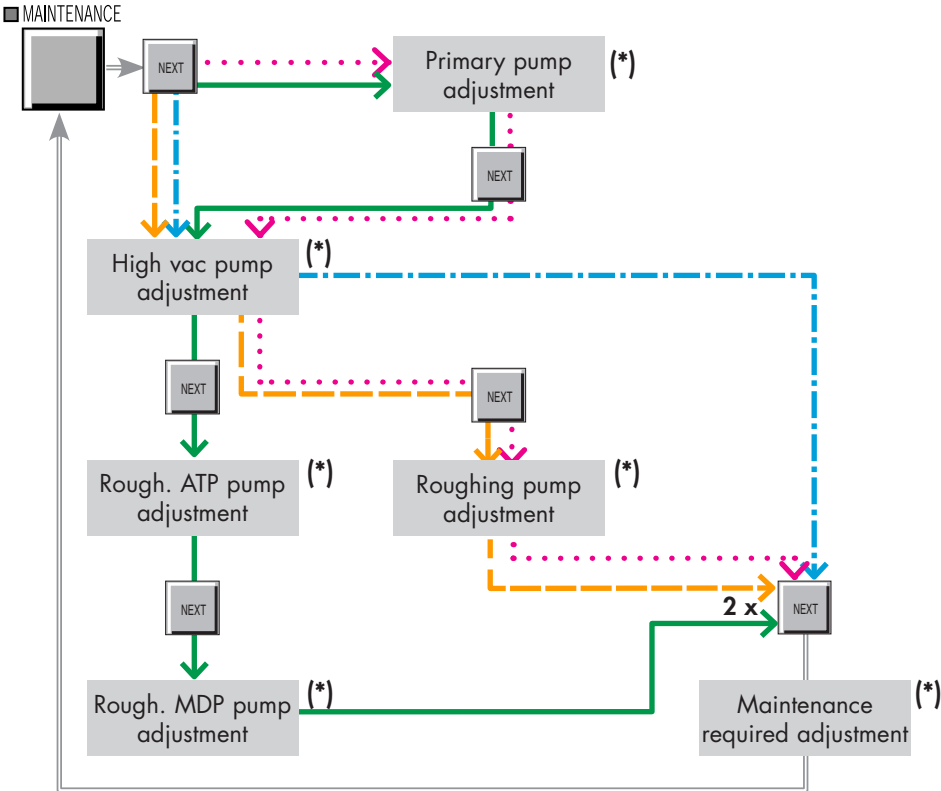

General troubleshooting guide

Remote control	
Helium signal or inlet pressure analog display abnormally lit	27
Remote Control keys inactive	28
Background	
High helium background signal	47
High helium background signal (in stand-by mode)	43
High helium background signal (in hard vacuum test mode)	44
Calibration	
autocal. aborted	3
autocal. required	2
Manual calibration	4
Start-up autocal. failure	31
Autocal. failure: cal. Leak year error	32
Autocal. failure: peak adjust error	37
Autocal. failure: peak locating error	36
Autocal. failure: emission loss	38
Autocal. failure: helium pollution	34
Unable to reach target value	40
Unable to start an autocalibration	39
Cell zero limits or Cell zero stability	35
Temperature too low/ high: autocal. failure temperature limits	33
Temperature too low/ high	51
Starting up	
No display appears on the control panel	42
Nothing happens when the power is switched ON	41

General troubleshooting guide

Message	
autocal. aborted	3
autocal. required	2
Manual calibration	4
New fil #1 / #2 required	5
Filament request off	6
Maintenance required	1
Control panel	
« ! « or « i « appears at the end of line 1 on the LCD	23
No display appears on the control panel	42
Helium signal or inlet pressure analog display abnormally lit	27
Helium signal digital display flashing	24
Password lost	25
Timekeeper ram fail.	26
Primary pump	
No noise from the rotary vane pump	55
Abnormal noise from the rotary vane pump	56
High vacuum pump	
Pump failure	52
Check the pump connection	54
Pump speed	53
Cell pressure	
Cell gauge failure	9
No cell pressure display	69
Cell pres. > 0.01 mbar	7
Cell pres. > 1e-04 mbar	8



General troubleshooting guide

Cell pressure	
Cell pressure safety	13
Triode safety	14
Inlet pressure	
Impossible to reach the selected mode	20
Inlet pressure display does not show atmospheric pressure	16
No inlet vent (inlet vent ON requested)	17
No test chamber opening at the cycle end Mode: asm	22
No test chamber opening at the cycle end Mode: pass/fail	21
No inlet pressure drop at start of a cycle	19
He signal	
High helium background signal (in stand-by mode)	43
High helium background signal (in hard vacuum test mode)	44
Emission failure	15
Fil 1/Fil 2 required	11
Filaments bad	10
No cell pressure display	69
No collector voltage	12
Helium signal unstable	45
Sniffing test	
High helium background signal	47
Inconsistent Helium signal	50
Helium signal unstable	48
Sniffer probe clogged	26
Temperature too low/ high	51

 General troubleshooting guide
Symptoms
D 400

Hard vacuum test	
High helium background signal (in stand-by mode)	43
High helium background signal (in hard vacuum test mode)	44
Impossible to reach the selected mode	20
No test chamber opening at the cycle end Mode: asm	22
No test chamber opening at the cycle end Mode: pass/fail	21
No test cycle start at the test chamber closing	46
Temperature too low/ high	51



General troubleshooting guide / Symptoms description

General troubleshooting guide ( D 300) and **Symptoms description** ( D 400) are available for consultation from an **INTERACTIVE** application specifically designed for the technical documentation.

To access to the
interactive application

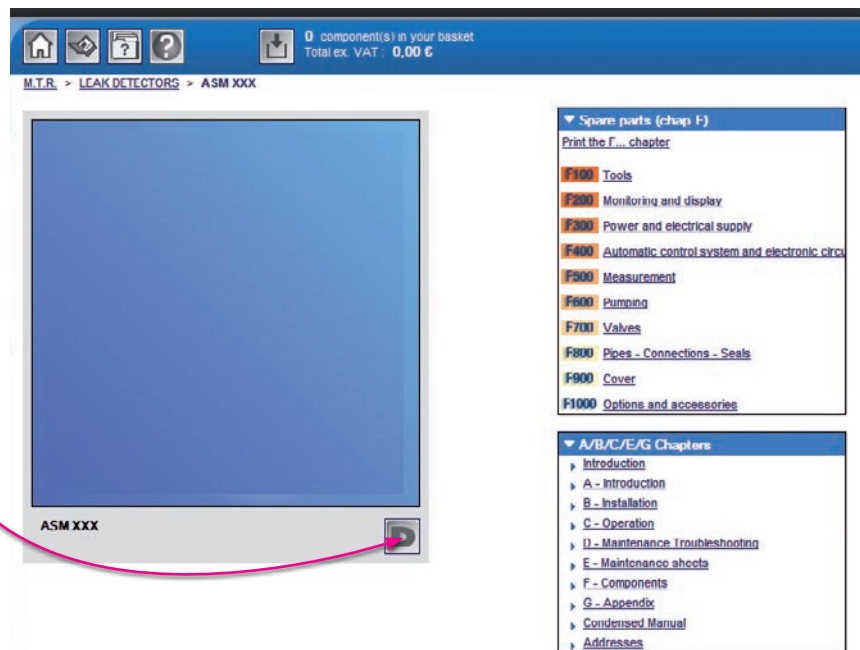
Click on the button
from the T.R.M.



To print the sheets
 D 300 and
 D 400

Display the sheet from the
pulldown menu and launch
the printing.

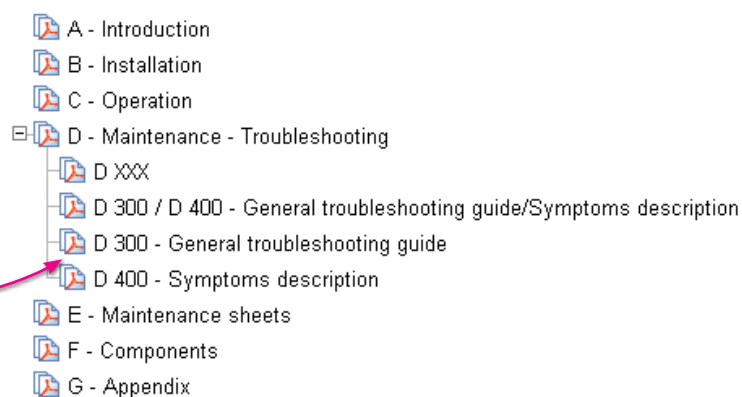

With the printing files, you lost all the easy research proposed with the application interactively. So we advise to use the interactive application for defaults and associated solutions research.

Symptoms description

SYMPTOM	ORIGIN / DIAGNOSTIC CONFIRMATION	REMEDY	
1 Maintenance required	Number of cycles before maintenance obsolete	<ul style="list-style-type: none"> Refer to the table of preventive maintenance intervals Reset the counter 	D 100 D 200
2 autocal. required	An autocalibration is required	<ul style="list-style-type: none"> Start an autocalibration 	C 301
3 autocal. aborted	The autocalibration is stopped before the end of the autocal. cycle	<ul style="list-style-type: none"> Restart an autocalibration 	C 301
4 Manual calibration	In spectro menu, autocal. is off	<ul style="list-style-type: none"> 	C 302
5 New fil #1 / #2 required	The fil #1 / #2 is burned	<ul style="list-style-type: none"> Change the fil #1 / #2 	E 400
6 Filament request off	The filament is switched off	<ul style="list-style-type: none"> In Spectro menu, switch on the filament 	E 400
7 Cell pres. > 0.01 mbar	Analyzer cell pressure too high / leak (spectro PI safety activated)	<ul style="list-style-type: none"> Check tightness of the analyzer cell Eliminate the leak 	-
8 Cell pres. > 1e-04 mbar	Analyzer cell pressure too high / leak (triode safety activated)	<ul style="list-style-type: none"> Keep pumping the cell for 10 min (in stand-by mode) If the trouble is not eliminated check tightness of the analyzer cell Eliminate the leak 	-
9 Cell gauge failure	Analyzer cell - spectro PI1 safety damage	<ul style="list-style-type: none"> Change or «Flash» the gauge. 	M -
10 Filaments bad	Both filaments broken	<ul style="list-style-type: none"> Replace filaments 	E 400
11 Fil 1/Fil 2 required	Short circuit in the cell (fil 1 / fil 2 collector shunt message)	<ul style="list-style-type: none"> Eliminate the short circuit in the cell 	E 400
12 No collector voltage	Supervisor board P0302 or P0320 board	<ul style="list-style-type: none"> Change the board E 230 	M E 230/E 310
13 Cell pressure safety	Analyzer cell pressure too high / leak or air inlet (spectro PI1 safety activated)	<ul style="list-style-type: none"> Keep pumping the cell for 10 min (in stand-by mode) If the trouble is not eliminated check tightness of the analyzer cell Eliminate the leak and check the state of the filaments 	-
14 Triode safety	Analyzer cell pressure too high / leak (triode safety activated)	<ul style="list-style-type: none"> Keep pumping the cell for 10 min (in stand-by mode) If the trouble is not eliminated check tightness of the analyzer cell Eliminate the leak and check the state of the filaments 	-

Symptoms description

SYMPTOM	ORIGIN / DIAGNOSTIC CONFIRMATION	REMEDY	
15 Emission failure	Filament off - During cycle, the calibration is defective	■ Check or replace the defective filament	E 400
16 Inlet pressure display does not show atmospheric pressure	Inlet port not vented (Inlet vent OFF on LCD)	■ Select Inlet Vent ON	C 500
17 No inlet vent (inlet vent ON requested)	Vent valve coil – Check valve VA1 connections and coil status	■ Change valve VA1 if faulty: - Minisol/bacosol - VAT: change valve if faulty	E 530/E 531
	Change supervisor board P0302	■ Exchange P0302	E 230
19 No inlet pressure drop at start of a cycle	Inlet gauge head disconnected	■ Secure proper inlet pirani gauge head connection	-
	Hard vacuum test cycle unauthorized (a sound is emitted when the cycle control key is pressed)	■ Check leak detector status: example: check that SNIFFING test is not selected	
	Fuse on the P0318 board defective (only 182/192 series)	■ Replace the fuse	
	Roughing valve VR1 defective Head gauge disconnected	■ Change the coil or the valve	
	Roughing valve not open (check valve coil status)	■ Check the valve coil and LED on supervisor board. Change VA1 valve according to status. Check the vacuum in the plastic buffer vacuum vessel	M -
20 Impossible to reach the selected mode	Leak detector configuration (Inlet pressure compatible with desired test mode)	■ Check selected test mode consistency	C 210
	Internal leak	■ Check the tightness of the valves, seals...	-
	Primary pump	■ Check primary pump limit pressure Repair if necessary If RVP, change the oil	
	Molecular or turbomolecular pump	■ Check the pump is rotating	
	Fuse on the P0318 board defective (only 182/192 series)	■ Replace the fuse	
	Detection valve defective	■ Change the coil or the valve	
21 No test chamber opening at the cycle end Mode: pass/fail	Part good, green light on	■ Check and set inlet vent parameters	C 500
22 No test chamber opening at the cycle end Mode: asm	Cycle and memo functions not active	■ Set functions	C 550/C 530
	Part good, green light on	■ Check and set inlet vent parameters	C 500
23 « ! » or « i » appears at the end of line 1 on the LCD	Fault or information display activated	■ Press NEXT to display the clear message	C 580

Symptoms description

SYMPTOM	ORIGIN / DIAGNOSTIC CONFIRMATION	REMEDY	
24 Helium signal digital display flashing	Fault display activated (Er alternately displayed with helium signal)	■ Press NEXT to display the clear message	C 580
25 Password lost	Impossible to access to the menus	■ Access to MAINTENANCE SPECIAL SERVICE MENU to display current password	M E 230
26 Timekeeper ram fail.	Supervisor board P0302 ram problem	■ Change the P0302 board	M E 230
26 Sniffer probe clogged	LDS probe filter clogged (message disappears when the filter is removed)	■ Change LDS probe filter	G 400
	Sniffer probe clogged set point adjustment too high (leak detector autocalibrated)	■ Check sniffer probe clogged set point value Adjust it 20 % of the ambient helium signal	
27 Helium signal or inlet pressure analog display abnormally lit	Wrong connection between remote control and control panel	■ Secure proper connection of the remote control, stop leak detector and start again	-
28 Remote Control keys inactive	Remote control disconnected (no LED and display on the remote)	■ Secure proper connection of the remote control. If remote control display is erratic, after reconnection, stop leak detector and start again	C 301
	Autocal key deactivated (Beep emitted when Autocal key is pressed)	■ Leak detector is in test mode: external calibration is available on the control panel only Stop test cycle to start an internal autocalibration	
31 Start-up autocal. failure	Filament status OFF	■ Select filament status ON in the spectro menu and start an autocal.	E 400
	Peak fault Analyzer cell incorrect assembly	■ Check the analyzer cell	
32 Autocal. failure: cal. Leak year error	Incorrect internal calibrated leak parameters	■ Check and correct internal calibrated leak parameters	C 305
33 Temperature too low/ high: autocal. failure temperature limits	Temperature sensor disconnected	■ Secure proper temp. captor connection to the internal calibrated leak	A 800
	Ambient temperature	■ Make sure the leak detector is used within ambient temperature tolerance	
	Fan(s) failure	■ Check fan status and replace faulty fan(s)	-

Symptoms description

SYMPTOM	ORIGIN / DIAGNOSTIC CONFIRMATION	REMEDY	
34 Autocal. failure: helium pollution	High background (helium signal is higher to the calibrated leak value used for the calibration)	<ul style="list-style-type: none"> Degassing in the analyzer cell: keep pumping the cell for 10 min (in stand-by mode) and start an autocalibration If the trouble is not eliminated, look for possible leaks or oil contamination (for RVP) 	E 750
35 Cell zero limits or Cell zero stability	VHS adjustment	<ul style="list-style-type: none"> Adjust the amplifier 	M E 418
	Electronic problem	<ul style="list-style-type: none"> Change the supervisor board or P0320 	M E 230/E 410
36 Autocal. failure: peak locating error	Problem of the calibration valve	<ul style="list-style-type: none"> Check valve VC3 	E 530
	Peak fault: internal calibrated leak damaged (lack of helium)	<ul style="list-style-type: none"> Check internal calibrated leak parameters Check consistency between measurement of the internal and the external calibrated leak 	C 300
		<ul style="list-style-type: none"> Change internal calibrated leak 	-
	Incorrect filament alignment	<ul style="list-style-type: none"> Check and adjust filament position 	E 400
	Peak fault: analyzer cell incorrect assembly	<ul style="list-style-type: none"> Check the analyzer cell 	
37 Autocal. failure: peak adjust error	Peak fault: internal calibrated leak parameters	<ul style="list-style-type: none"> Check that the calibration parameters are correct 	E 400
	Incorrect filament alignment	<ul style="list-style-type: none"> Check and adjust filament position 	
	Peak fault: analyzer cell incorrect assembly	<ul style="list-style-type: none"> Check the analyzer cell 	E 530
38 Autocal. failure: emission loss	Problem of the calibration valve	<ul style="list-style-type: none"> Check valve VC3 	C 302
39 Unable to start an autocalibration	Manual calibration selected	<ul style="list-style-type: none"> Select automatic calibration 	C 302
	Leak detector is in test mode (remote control AUTOCAL key inactive)	<ul style="list-style-type: none"> The control panel AUTOCAL key is only active to start an external calibration For internal autocalibration, stop the test cycle 	C 301
40 Unable to reach target value	Incorrect internal calibrated leak parameters	<ul style="list-style-type: none"> Check and correct internal calibration leak parameters 	C 305
	Calibrated leak valve cal-det not open	<ul style="list-style-type: none"> Check valve coil and/or LED on the supervisor board. Change valve. 	M -
	Internal calibrated leak faulty (check helium signal with an external calibrated leak)	<ul style="list-style-type: none"> Change/recalibrate internal calibrated leak 	E 560
41 Nothing happens when the power is switched ON	Power fuse burnt	<ul style="list-style-type: none"> Change fuse and check power voltage 	-

Symptoms description

SYMPTOM	ORIGIN / DIAGNOSTIC CONFIRMATION	REMEDY	
42 No display appears on the control panel	Control panel disconnected from supervisor board	■ Secure proper control panel connection.	-
	Power supply board trouble	■ Change fuse of the power supply board	
	Control panel trouble	■ Change control panel board	
	Power supply board trouble	■ Change fuse of P0330 or change board. ■ Check power voltage supply through Supervisor board LEDs	M E200 M E230
43 High helium background signal (in stand-by mode)	Rotary vane pump pollution (if RVP)	■ Open air ballast Change the oil	E 750
	Leak inside the leak detector	■ Helium leak: check the valves	-
	Analyzer cell contamination	■ Clean and recondition the cell	E 400
	Ambient air helium contamination (background OK when leak detector placed in another room or environment, free of helium contamination)	■ Clean the ambient air	-
44 High helium background signal (in hard vacuum test mode)	Tested piece degassing (background OK in test mode when leak detector inlet port blanked off)	■ Clean the part/installation being testing. Eliminate the source of degassing or contamination	-
45 Helium signal unstable	Analyzer cell connections	■ Check that the external analyzer cell connections are correct and the internal analyzer cell connections properly fastened	-
	Contamination of the rotary vane pump oil (helium "peaks" at regular intervals) (if RVP)	■ Change the oil	E 750
	Faulty VHS amplifier	■ Change the analyzer cell or the faulty component.	M E 400
46 No test cycle start at the test chamber closing	Sensor disconnected: sensor light off	■ Check the sensor connection to the test chamber and the board	-
47 High helium background signal	Ambient air helium contamination (background OK when leak detector placed in another room or environment, free of helium contamination)	■ Clean ambient air	-
	Internal LDS plastic tube disconnected (background decreases very slowly when sniffer probe tip is blocked with a finger)	■ Repair LDS probe tube (tightness of connectors) or change LDS probe	G 400
48 Helium signal unstable	Ambient source of helium contamination	■ Check possible sources of helium emission in the surroundings Eliminate or isolate it	-

Symptoms description

SYMPTOM	ORIGIN / DIAGNOSTIC CONFIRMATION	REMEDY	
50 Inconsistent Helium signal	Fine signal adjustment required	<ul style="list-style-type: none"> Make an external calibration in sniffing mode 	C 303
51 Temperature too low/ high	Ambient temperature sensor	<ul style="list-style-type: none"> Make sure the leak detector is used within ambient temperature tolerance 	A 800
52 Pump failure	Overheating	<ul style="list-style-type: none"> Check the connections : unplug and plug the cables on the P0326 board and the pump If the pump isn't locked at starting, the orange led on the P0326 lights on after the simultaneous lighting of the 3 leds during 3-4 seconds. Recondition the pump or replace it. 	- E 740/E 747
	Mechanical hard spot (does not spin freely by hand)	<ul style="list-style-type: none"> If the pump is locked at starting, the red led on the P0326 lights on after the simultaneous lighting of the 3 leds during 3-4 seconds. 	M -
53 Pump speed	P0326 switch is in running in	<ul style="list-style-type: none"> 	-
	The exhaust pressure of the pump is not correct (lower or equal to 5 mbar)	<ul style="list-style-type: none"> Check the pump 	
	The exhaust valve has not opened	<ul style="list-style-type: none"> Check the gross leak valve 	E 740
	Leaks inside the leak detector	<ul style="list-style-type: none"> Check the tightness of the canalizations, valves, pumps and cell (alcohol test or use of another detector) 	-
	Greasing of the pump ball bearings to be performed	<ul style="list-style-type: none"> Regrease the pump ball bearings 	E 740
	Mechanical hard spot (does not spin freely by hand)	<ul style="list-style-type: none"> Replace the turbomolecular pump or recondition the pump 	M -
54 Check the pump connection	Pump is not connected with pump controller board P0326	<ul style="list-style-type: none"> Check the cable. Unplug and replug the cables on the P0326 and pump 	M -
55 No noise from the rotary vane pump	Rotary vane pump power supply not connected	<ul style="list-style-type: none"> Connect the rotary vane pump power supply connector 	-
	Impossible to keep in position 1 circuit breaker switch of the rotary vane pump	<ul style="list-style-type: none"> 	M UM RVP
	Motor thermistor Internal motor temperature higher to 60°C	<ul style="list-style-type: none"> Allow the pump to cool down 	
56 Abnormal noise from the rotary vane pump	Oil temperature lower than 10°C	<ul style="list-style-type: none"> Heat the pump body to approximately 18°C 	-
	Symptoms of seizure: the motor binds (heats up)	<ul style="list-style-type: none"> Repair the RVP pump 	M UM RVP

Symptoms description

SYMPTOM	ORIGIN / DIAGNOSTIC CONFIRMATION	REMEDY	
69 No cell pressure display	Test crossover pressure too high (trouble during hard vacuum test)	<ul style="list-style-type: none"> ■ Check/adjust P11 inlet gauge on the supervisor board 	M E 510
	Filament OFF requested	<ul style="list-style-type: none"> ■ Check filament status in SPECTRO menu 	-
	Short circuit on triode electrode	<ul style="list-style-type: none"> ■ Eliminate the short circuit in the cell 	