

CUSTOMER PRINT

PART NUMBER: 6282-XPG-3XX(CCX)

- NOTES:**
1. ALL PARTS TO BE BULK PACKED.
 2. CONTACTS ASSEMBLED INTO CONNECTOR.
 3. SEE DRAWING HPMISTD FOR HOLE PATTERN.

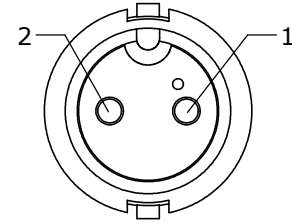

FACE VIEW
6282-2PG-3DC
6282-2PG-3XX

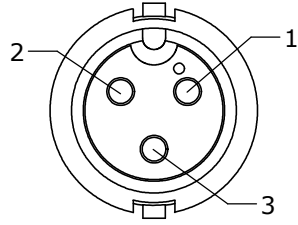

FACE VIEW
6282-3PG-3DC
6282-3PG-3XX

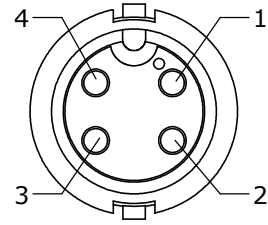

FACE VIEW
6282-4PG-3DC
6282-4PG-3XX

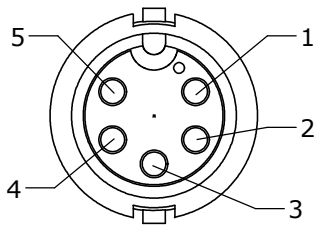

FACE VIEW
6282-5PG-3DC
6282-5PG-3XX

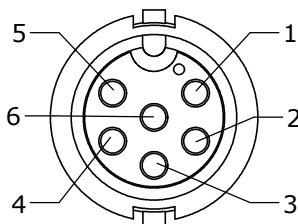

FACE VIEW
6282-6PG-3DC
6282-6PG-3XX

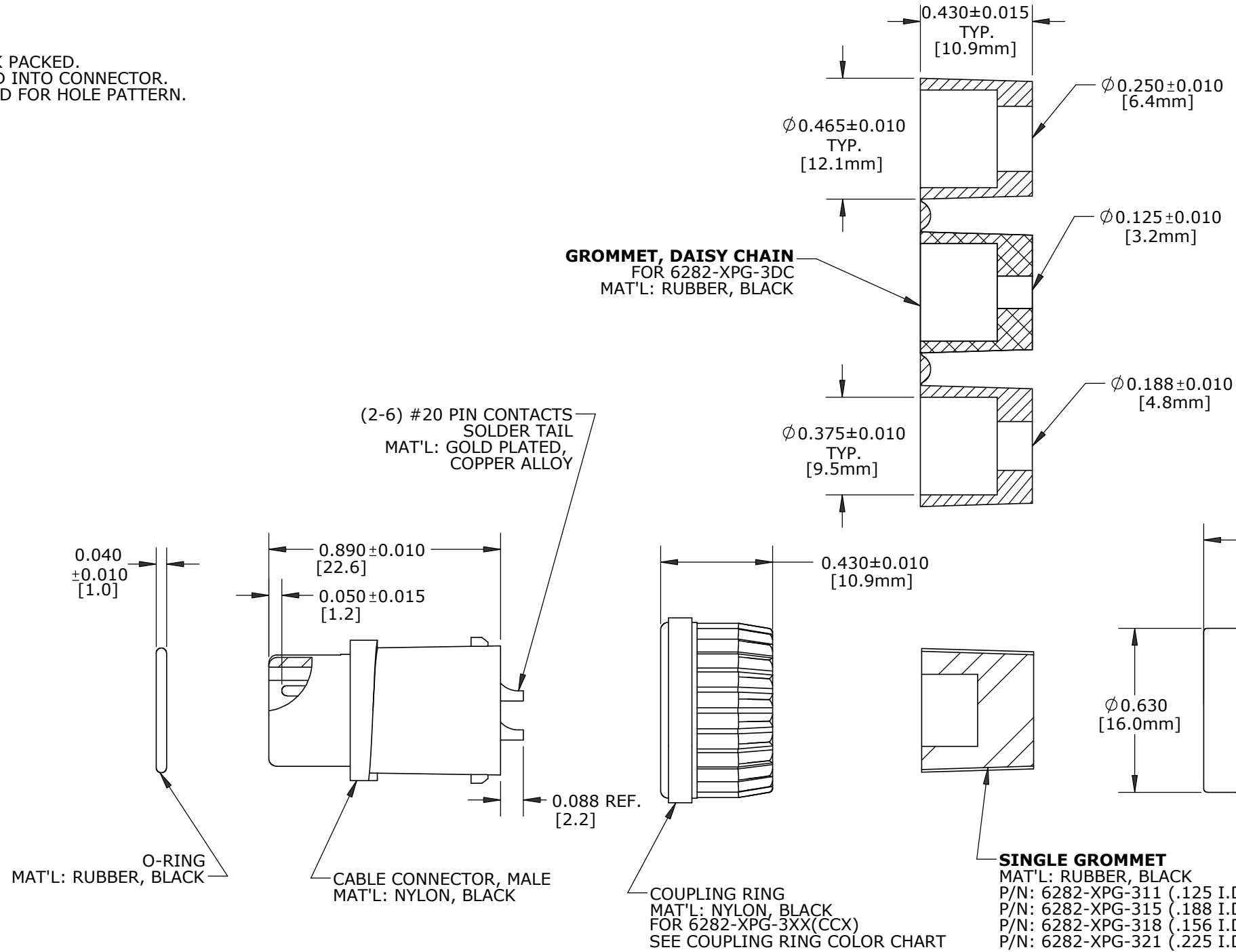

ASSY P/N	NO. OF CONTACTS	GROMMET
6282-2PG-3DC	2 #20	DAISY CHAIN
6282-3PG-3DC	3 #20	DAISY CHAIN
6282-4PG-3DC	4 #20	DAISY CHAIN
6282-5PG-3DC	5 #20	DAISY CHAIN
6282-6PG-3DC	6 #20	DAISY CHAIN
6282-2PG-3XX	2 #20	SINGLE GROMMET
6282-3PG-3XX	3 #20	SINGLE GROMMET
6282-4PG-3XX	4 #20	SINGLE GROMMET
6282-5PG-3XX	5 #20	SINGLE GROMMET
6282-6PG-3XX	6 #20	SINGLE GROMMET
6282- PG-3		

GROMMET SIZE FOR SINGLE GROMMET (SEE LIST) OR "DC" FOR DAISY CHAIN

NO. OF CONTACTS

ASS'Y P/N	COUP. RING COLOR
6282-XPG-3XXCC1	WHITE
6282-XPG-3XXCC2	RED
6282-XPG-3XXCC3	BLUE
6282-XPG-3XXCC4	LIGHT GREY
6282-XPG-3XXCC5	YELLOW
6282-XPG-3XXCC6	MAROON
6282-XPG-3XXCC7	GREEN

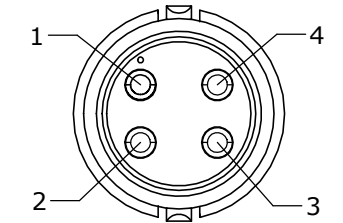

WIRE VIEW
6282-3PG-3XX SHOWN

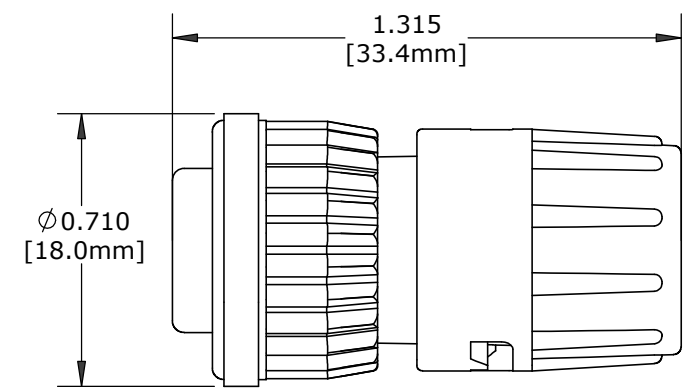

DIMENSIONS IN BRACKET [] ARE METRIC.

CUSTOMER APPROVAL

THIS DOCUMENT CONTAINS CONFIDENTIAL INFORMATION PROPRIETARY TO CONXALL CORPORATION. ANY REPRODUCTION, DISCLOSURE, OR USE OF THIS DOCUMENT /INFORMATION IS EXPRESSLY PROHIBITED UNLESS AUTHORIZED IN WRITING BY CONXALL CORPORATION.

APPROVED BY: _____

DATE: _____

RoHS COMPLIANT

F	SS	07-21-20	ADDED COUPLING RING COLOR CHART PER DOR 20-E149SL #24
E	SS	01-07-20	CHANGED DIM 0.068 TO 0.088 AND 0.046 TO 0.050 PER ECR 8178 RELEASE #46
D	PD	02-01-12	UPDATE MANUFACTURING DRAWING PER ECR 8020
C	AN	02-17-11	ADDED 6282-2PG-3DC & 6282-2PG-3XX TO CHART, CORRECTED POS. CALL-OUT ON 3 POS FACE VIEW, ADDED DAISY CHAIN GROMMET VIEW, REDRAWN IN SOLIDWORKS. PER ECR 7770
B	RCS	05-07-03	ADD ASS'Y P/N 6282-6PG-3DC, 6282-6PG-3XX & 6 POS FACE VIEW. PER DOR #03-4091KZ
A	RCS	06-19-01	DRAWING CREATED PER DOR #01-2081JS
REV:	INIT:	DATE	DESCRIPTION
ALL INFORMATION ILLUSTRATED IS THE PROPERTY OF CONXALL CORPORATION. UNAUTHORIZED DUPLICATION OR DISTRIBUTION OF THIS DOCUMENT IS PROHIBITED.		ORIG. DRAWN BY: RCS	DATE: 06-18-01
ALL UNITS ARE IN FEET, INCHES, FRACTION OF INCHES AND DECIMALS.		CHECKED BY:	
		APPROVED BY:	
SCALE: NTS	SIZE: B	SHEET: 1 OF 1	TITLE: CONNECTOR ASSEMBLY 2-6 #20 PIN CONTACTS, SOLDER TAIL MINI-CON-X
FILE: 6282-XPG-3XX(CCX)	DIRECTORY: SLW	PART NUMBER: 6282-XPG-3XX(CCX)	CUSTOMER: STANDARD PRODUCT
- CRITICAL CHARACTERISTIC FLAG PER SPEC. XXXX			REV: F



601 E. WILDWOOD VILLA PARK, IL 60181