

Controller

RVC 300

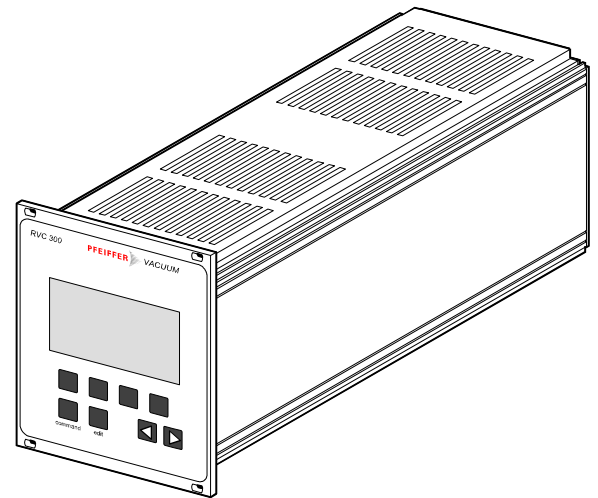

Product Identification

In all communications with Pfeiffer Vacuum, please specify the information on the product nameplate. For convenient reference copy that information into the nameplate replica below:

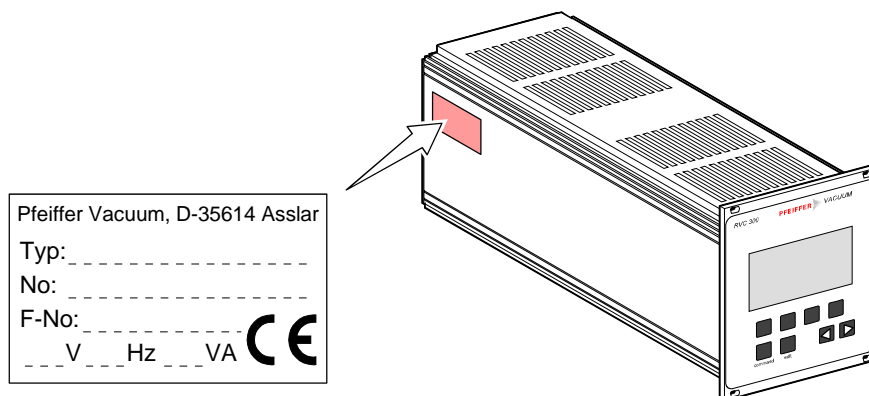

Validity

This document applies to products with part number
PFI00792

The part number can be taken from the product nameplate.

This document is based on firmware version 2.1X.

If your unit does not work as described in this document, please check that it is equipped with the above firmware number (→ 20).

We reserve the right to make technical changes without prior notice.

Intended Use

The RVC 300 Pressure Controller is used for pressure control or gas flow adjustment in a vacuum system. An overview of the operating modes and possible vacuum system configurations is given on 6.



The RVC 300 has been designed for incorporation into a 19" rack chassis.

Scope of Delivery

- 1 Controller RVC 300
- 4 collar screws with plastic sleeves for rack installation
- 1 power cord (country-specific), 2 m
- 1 digital IN/OUT cable connector (D-Sub, 25-pole, female)
- 1 analog IN/OUT cable connector (D-Sub, 15-pole, male)
- 1 Operating Manual BG 805 280 BE / C including Declaration of Conformity

Contents

Product Identification	2
Validity	2
Intended Use	2
Scope of Delivery	2
1 Safety	4
1.1 Symbols Used	4
1.2 Personnel Qualifications	4
1.3 General Safety Instructions	5
1.4 Liability and Warranty	5
2 Design and Functional Principle	6
2.1 Overview	6
2.2 Operating Modes	6
3 Technical Data	9
4 Installation	12
4.1 Personnel	12
4.2 Rack Installation	12
4.3 Mains Power Connection	13
4.4 Valve Connection	14
4.5 Pressure Sensor	15
4.6 Digital Inputs/Outputs	16
4.7 Analog Inputs/Outputs	18
4.8 RS232 and RS485 Serial Interfaces	19
5 Turning the RVC 300 On and Off	20
6 Configuration	23
6.1 Display Contrast	25
6.2 Measurement Unit of the Pressure	26
6.3 Language	27
6.4 Automatic Booting Function	28
6.5 Automatic Reset Function	29
6.6 Operating Mode	30
6.7 Valve	31
6.8 Control Mode	32
6.9 Pressure Sensor	33
6.10 Digital Inputs	35
6.11 Digital Outputs	36
6.12 Analog Inputs/Outputs	39
6.13 Serial Interface	40
7 Operation Via Keys	41
7.1 Pressure Control	42
7.2 Gas Flow Adjustment	47
8 Operation Via Inputs and Outputs	50
9 Operation Via Serial Interface	52
10 Maintenance	60
11 Repair	61
12 Returning the Product	61
13 Accessories	62
14 Storage	63
15 Disposal	63
Appendix	64
A: Implemented Pressure Sensors	64
B: Conversion Tables	65
C: Literature	65
Declaration of Conformity	67

For cross-references within this document, the symbol (→  XY) is used, for cross-references to further documents, listed under literature, the symbol (→  [Z]).

1 Safety

1.1 Symbols Used

DANGER

Information on preventing any kind of physical injury.



WARNING

Information on preventing extensive equipment and environmental damage.

Caution

Information on correct handling or use. Disregard can lead to malfunctions or minor equipment damage.

 Practical advice, tip, recommendation

 Waiting time, response time

→  See page ...

<....> Labeling

1.2 Personnel Qualifications

Skilled personnel

All work described in this document may only be carried out by persons who have suitable technical training and the necessary experience or who have been instructed by the end-user of the product.

1.3 General Safety Instructions

Adhere to the applicable regulations and take the necessary precautions for all work you are going to do and consider the safety instructions in this document.

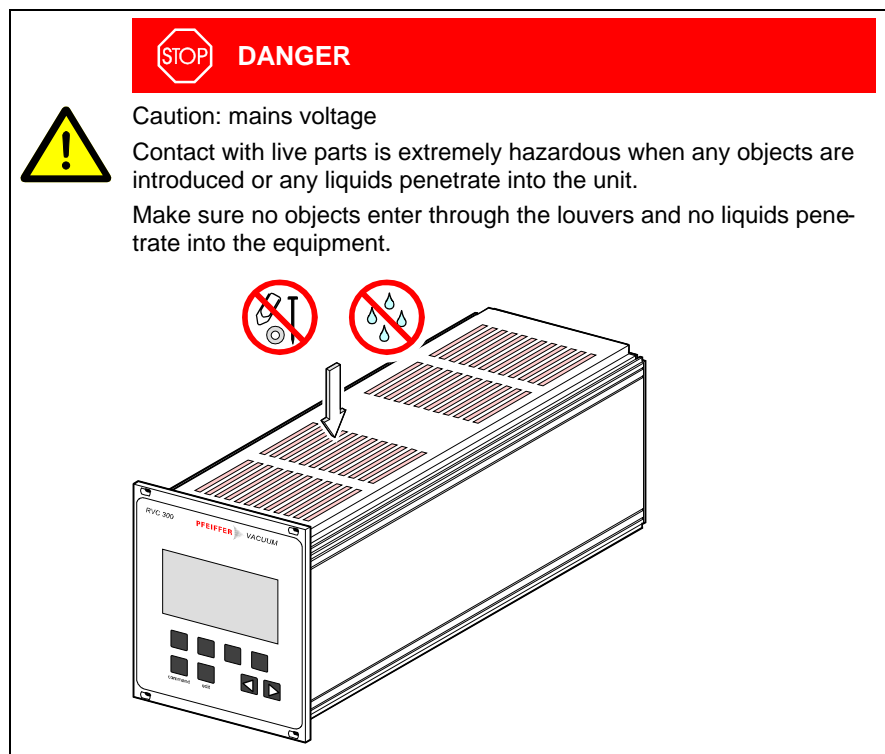

Communicate the safety information to all other users.

1.4 Liability and Warranty

Pfeiffer Vacuum assumes no liability and the warranty becomes null and void if the end-user or third parties

- disregard the information in this document
- use the product in a non-conforming manner
- make any kind of interventions (modifications, alterations etc.) on the product
- use the product with accessories, options, and add-ons not listed in the corresponding product documentation.

The end-user assumes the responsibility in conjunction with the process media used.

2 Design and Functional Principle

2.1 Overview

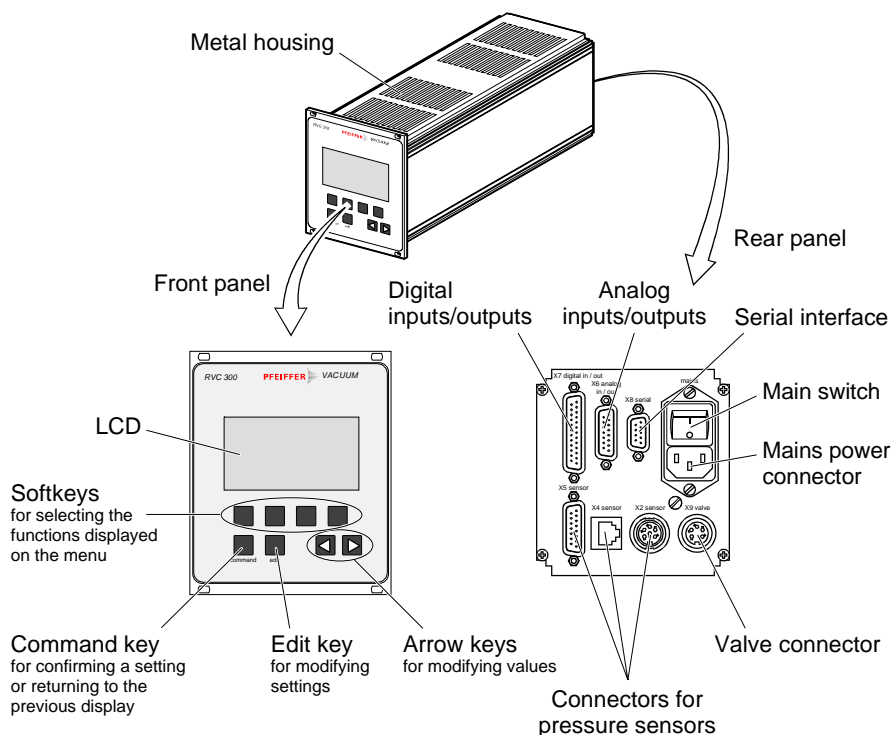

2.2 Operating Modes

The RVC 300 works in the following operating modes:

- Pressure (pressure control mode)
- Flow (gas flow adjustment mode)

Pressure control (Pressure)

This operating mode is used for controlling the pressure in a vacuum system either with a variable gas flow (upstream control) or with a variable conductance (downstream control). Any of the implemented gauges (→ 64) or another appropriate pressure sensor and a suitable control valve are required for this mode.

The pressure sensor supplies a continuous pressure signal (0 ... +10 VDC) to the RVC 300. The RVC 300 compares the pressure signal (actual value) with the nominal pressure and controls the control valve in a way which compensates for the dynamic characteristics of the controlled process. This means that the actual value should attain the setpoint (nominal value) as rapidly as possible and then fluctuate as little as possible about it. The setpoint (nominal value) can be entered manually on the Pressure Controller or provided by an external control system.

Control modes

The RVC 300 can be operated in two control modes:

STD: Pressure control with variable gas flow (upstream control):
The control valve regulates the gas inlet of the vacuum system. The valve plate moves in closing direction when the pressure in the vacuum system rises.

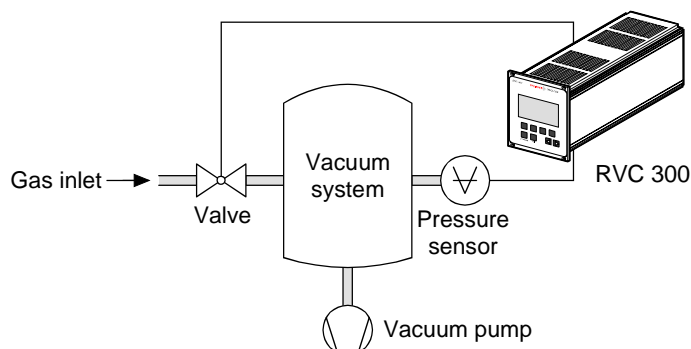

INV: Pressure control with variable conductance (downstream control):
The control valve regulates the pumping speed of the vacuum system. The valve plate moves in opening direction when the pressure in the vacuum system rises.

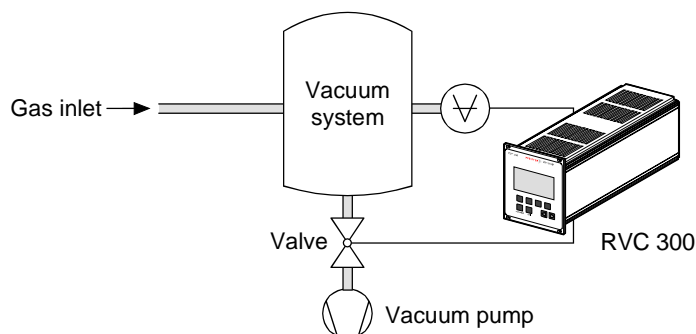

Controller types

The RVC 300 features two controller types:

Auto: Auto is a PI (proportional/integral) controller type working with control speeds 1 ... 99 (1 = slow, 99 = fast). This controller type is used for fast optimization of the process.

PID: The gain (K_p), reset time (T_n), and derivative time (T_v) of the PID (proportional/integral/derivative) controller type are user-definable. The PID controller is used when good control to a setpoint (nominal value) combined with a fast response is required.

Gas flow adjustment (Flow)

This operating mode is used for gas flow adjustment in a vacuum system (up-stream control). The EVR 116 or RME 005 Control Valve is required for this mode.

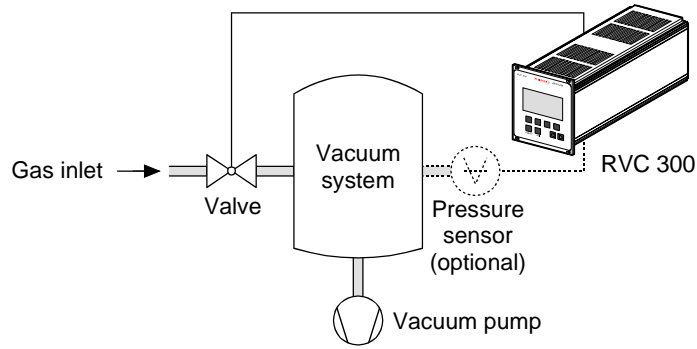

The gas flow setting is made on the RVC 300 and results in a corresponding gas flow rate through the control valve used at a pressure difference Δp of 1 bar. The flow rate curve depends on the control valve used. The curves shown in the following diagrams correspond to a mean value for air at a pressure difference Δp of 1 bar.

Flow rate curve for EVR 116

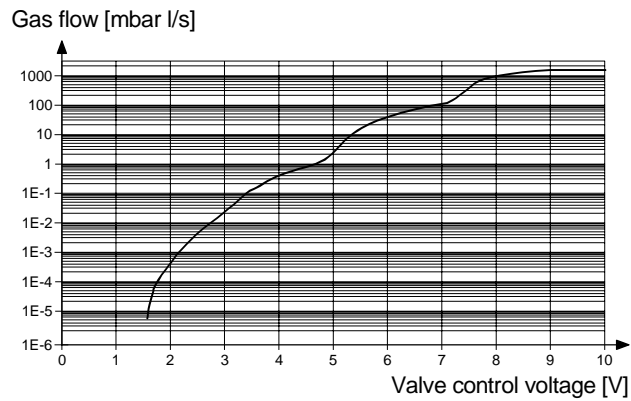

Flow rate curve for RME 005

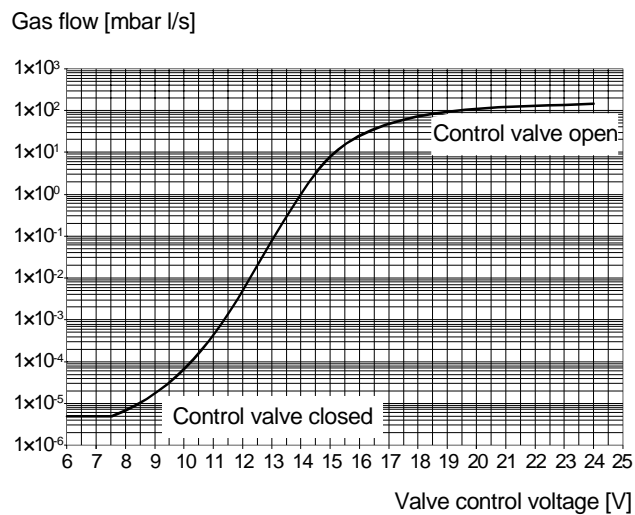

3 Technical Data

Mains specifications	Mains voltage	90 ... 250 VAC, 50/60 Hz	
	Power consumption	50 VA	
	Overvoltage category	II (EN 61010-1)	
	Protection class	I (EN 61010-1)	
	Main switch	On the rear of the RVC 300	
Controller	Controller types	1 ... 99 (1 = slow, 99 = fast)	
	Auto (PI) adjustable	Gain Kp: 0.1 ... 100.0	
	PID adjustable	Reset time Tn: 0.0 ... 3600.0 s	
		Derivative time Tv: 0.0 ... 3600.0 s	
	Control accuracy ¹⁾	0.5 % F.S.	
	Scan rate of pressure sensors	<100 ms	
	Update rate		
	Inputs/outputs	<100 ms	
	RME 005	<100 ms	
	EVR 116	<500 ms	
Display	Display	LCD 64x128 pixel	
	Measurement units (selectable)		
	Pressure	mbar, Torr, Pa, mV	
	Flow	mbar l/s, Torr l/s, Pa l/s, mV	
	Display range ^{2) 3)}		
	Pressure	with TPR 261	5.00E-04 mbar ... 1.00E+03 mbar
		with TPR 265	5.00E-04 mbar ... 1.00E+03 mbar
		with IKR 251	2.00E-09 mbar ... 1.00E-02 mbar
		with IKR 261	2.00E-09 mbar ... 1.00E-02 mbar
		with PKR 251	5.01E-09 mbar ... 1.00E+03 mbar
	with PKR 261	5.01E-09 mbar ... 1.00E+03 mbar	
	with APR 250	1.00E+00 mbar ... 1.10E+03 mbar	
	with APR 260	1.00E+00 mbar ... 1.10E+03 mbar	
	with CMR 261	1.00E+00 mbar ... 1.10E+03 mbar	
	with CMR 262	1.00E-01 mbar ... 1.10E+02 mbar	
	with CMR 263	1.00E-02 mbar ... 1.10E+01 mbar	
	with CMR 264	1.00E-03 mbar ... 1.10E+00 mbar	
	with CMR 271	1.00E+00 mbar ... 1.10E+03 mbar	
	with CMR 272	1.00E-01 mbar ... 1.10E+02 mbar	
	with CMR 273	1.00E-02 mbar ... 1.10E+01 mbar	
	with CMR 274	1.00E-03 mbar ... 1.10E+00 mbar	
	with CMR 275	1.00E-04 mbar ... 1.10E-01 mbar	
	with IMR 265	1.00E-06 mbar ... 1.00E+03 mbar	
	with PBR 260 ⁴⁾	5.01E-10 mbar ... 1.00E+03 mbar	
	with 0 ... 10 V lin	0 ... 10000 mV	
	Flow		
	with EVR 116	Closed, 5.00E-06 ... 1.25E+03 mbar l/s	
	with RME 005	Closed, 1.00E-05 ... 1.00E+02 mbar l/s	
	with AO 2 ⁵⁾	0 ... 10000 mV	

¹⁾ Valid for sensor setting 0 ... +10 V lin and output AO 2.

²⁾ Pressure readings in mbar; readings in Torr or Pa → conversion table 65 or display of Pressure Controller (Selection of measurement unit → 26).

³⁾ As the products of Pfeiffer Vacuum are subject to continual development, new pressure sensors may have been implemented in your RVC 300 Pressure Controller.

⁴⁾ The degas function of the PBR 260 is not supported by the RVC 300.

⁵⁾ The 0 ... +10 VDC analog output AO 2 can be used for controlling valves other than the EVR 116 and RME 005.

Digital inputs	Digital inputs ¹⁾ DI 1 DI 2 DI 3 DI 4 DI 5 DI 6 DI 7 DI 8	(8 channels) Flow decrease Flow increase External CLOSE External OPEN Flow mode Pressure mode Emission ON Degas ON
	Voltage Current Signal level ON OFF	+24 VDC (external) <2.5 mA +15 ... 33 VDC ≤+5 VDC
Digital outputs	Digital outputs ²⁾ DO 1 DO 2 DO 3 DO 4 DO 5 DO 6 DO 7 DO 8	(8 channels) Valve closed Valve open Valve in position Valve error Sensor error ready Emission ON Sensor status
	Digital output parameters ³⁾ DO 3 Deviation Signal ON Signal OFF ON-delay	0.1% ... 50.0% F.S. of pressure sensor 0.1% ... 50.0% F.S. of pressure sensor 0 ... 999 s
	Voltage Current	+24 VDC 1 output max. 100 mA The current of all outputs together must not exceed 150 mA!
Analog inputs	Analog inputs ⁴⁾ AI 1 AI 2 AI 3 AI 4	(2 channels) Pressure setpoint (nominal value) Flow setpoint (nominal value) Not used Not used
	Voltage range Internal resistance	0 ... +10 VDC 40 kΩ
Analog outputs	Analog outputs ⁵⁾ AO 1 AO 2 ⁶⁾ AO 3 AO 4	(4 channels) Pressure sensor signal Valve signal (0 ... +10 VDC) Valve position EVR 116 +10 VDC reference voltage (10 mA)
	Voltage range Load resistance	0 ... +10 VDC ≥2 kΩ
Serial interface	Types ⁷⁾ Transmission rate Data bits Stop bits Parity bit	RS232, RS485 9600 baud 8 1 0 (none)

¹⁾ For information on wiring → 17, on configuration → 35, on operation → 50.

²⁾ For information on wiring → 17, on configuration → 36, on operation → 50.

³⁾ For explanation and information on configuration → 37.

⁴⁾ For information on wiring → 18, on configuration → 39, on operation → 51.

⁵⁾ For information on wiring → 18, on configuration → 39, on operation → 51.

⁶⁾ The 0 ... +10 VDC analog output AO 2 can be used for controlling valves other than the EVR 116 and RME 005.

⁷⁾ For information on wiring → 19, on configuration → 40, on operation → 52.

Ambience

Temperature operation	+5 ... 50 °C
Temperature storage	-40 ... 60 °C
Relative humidity	≤80% up to +31 °C decreasing to 50% at +40 °C
Use	Indoors only Max. altitude 2000 m NN
Pollution degree	2 (EN 61010-1)
Degree of protection	IP 30 (EN 60529)

Dimensions [mm]

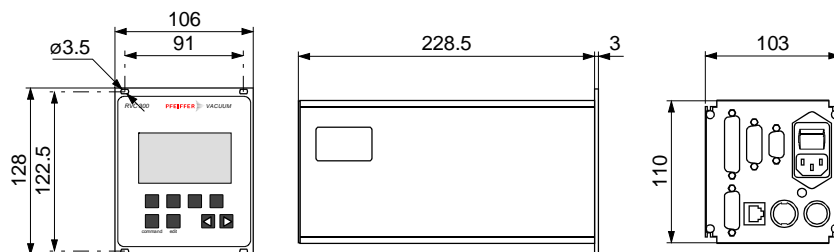

Weight

1.65 kg

4 Installation

4.1 Personnel



Skilled personnel



The RVC 300 may only be installed by persons who have suitable technical training and the necessary experience or who have been instructed by the end-user of the product.

4.2 Rack Installation



DANGER



Caution: damaged product

Putting a damaged product into operation can be extremely hazardous.

In case of visible damage make sure the product is not put into operation.

The RVC 300 is designed for installation into a 19" rack chassis (height 3 U, depth 21 U according to DIN 41 494).



DANGER



Caution: protection category of the rack

If the product is installed in a rack, it is likely to lower the protection category of the rack (protection against foreign bodies and water) e.g. the EN 60204-1 regulations for switch cabinets.

Take appropriate measures for the rack to meet the specifications of the protection category.

Slide the RVC 300 into a 19" rack chassis and fasten it with the supplied four collar screws and plastic sleeves.

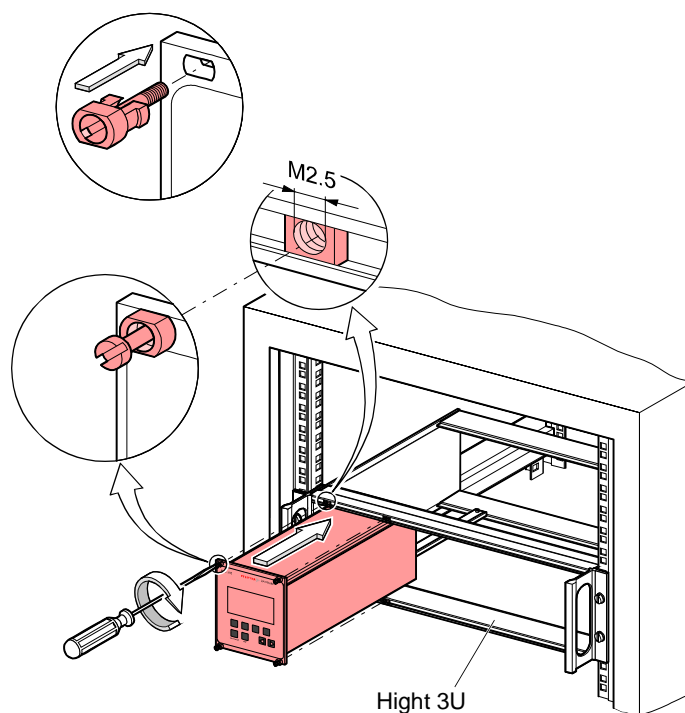

4.3 Mains Power Connection

STOP DANGER



Caution: line voltage

Incorrectly grounded products can be extremely hazardous in the event of a fault.

Use only a 3-conductor power cable with protective ground. The power connector may only be plugged into a socket with a protective ground. The protection must not be nullified by an extension cable without protective ground.

The unit is supplied with a 2 m power cord. If the mains cable is not compatible with your system, use your own, suitable cable with protective ground.

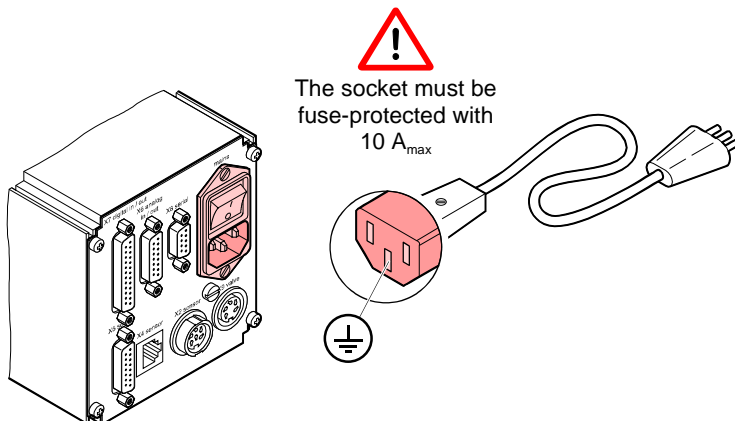

The mains voltage should be supplied and turned on via a central power distributor because the main switch of the RVC 300 cannot be reached from the front.

4.4 Valve Connection



The «X9 valve» receptacle is configured especially for the EVR 116 and RME 005 Control Valves. For controlling valves other than the EVR 116 and RME 005, the 0 ... +10 VDC analog output AO 2 must be used (Pin assignment → 18).

EVR 116

Connect the EVR 116 Control Valve to the «X9 valve» receptacle (EVR 116 and connection cable → 62, Operating Instructions → [1]).

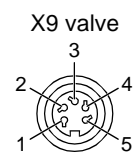
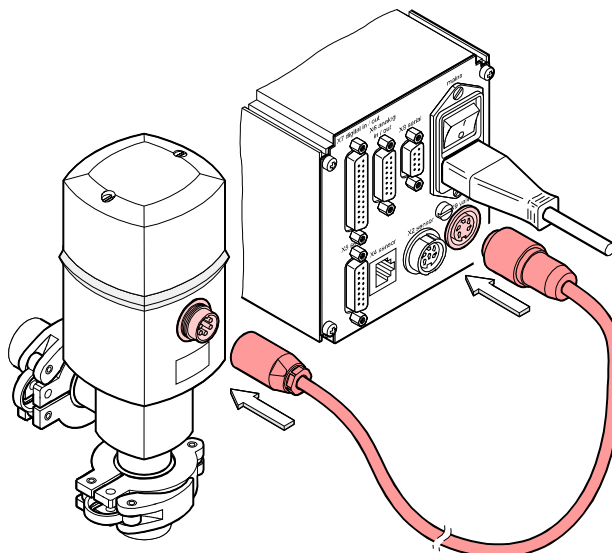

Signal	Pin
SIO	1
GND	2
ANOUT+	3 (not used)
ANOUT-	4 (not used)
24VDC	5

RME 005

Connect the RME 005 Control Valve to the «X9 valve» receptacle (RME 005 and connection cable → 62, Operating Instructions → [2]).

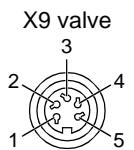
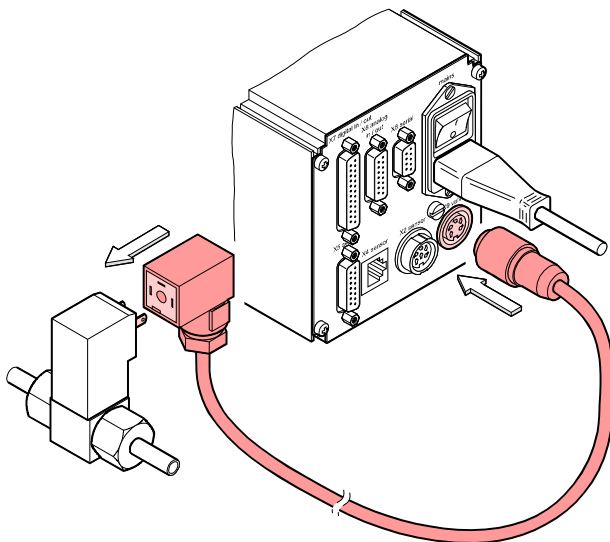

Signal	Pin
SIO	1 (not used)
GND	2 (not used)
ANOUT+	3
ANOUT-	4
24VDC	5 (not used)

4.5 Pressure Sensor



Caution



Caution: malfunctions

Connecting more than one pressure sensor at a time may cause malfunctions.

Connect only one sensor at a time.

The RVC 300 is equipped with three different sensor receptacles (compatible pressure sensors → 64).

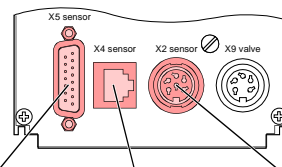

X5: D-Sub15-pole X4: FCC68 8-pole X2: DIN 6-pole

Pin assignment

DIN receptacle

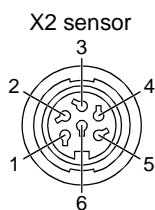

Designation	Signal	Pin
Identification ^{1) 2)}		1
Supply common	GND	2
Signal input	0 ... +10 VDC	3
Signal common	GND	4
Shielding	GND	5
Supply	+24 VDC	6

¹⁾ The identification information of the sensors is not processed by the RVC 300.

²⁾ On the PPR 260, this pin is also used to control the the sensor's degas function. Degas of the PPR 260 is not supported by the RVC 300.

X5 D-Sub receptacle

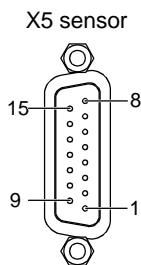

Designation ³⁾	Signal	Pin
Emission status input	+24 VDC	1
Signal input (measurement signal)	0 ... +10 VDC	2
Warning status input	+24 VDC	3
Control output Emission ON (HV ON) ⁴⁾	+24 VDC	4
Supply common	GND	5
Not connected		6
Degas ON control output	+24 VDC	7
Supply	+24 VDC	8
Not connected		9
Not connected		10
Not connected		11
Signal common	GND	12
Not connected		13
Not connected		14
Shielding of housing	GND	15

³⁾ The pin assignment depends on the pressure sensor used.

⁴⁾ Pressure sensors specified for a max. operating pressure will start operation only after the signal "Emission ON" is applied to the digital input DI 7 of the RVC 300 (→ 50).

X4 FCC68 receptacle

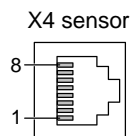

Designation ¹⁾	Signal	Pin
Supply	+24 VDC	1
Supply common	GND	2
Signal input	0 ... +10 VDC	3
Identification ²⁾		4
Signal common	GND	5
Not connected		6
Not connected		7
Emission ON (HV ON) ³⁾	+24 VDC	8

- ¹⁾ The pin assignment depends on the pressure sensor used.
- ²⁾ The identification information of the sensors is not processed by the RVC 300.
- ³⁾ Pressure sensors specified for a max. operating pressure will start operation only after the signal "Emission ON" is applied to the digital input DI 7 of the RVC 300 (→ 50).

4.6 Digital Inputs/Outputs



Caution



Caution: Interference caused by parasitic induction

- Use signal lines ≤ 25 m.
- The signal lines should be shielded and connected to ground at only one end.
- Run the signal lines physically separated from the supply and control lines.

Wire the enclosed 25-pole female D-Sub cable connector in accordance with the pin assignment, plug it in and secure it with the screws.

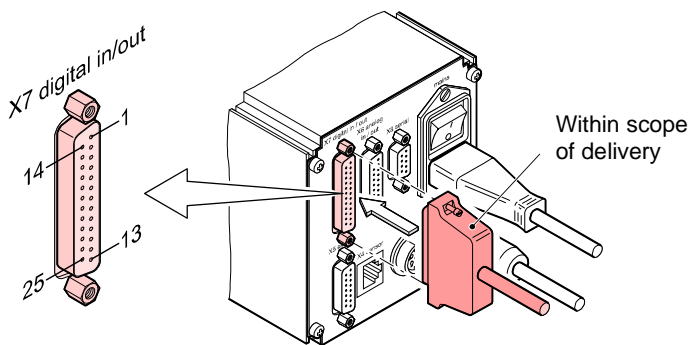

Pin assignment

Digital inputs

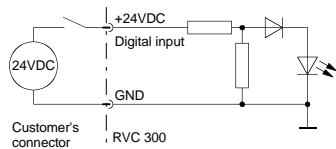

Designation	Description	Signal	Pin
DI 1	Flow decrease	+24 VDC/2.5 mA	11
DI 2	Flow increase	+24 VDC/2.5 mA	23
DI 3	External CLOSE	+24 VDC/2.5 mA	10
DI 4	External OPEN	+24 VDC/2.5 mA	22
DI 5	Change to Flow mode	+24 VDC/2.5 mA	9
DI 6	Change to Pressure mode	+24 VDC/2.5 mA	21
DI 7	Emission ON (HV ON)	+24 VDC/2.5 mA	8
DI 8	Degas ON	+24 VDC/2.5 mA	20
DI GND	Ground digital inputs	0 VDC	12
DI GND	Ground digital inputs	0 VDC	24

Digital outputs

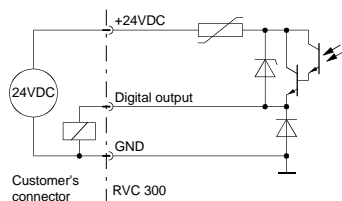

The current of all outputs together must not exceed 150 mA!

Designation	Description	Signal	Pin
DO 1	Valve close	+24 VDC/100 mA	14
DO 2	Valve open	+24 VDC/100 mA	2
DO 3	in position	+24 VDC/100 mA	15
DO 4	Valve error	+24 VDC/100 mA	3
DO 5	Sensor error	+24 VDC/100 mA	16
DO 6	ready	+24 VDC/100 mA	4
DO 7	Emission ON (HV ON)	+24 VDC/100 mA	17
DO 8	Sensor status	+24 VDC/100 mA	5
DO GND	Ground digital outputs	0 VDC	6
DO GND	Ground digital outputs	0 VDC	18
DO +24VDC	Supply digital outputs	+24 VDC	1
-	Not connected		7
-	Not connected		13
-	Not connected		19
-	Not connected		25

4.7 Analog Inputs/Outputs



Caution



Caution: Interference caused by parasitic induction

- Use signal lines ≤ 25 m.
- The signal lines should be shielded and connected to ground at only one end.
- Run the signal lines physically separated from the supply and control lines.

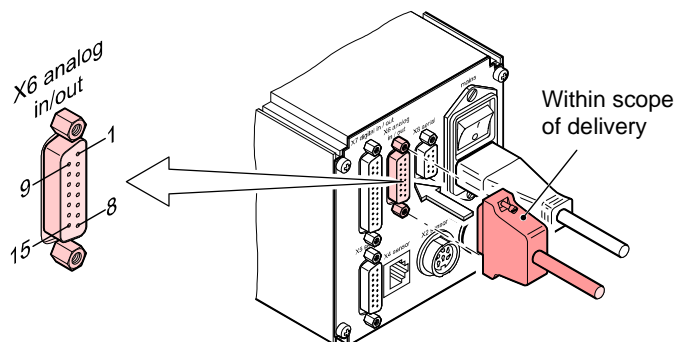
Wire the enclosed 15-pole male D-Sub cable connector in accordance with the pin assignment, plug it in and secure it with the screws.



Pin assignment analog inputs

Designation	Description	Signal	Pin
AI 1	Pressure setpoint (nominal value)	0 ... +10 VDC	1
AI 2	Flow setpoint (nominal value)	0 ... +10 VDC	2
AI 3	Not used		3
AI 4	Not used		4

Pin assignment analog outputs

Designation	Description	Signal	Pin
AO 1	Pressure sensor signal (actual value)	0 ... +10 VDC/10 mA	8
AO 2	Valve signal ¹⁾	0 ... +10 VDC/10 mA	7
AO 3	Valve position (EVR 116)	0 ... +10 VDC/10 mA	6
AO 4	Reference voltage	+10 VDC/10 mA	5

GND analog inputs/outputs

Designation	Description	Signal	Pin
GND	Ground analog inputs/outputs	0 VDC	9 ... 15

¹⁾ The 0 ... +10 VDC analog output AO 2 can be used for controlling valves other than the EVR 116 and RME 005.

4.8 RS232 and RS485 Serial Interfaces



Caution



Caution: interface line

- Interface cable RS232 ≤25 m
Interface cable RS485 ≤100 m
- The interface line should be shielded and connected to ground at only one end.
- Run the interface line physically separated from the feeder and control lines.

Wire a 9-pole male D-Sub cable connector in accordance with the pin assignment, plug it in and secure it with the screws.

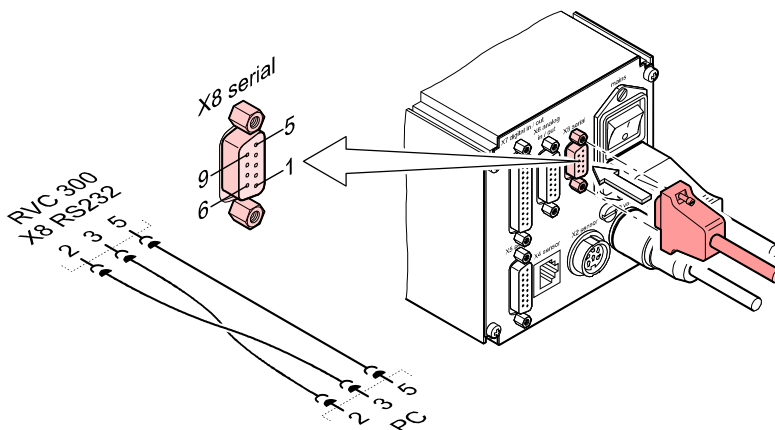

Pin assignment RS232

Designation	Pin
Not to be used	1
RXD, received data	2
TXD, transmitted data	3
Not to be used	4
SIO GND	5
Not to be used	6
Not to be used	7
Not to be used	8
Not to be used	9

Pin assignment RS485

Designation	Pin
Not to be used	1
Not to be used	2
Not to be used	3
SIO GND	4
Not to be used	5
Bus terminator (-) (connect with pin 7)	6
TXD/RXD (-)	7
TXD/RXD (+)	8
Bus terminator (+) (connect with pin 8)	9

5 Turning the RVC 300 On and Off

Make sure the RVC 300 is correctly installed and the specifications in the "Technical Data" are met (→ 9).

Turning the RVC 300 on

Caution

Caution: measurement range of the connected pressure sensor
 If the connected pressure sensor is operated outside its specified measurement range, it may be damaged or severely contaminated.
 Turn the RVC 300 ON only when the pressure in the vacuum system is within the measurement range of the connected pressure sensor.



Make sure that the main switch on the rear of the RVC 300 is in the ON position.

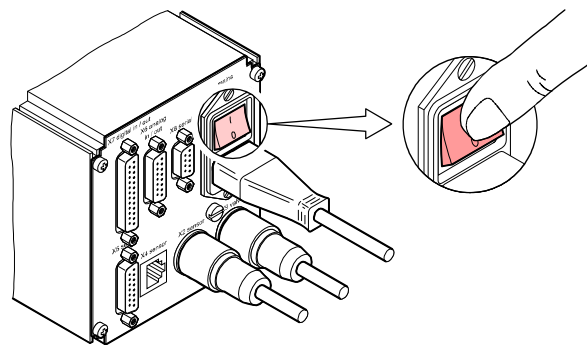

- 1** Turn the RVC 300 ON via the switched power distributor.
- 2** After power on, the Initial display appears for a few seconds, ...

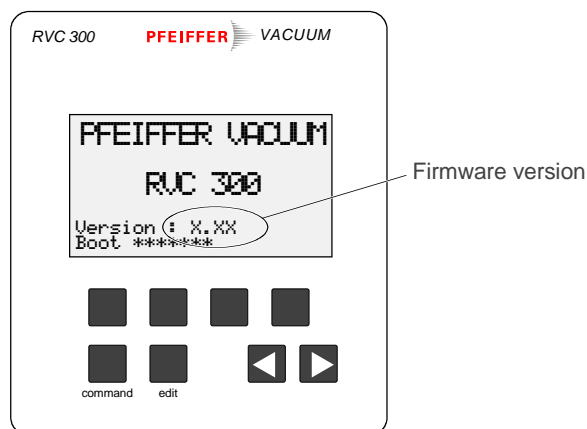

... and then, the Configuration menu is displayed.

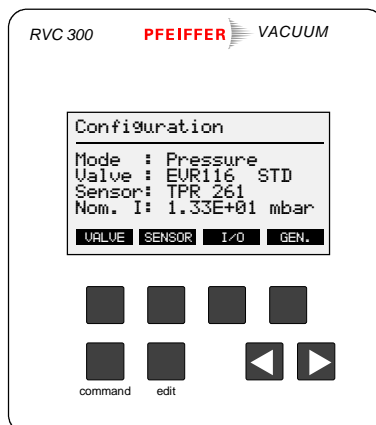

3

Upon the first power on,

- the EVR 116 Control Valve is identified if connected
- the RVC 300 starts operating in the Pressure control mode and with the default parameter settings after 3 seconds.

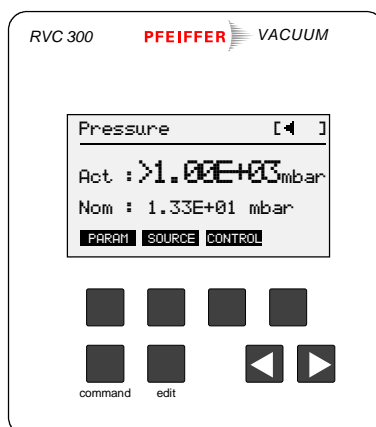

Upon any subsequent power on,

- the EVR 116 Control Valve is identified if connected
- **if the Autoboot setting is ON** (default), the RVC 300 starts operating in the mode and with the parameter settings in effect before the last power off after 3 seconds.
- **if the Autoboot setting is OFF** (→ 28), the RVC 300 keeps displaying the Configuration menu until the «command» key is pressed. Only then it starts operating in the mode and with the parameter settings in effect before the previous power off.

Turning the RVC 300 off

- 1 Turn the RVC 300 OFF via the switched power distributor.
- 2 The «POWER OFF ALARM» is displayed for a few seconds.

Caution

The control valve is closed within 3 seconds.

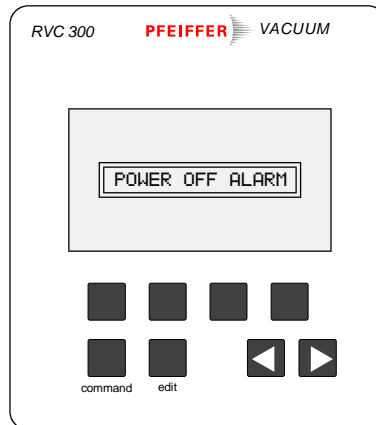

6 Configuration

Before putting the RVC 300 into operation, make the following basic settings:

Basic settings

- LCD contrast → 25
- Measurement unit of the pressure → 26
- Language → 27
- Automatic booting function → 28
- Automatic reset function → 29
- Operating mode → 30
- Valve → 31
- Control mode (STD/INV) → 32
- Pressure sensor → 33
- Digital inputs → 35
- Digital outputs → 36
- Analog inputs/outputs → 39
- Serial interface → 40

Getting to the Configuration level

For defining the above basic settings, change from the Operating level to the Configuration level:

In the Operating level (Pressure or Flow mode), press



to get to the «Configuration» display.

The «Configuration» display shows the current settings of the operating mode, valve type, pressure sensor, and nominal value (setpoint) with source (I = internal, E = external). Press



to return to the Operating level (Pressure or Flow mode).

Pressure mode

Flow mode

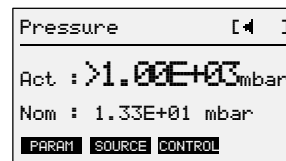

command

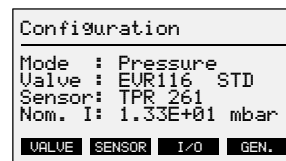

command

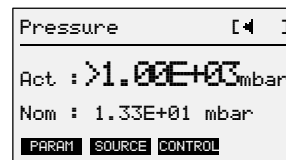

Structure of the configuration level

The following chart shows how the Configuration level is organized. The individual settings are described on the following pages.

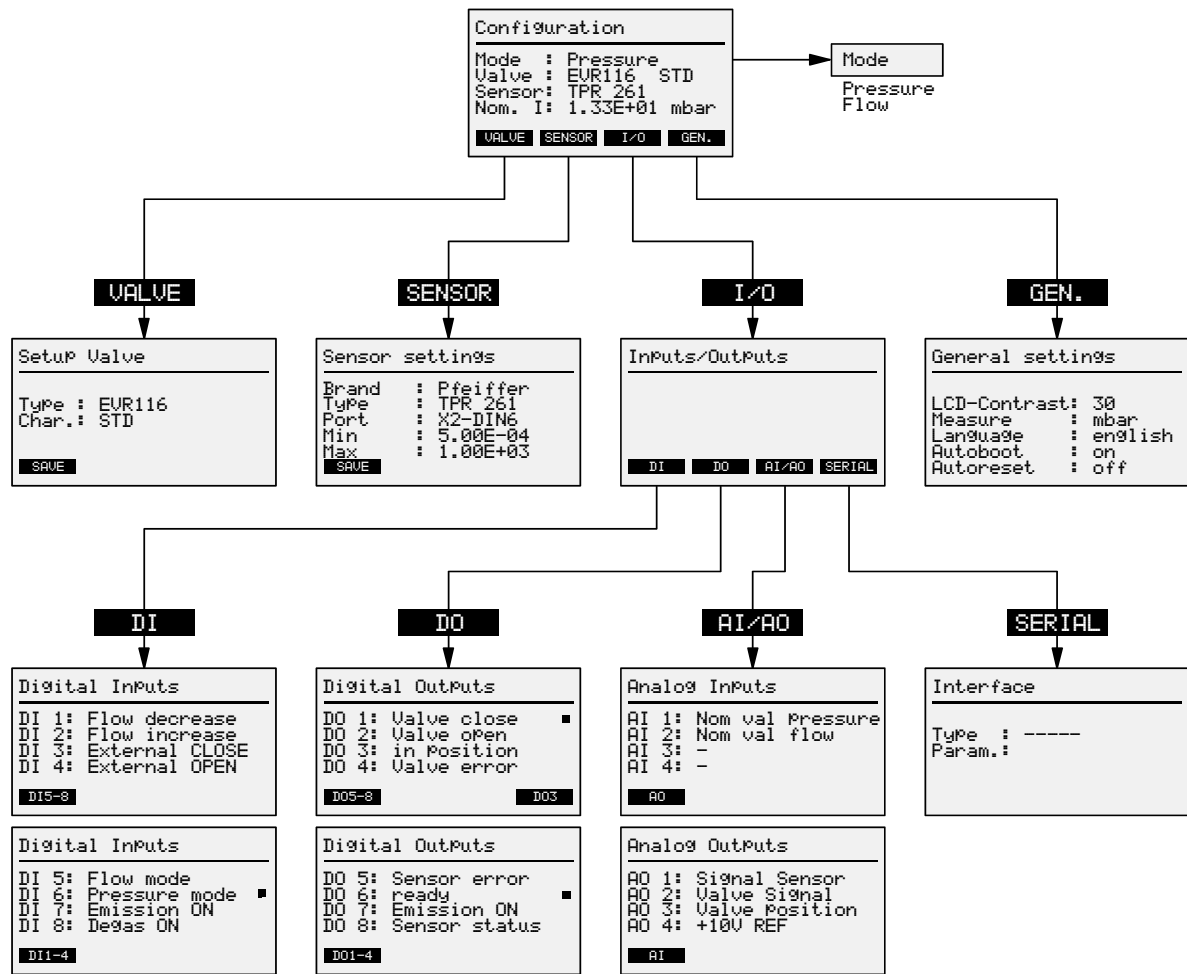

6.1 Display Contrast

Adjust the display contrast to a value between 0 (light) and 99 (dark).

The «Configuration» display shows the current settings of the operating mode, valve type, pressure sensor, and nominal value (setpoint) with source (I = internal, E = external). Press

 to get to the «General settings» display.

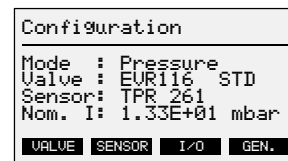



The «General settings» display shows the LCD contrast, measurement unit of the pressure, language, automatic booting and automatic reset function. Press

 to edit the LCD contrast setting.

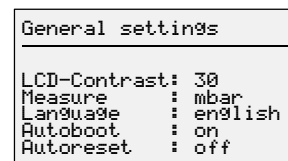
 to return to the «Configuration» display.



The Edit symbol is displayed in the «LCD-Contrast» line. Press

  to adjust the LCD contrast between 0 and 99 (0 = light, 99 = dark).

 to save the new setting and return to the «Configuration» display.

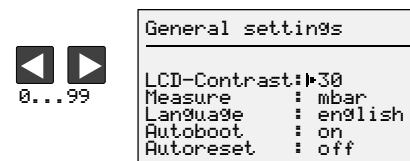

6.2 Measurement Unit of the Pressure

For pressure control, select mbar, Pa or Torr as measurement unit of the pressure. For gas flow adjustment, select mbar, Pa or Torr as pressure component of the flow rate.

The «Configuration» display shows the current settings of the operating mode, valve type, pressure sensor, and nominal value (setpoint) with source (I = internal, E = external). Press

GEN. to get to the «General settings» display.

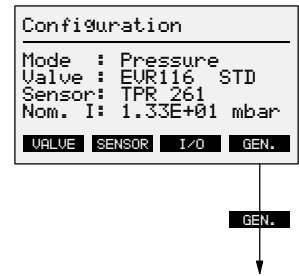

The «General settings» display shows the LCD contrast, measurement unit of the pressure, language, automatic booting and automatic reset function. Press

2x **edit** to edit the measurement unit setting.

command to return to the «Configuration» display.

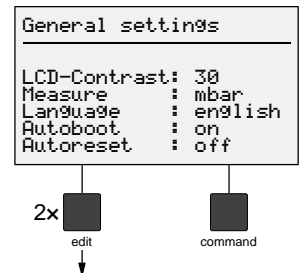

The Edit symbol is displayed in the «Measure» line.

Left Arrow **Right Arrow** to select the measurement unit of the pressure.

command to save the new setting and return to the «Configuration» display.

Left Arrow **Right Arrow**
mbar
Pascal
Torr

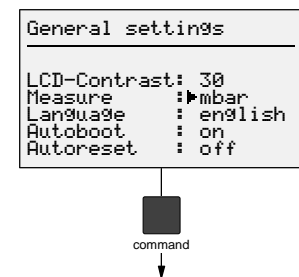

6.3 Language

Select among English and German.

The «Configuration» display shows the current settings of the operating mode, valve type, pressure sensor, and nominal value (setpoint) with source (I = internal, E = external). Press

GEN. to get to the «General settings» display.

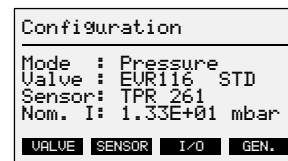

The «General settings» display shows the LCD contrast, measurement unit of the pressure, language, automatic booting and automatic reset function. Press

3x  to edit the «Language» setting.

 to get to the «Configuration» display.

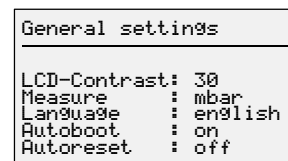

The Edit symbol is displayed in the «Language» line. Press

  to select the language.

 to save the new setting and return to the «Configuration» display.

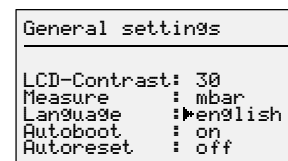

6.4 Automatic Booting Function

Autoboot ON

This setting determines how the RVC 300 will behave after a mains power failure.

After a power failure, the RVC 300 automatically starts controlling to the previously defined nominal value (setpoint).

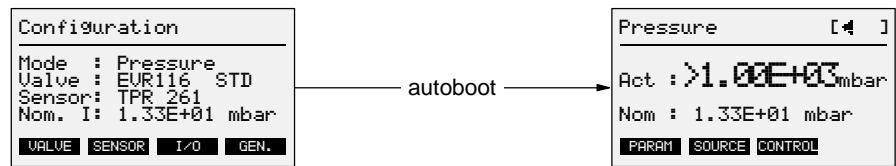

Autoboot OFF

After a power failure, the RVC 300 will show the «Configuration» display and not start working until the control process is reinitiated by pressing the «command» key. This allows for analyzing the cause of the power failure and taking the appropriate measures before starting the RVC 300 again.

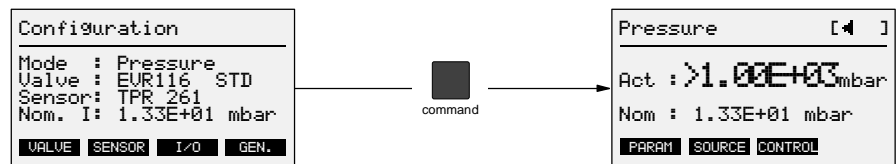

The «Configuration» display shows the current settings of the operating mode, valve type, pressure sensor, and nominal value (setpoint) with source (I = internal, E = external). Press

GEN. to get to the «General settings» display.

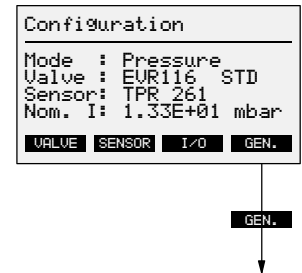

The «General settings» display shows the LCD contrast, measurement unit of the pressure, language, automatic booting and automatic reset function. Press

4x **edit** to edit the setting of the automatic booting function.

command to return to the «Configuration» display.

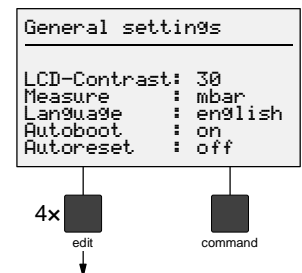

The Edit symbol is displayed in the «Autoboot» line. Press

left arrow **right arrow** to set the automatic booting function to on or off.

command to save the new setting and return to the «Configuration» display.

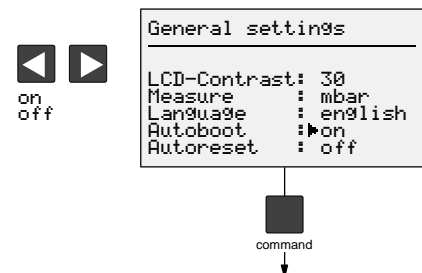

6.6 Operating Mode

The RVC 300 works in the following operating modes:

- Pressure (pressure control mode)
- Flow (gas flow adjustment mode)

The operating modes are described in section "Design and Functional Principle" (→ 6).

Caution

When changing the operating mode, bear in mind that the RVC 300 uses different setpoints and setpoint sources for pressure control and gas flow adjustment.

The «Configuration» display shows the current settings of the operating mode, valve type, pressure sensor, and nominal value (setpoint) with source (I = internal, E = external). Press



to edit the operating mode setting.

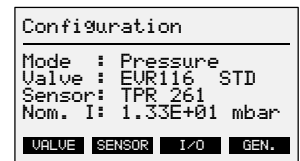

The Edit symbol is displayed in the «Mode» line. Press



to select among Pressure and Flow

In the «Nom» line, the nominal value (setpoint) for the currently selected operating mode and its source (I = internal, E = external) are displayed.



to activate the operating mode with the currently displayed nominal value (setpoint) and return to the Operating level.



Flow
Pressure

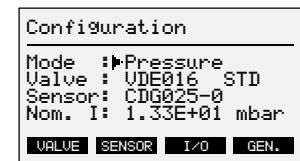

Pressure control mode (Pressure)

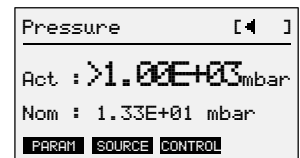

Gas flow adjustment mode (Flow)



6.7 Valve

The settings of the EVR 116 and RME 005 control valves can be made directly on the RVC 300.



If the EVR 116 is connected to the Pressure Controller, it is automatically recognized. In this case, no other control valve setting can be made.

Procedure

The «Configuration» display shows the current settings of the operating mode, valve type, pressure sensor, and nominal value (setpoint) with source (I = internal, E = external). Press

VALUE to get to the «Setup Valve» display.

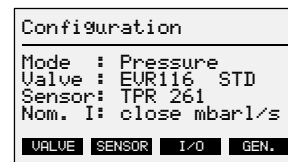

VALUE

The «Setup Valve» display shows the valve type and control mode.



to edit the valve type setting.

SAVE

to save the new setting and return to the «Configuration» display.



to return to the «Configuration» display without saving the new setting.



SAVE

edit

command

The Edit symbol is displayed in the «Type» line.



select among EVR 116, RME 005 and AO 2.

SAVE

to save the new setting and return to the «Configuration» display.



to return to the «Configuration» display without saving the new setting.



SAVE

command

6.8 Control Mode

In the Pressure control mode, the RVC 300 can be operated in two control modes:

- Standard pressure control (STD) with variable gas flow (upstream control)
- Inverse pressure control (INV) with variable conductance (downstream control)



In the Gas flow adjustment mode, the RVC 300 is operated in the Standard control mode (STD) (upstream control). The control mode setting INV can be made but it will be ignored. The control modes are described in section "Design and Functional Principle" (→ 7).

The «Configuration» display shows the current settings of the operating mode, valve type, pressure sensor, and nominal value (setpoint) with source (I = internal, E = external). Press

VALUE to get to the «Setup Valve» display.

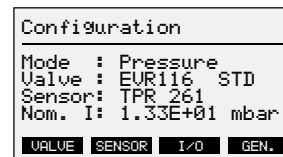



The «Setup Valve» display shows the valve type and control mode.

2x  to edit the control mode setting.

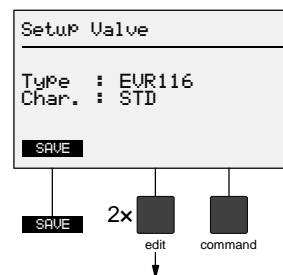
 to return to the «Configuration» display.



The Edit symbol is displayed in the «Char.» line. Press

  to select among STD and INV.

SAVE to save the new setting and return to the «Configuration» display.

 to return to the «Configuration» display without saving the new setting.

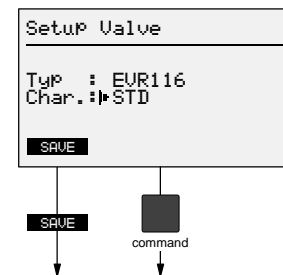

6.9 Pressure Sensor

With the sensor setting, the measurement range of the selected pressure sensor is automatically defined (list of implemented pressure sensors → 64). In the «Port» line, the RVC 300 indicates which receptacle the pressure sensor has to be connected to.



If you are using a pressure sensor which is not implemented in the RVC 300, choose the setting 0–10 V lin. The pressure reading will be displayed in mV.

The «Configuration» display shows the current settings of the operating mode, valve type, pressure sensor, and nominal value (setpoint) with source (I = internal, E = external). Press

SENSOR to get to the «Sensor settings» display.

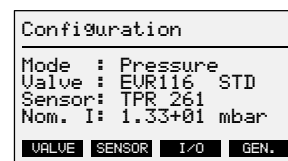

The «Sensor settings» display shows the brand, type, receptacle, and the measurement range with its upper and lower limit. Press



to edit the brand setting.



to save the new setting and return to the «Configuration» display.



to return to the «Configuration» display without saving the new setting.

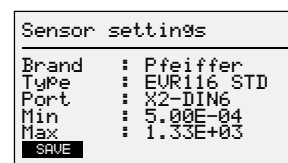

The Edit symbol is displayed in the «Brand» line. Press



to select the brand of the pressure sensor you are connecting.



to edit the sensor type setting.



to save the new setting and return to the «Configuration» display.



to return to the «Configuration» display without saving the new setting.

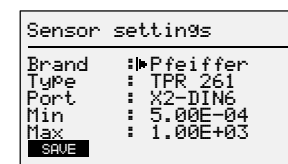

The «Sensor settings» display shows the brand, type, receptacle, and the measurement range with its upper and lower limit. Press



to select one of the implemented sensor types or 0 - 10V for other pressure sensors.



to save the new setting and return to the «Configuration» display.



command

to return to the «Configuration» display without saving the new setting.

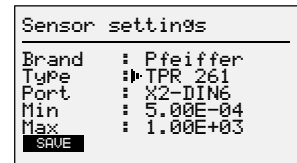

6.10 Digital Inputs

The RVC 300 has eight digital inputs. This menu informs on the assignment and status of the digital inputs but it does not allow to make any settings. If there is a black square ■ at the right end of a line, the corresponding signal is active (Operation via inputs and outputs → 50).

The «Configuration» display shows the current settings of the operating mode, valve type, pressure sensor, and nominal value (setpoint) with source (I = internal, E = external). Press

I/O to get to the «Inputs/Outputs» display.

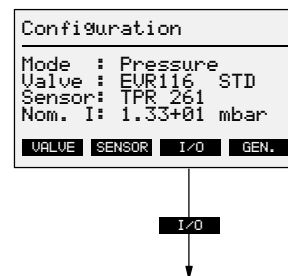

The «Inputs/Outputs» display shows the following menu:

- «DI» Digital inputs
- «DO» Digital outputs
- «AI/AO» Analog inputs/outputs
- «SERIAL» Serial interfaces

Press

DI to get to the «Digital Inputs» display.



command to return to the «Configuration» display.

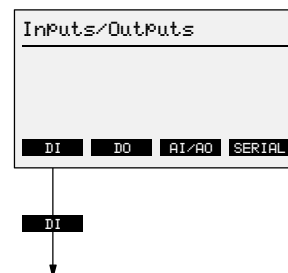

The «Digital Inputs» display shows the assignment of digital inputs 1 to 4. Press

DI5-8 to get to the «Digital Inputs 5 to 8» display.



command to return to the «Inputs/Outputs» display.

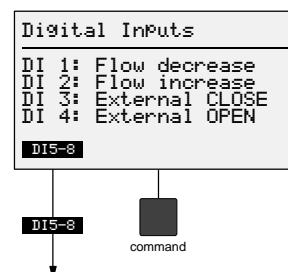

The «Digital Inputs» display shows the assignment of digital inputs 5 to 8. Press

DI1-4 to get to the «Digital Inputs 1 to 4» display.



command to return to the «Inputs/Outputs» display.

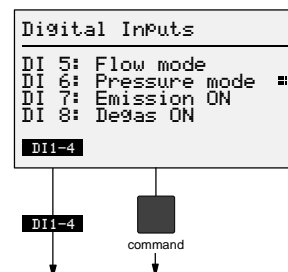

6.11 Digital Outputs

The RVC 300 has eight digital outputs. This menu informs on the assignment and status of the digital outputs but it does not allow to make any settings, except for DO 3. If there is a black square ■ at the right end of a line, the corresponding signal is active (Operation via inputs and outputs → 50).

The «Configuration» display shows the current settings of the operating mode, valve type, pressure sensor, and nominal value (setpoint) with source (I = internal, E = external). Press

I/O to get to the «Inputs/Outputs» display.

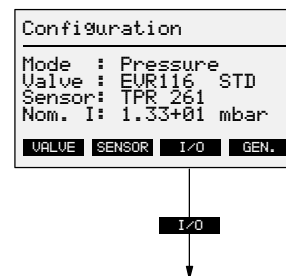

The «Inputs/Outputs» display shows the following menu:

- «DI» Digital inputs
- «DO» Digital outputs
- «AI/AO» Analog inputs/outputs
- «SERIAL» Serial interfaces

Press

DO to get to the «Digital Outputs» display.

command to return to the «Configuration» display.

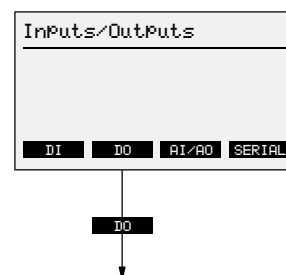

The «Digital Outputs» display shows the assignment of digital outputs 1 to 4. Press

DO5-8 to get to the «Digital Outputs 5 to 8» display.

DO3 to get to the «DO 3 Deviation» display.

command to return to the «Inputs/Outputs» display.

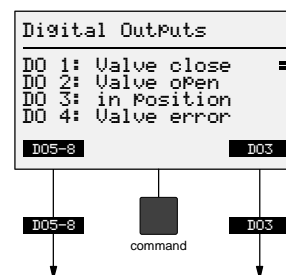

The «Digital Outputs» display shows the assignment of digital outputs 5 to 8. Press

DO1-4 to get to the «Digital Outputs 1 to 4» display.

command to return to the «Inputs/Outputs» display.

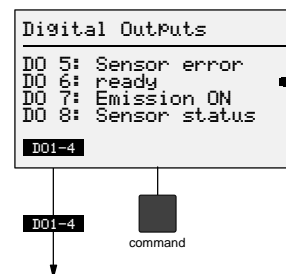

DO 3 Deviation



The settings of this parameter are only effective in the Pressure control mode.

«DO 3 Deviation» is a control output. Its settings do not directly affect the pressure control process or the gas flow adjustment. They only define the conditions under which a superordinated control system considers the valve to be "in position".

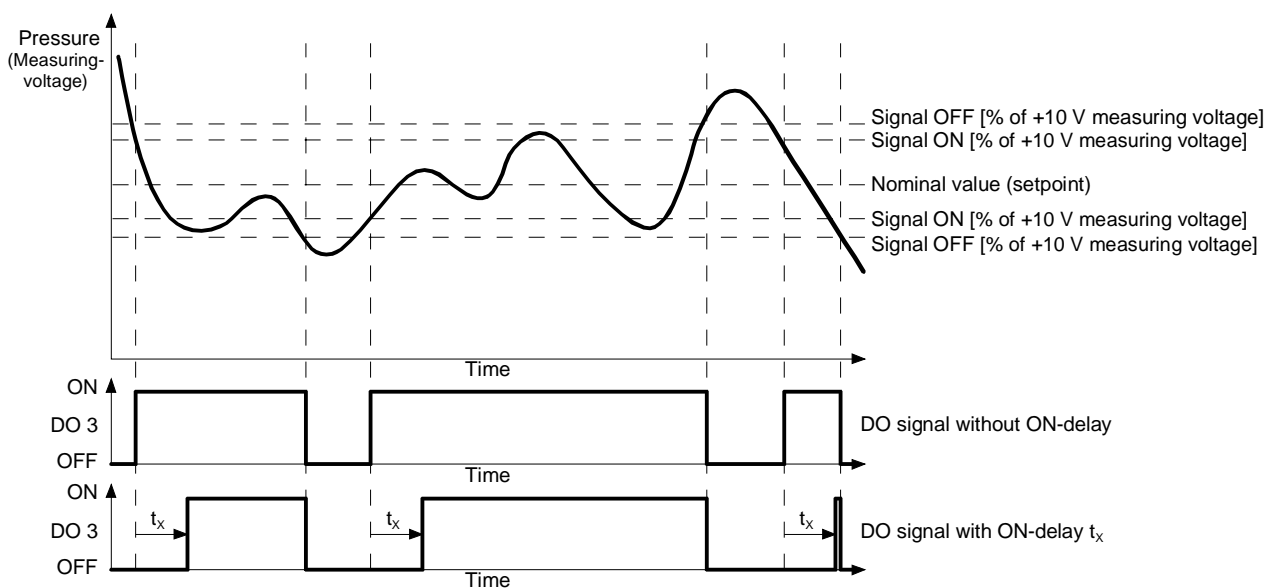

100% (F.S.) $\hat{=}$ +10 V measuring voltage of the sensor. The corresponding pressure values depend on the sensor used and have to be calculated individually. The formula to be applied can be found in the operating instructions of the sensor used \rightarrow [3] ... [12].

This parameter is set automatically to 10% of the F.S. ($\hat{=}$ +1.0 V).

The «Digital Outputs» display shows the assignment of digital outputs 1 to 4. Press

D05-8 to get to the «Digital Outputs 5 to 8» display.

D03 to get to the «DO 3 Deviation» display.

command to return to the «Inputs/Outputs» display.

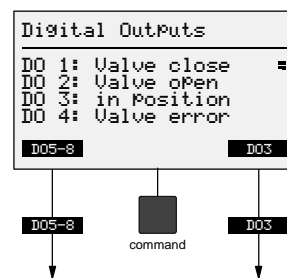

The «DO 3 Deviation» display allows for defining the «Valve in Position» signal. Press

D01-4 to get to the «Digital Outputs 1 to 4» display.

edit to make the «Signal ON» setting.

2x edit to make the «Signal OFF» setting.

3x edit to adjust the «ON-delay».

command to return to the «Inputs/Outputs» display.

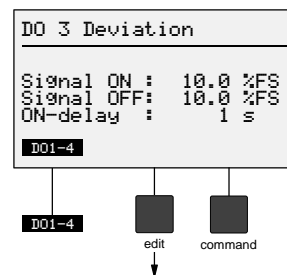

The Edit symbol is displayed in the «Signal ON», «Signal OFF» or «ON-delay» line. Press

◀ ▶ to adjust a value.

D01-4 to get to the «Digital Inputs 1 to 4» display.

command to save the new setting and return to the «Configuration» display.

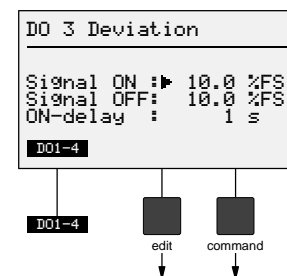

6.12 Analog Inputs/Outputs

The RVC 300 has two analog inputs and four analog outputs. This menu informs on the assignment of the analog inputs and outputs but it does not allow to make any settings (Operation via inputs and outputs → 51).

The «Configuration» display shows the current settings of the operating mode, valve type, pressure sensor, and nominal value (setpoint) with source (I = internal, E = external). Press

I/O to get to the «Inputs/Outputs» display.

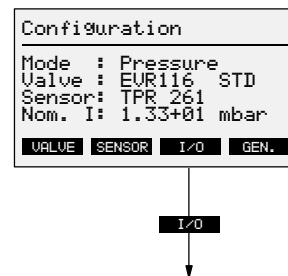

The «Inputs/Outputs» display shows the following menu:

- «DI» Digital inputs
- «DO» Digital outputs
- «AI/AO» Analog inputs/outputs
- «SERIAL» Serial interfaces

Press

AI/AO to get to the «Analog Inputs» display.

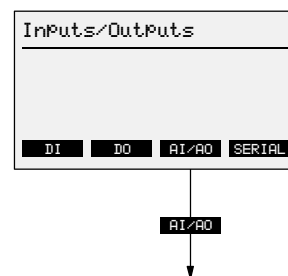

to return to the «Configuration» display.

The «Analog Inputs» display shows the assignment of analog inputs 1 and 2. Press

AO to get to the «Analog Outputs» display.



to return to the «Inputs/Outputs» display.

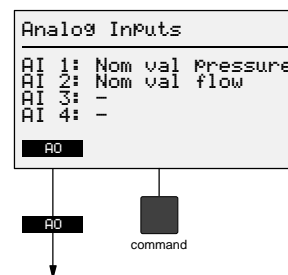

The «Analog Outputs» display shows the assignment of analog outputs 1 to 4. Press

AI to get to the «Analog Inputs» display.



to return to the «Inputs/Outputs» display.

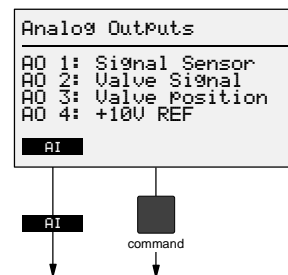

6.13 Serial Interface

The RVC 300 can be operated via the RS232 and RS485 interfaces (Operation via serial interface → 52).



Which interface should be used?

RS232: For line lengths <25 m and little interference (control and supply lines)

RS485: For line lengths <100 m and/or much interference (control and supply lines)

The «Configuration» display shows the current settings of the operating mode, valve type, pressure sensor, and nominal value (setpoint) with source (I = internal, E = external). Press

I/O to get to the «Inputs/Outputs» display.

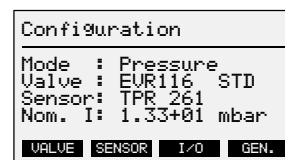

The «Inputs/Outputs» display shows the following menu:

- «DI» Digital inputs
- «DO» Digital outputs
- «AI/AO» Analog inputs/outputs
- «SERIAL» Serial interfaces

Press

SERIAL to get to the «Interface» display.



to return to the «Configuration» display.

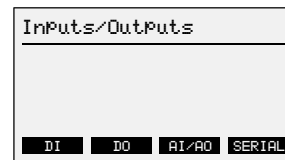

The «Interface» display shows the interface type and parameters. Press



to edit the interface type setting.



to return to the «Inputs/Outputs» display.

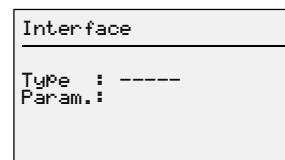

The Edit symbol is displayed in the «Type» line. Press



to select among RS232, RS485 or ---- (operation without interface); the interface parameters will be displayed.



to save the new setting and return to the «Inputs/Outputs» display.

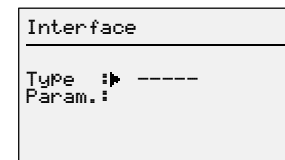

7 Operation Via Keys

Operating mode

The RVC 300 works in the following operating modes:

- Pressure (pressure control mode)
- Flow (gas flow adjustment mode)

The operating modes are described in section "Design and Functional Principle" (→ 6).

When the RVC 300 is turned on, it goes to the operating mode and parameter settings in effect before it was switched off.

Current operating mode

The currently active operating mode is displayed in the status line:

Pressure control:

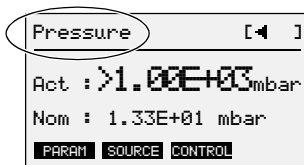

Gas flow adjustment:



Changing from the Pressure to the Flow mode:

Press



command

to get to the «Configuration» display.



edit

to edit the operating mode setting.



to select among Pressure and Flow.



command

to return to the Operating level.

See section "Operating Mode", 30 for more details.

7.1 Pressure Control

Internal setpoint and setpoint limits

Caution

Caution: measurement range of the connected pressure sensor
 If the connected pressure sensor is operated outside its specified measurement range, it may be damaged or severely contaminated.
 Turn the RVC 300 ON only when the pressure in the vacuum system is within the measurement range of the connected pressure sensor.

The nominal value (setpoint) for the Pressure mode can be defined internally (via keys) or externally with a corresponding setpoint signal (0 ... +10 VDC) fed via analog input AI 1. For external input of the setpoint (nominal value), set the source to «external» (→ 43).

The «Min» and «Max» settings are made automatically when an implemented pressure sensor (→ 64) is connected and selected in the Configuration menu (→ 33). That automatically defined range can be narrowed by increasing the «Min» and/or decreasing the «Max» value. However, the «Max» value must always be greater than the «Min» value. When another implemented pressure sensor is connected and selected, any previously made settings are replaced by the internally stored the «Min»/«Max» settings for that pressure sensor.

The «Pressure» display shows the actual value (pressure reading) and the nominal value (setpoint). Press

PARAM to get to the «Parameter Pressure» display.

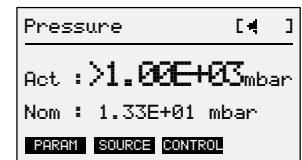

PARAM

The «Parameter Pressure» display shows the actual value, nominal value (setpoint) and Min/Max setpoint limits. Press



edit

to edit the nominal value «Nom».



edit

to edit the «Min» setting.



edit

to edit the «Max» setting.



SAVE

to save the current setting and return to the «Pressure» display.



command

to return to the «Pressure» display without saving the new settings.

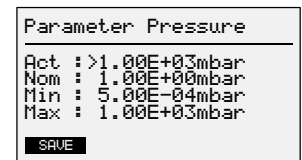

SAVE

edit

command

The Edit symbol is displayed in the «Nom», «Min» or «Max» line. Press



to adjust a value.



to save the new setting and return to the «Pressure» display.



command

to return to the «Pressure» display without saving the new setting.

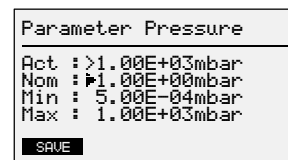

Selecting the setpoint source for the Pressure mode



The setpoint (nominal value) source setting made for the Pressure mode does not affect the source setting made for the Flow mode and vice versa.

The nominal value (setpoint) for the Pressure mode can be defined internally (via keys) or externally with a corresponding setpoint signal (0 ... +10 VDC) fed via analog input AI 1.

The «Pressure» display shows the actual value (pressure reading) and the nominal value (setpoint). Press



to get to the «Source Nom val Press» display.

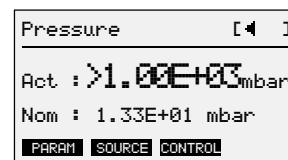

The «Source Nom val Press» display shows the setpoint source definition for the Pressure mode. Press



edit

to modify the source setting.



to save the new setting and return to the «Pressure» display.



command

to return to the «Pressure» display.

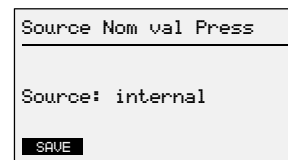

The Edit symbol is displayed in the «Source» line. Press



to select among «internal» and «external AI 1».



to save the new setting and return to the «Pressure» display.



command

to return to the «Pressure» display without saving the new setting.



internal
external
AI1

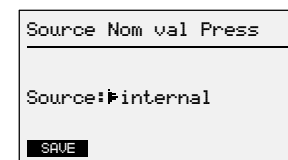

Selecting the controller type

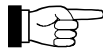

The following parameter settings are only effective in the Pressure control mode.

The RVC 300 offers the automatic controller types Auto 1 to Auto 99 (proportional/integral controller) and PID (proportional/integral/derivative controller).

Auto is best suited for fast process optimization, the PID controller type is used when good control to a setpoint (nominal value) combined with a fast response is required.

Auto controller

Auto is adjusted according to the following principles:

1 = slow reaction

99 = fast reaction

An approximate setting of Auto can be made as a function of the volume of the vacuum system and the pumping speed of the vacuum pump, according to the following diagram:

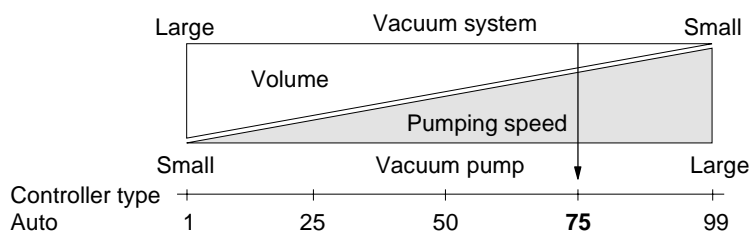

Example: For a small vacuum system and a large vacuum pump, a value between 50 and 99 should be selected.

The «Pressure» display shows the actual value (pressure reading) and the nominal value (setpoint). Press

CONTROL to get to the «Controller type» display.

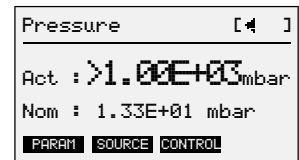

CONTROL

The «Controller type» display shows the currently selected controller type. Press



edit

to edit the controller type setting.



command

to return to the «Pressure» display.

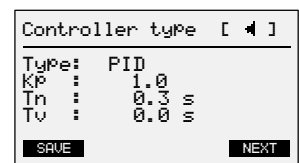

SAVE

edit

command

WEITER

The Edit symbol is displayed in the «Type» line. Press



to change the controller type setting from «PID» to «Auto 1 to 99» if required.

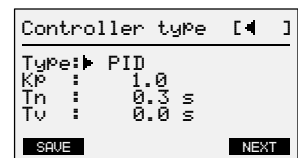
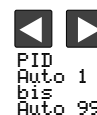

Press



to increase the «Auto» setting.



decrease the «Auto» setting. (If you press this key when the setting is «Auto 1», the controller type is set back to «PID».)



to save the new setting and return to the «Pressure» display.



command

to return to the «Pressure» display without saving the new setting.

If you press



you get to another «Controller type» display which contains information for service purposes.

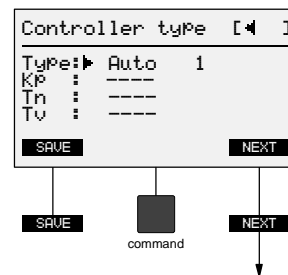

The values shown on this «Controller type» display cannot be modified. Press



to return to the previous «Controller type» display.



command

to return to the «Pressure» display.

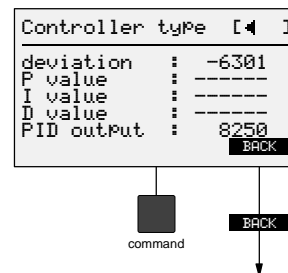

PID controller

For defining simple control processes with unknown elements, set Tn to 3600 or 0 and Tv to 0 and start adjusting Kp.

For adjusting Kp, begin with a small value (1 to 10) and gradually increase it until the actual value periodically oscillates. Now, decrease Kp until the actual value becomes stable. (The actual value will not reach the nominal value as long as Tn has not been adjusted.)

To establish an approximate value for Tn (volume time constant), divide the volume of the vacuum system by the pumping speed of the vacuum pump. Enter that value and gradually decrease it. The actual value will slowly approximate the nominal value. If Tn is set too low, the actual value will oscillate.

Now, modify the nominal value or introduce a disturbance and observe the actual value. If it overshoots, increase Tn. If it approximates the nominal value only very slowly, decrease Tn.

If required, enter a value for Tv. As thumb value, enter the value of Tn divided by 4.5.

Adjust only one component setting at a time and observe the effect of that adjustment. Check the PID settings by observing (and recording) the step response of the actual value to a modification of the nominal value or to a disturbance.

The «Pressure» display shows the actual value (pressure reading) and the nominal value (setpoint). Press

CONTROL to get to the «Controller type» display.

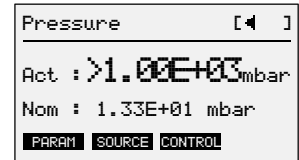

The «Controller type» display shows the currently selected controller type. Press

edit to edit the controller type setting.

command to return to the «Pressure» display.

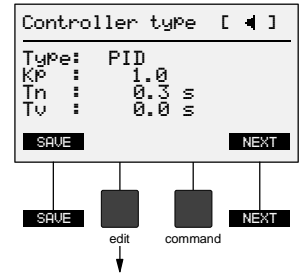

The Edit symbol is displayed in the «Type» line. Press

Left Arrow to change the controller type setting from «Auto 1 to 99» to «PID» if required. (You may first have to keep pressing this key for a countdown to «Auto 1».)

edit to adjust the gain Kp.

2x edit to adjust the reset time Tn.

3x edit to adjust the derivative time Tv.

SAVE to save the new setting and return to the «Pressure» display.

command to return to the «Pressure» display without saving the new setting.

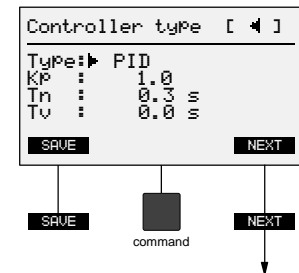
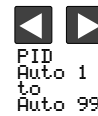

If you press

NEXT you get to another «Controller type» display which contains information for service purposes.

The values shown on this «Controller type» display cannot be modified. Press

BACK to return to the previous «Controller type» display.

command to return to the «Pressure» display.

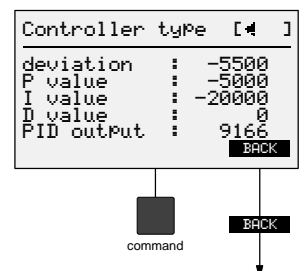

7.2 Gas Flow Adjustment

Adjusting the gas flow

The gas flow can be adjusted via the arrow keys or the «NOM» softkey.

The «Flow» display shows the gas flow and the current pressure reading (actual value). Press

NOM to adjust the gas flow to the pre-defined nominal value (setpoint).

OPEN to completely open the valve (maximum gas flow).

CLOSE to completely close the valve (closed – no gas flow).



to edit the gas flow.

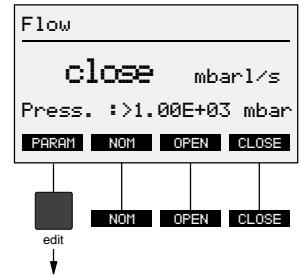

The Edit sign is displayed at the left or the flow value. Press



to adjust the gas flow.



Predefining the gas flow

The RVC 300 allows for programming a nominal gas flow value for the «NOM» softkey. This nominal value can be activated during operation by pressing the «NOM» softkey.

The «Flow» display shows the gas flow and the current pressure reading (actual value). Press

PARAM to get to the «Source Nom val Flow» display.

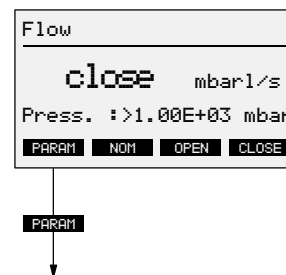

The «Source Nom val Flow» display shows the nominal value (setpoint) and the setpoint source definition for the Flow mode. Press

edit to edit the nominal value (setpoint).

SAVE to save the current setting and return to the «Flow» display.

command to return to the «Flow» display without saving the new setting.

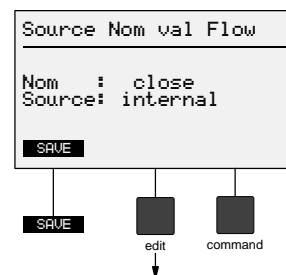

The Edit symbol is displayed in the «Nom» line. Press

◀ ▶ to adjust the nominal gas flow value for the «Nom» softkey.

SAVE to save the new setting and return to the «Flow» display.

command to return to the «Flow» display without saving the new setting.

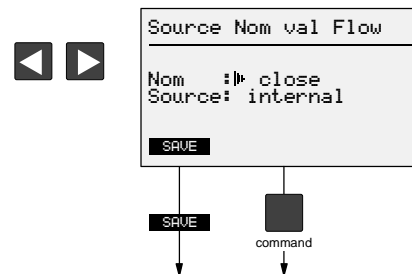

Selecting the setpoint source for the Flow mode



The setpoint (nominal value) source setting made for the Flow mode does not affect the source setting made for the Pressure mode and vice versa.

The nominal value (setpoint) for the Flow mode can be defined internally (via keys) or externally via analog input AI 2.

The «Flow» display shows the gas flow and the current pressure reading (actual value). Press

PARAM to get to the «Source Nom val Flow» display.

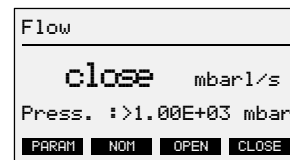

The «Source Nom val Flow» display shows the nominal value (setpoint) and the setpoint source definition for the Flow mode. Press

2x **edit** to select the setpoint source.

SAVE to save the new setting and return to the «Flow» display.

command to return to the «Flow» display without saving the new setting.

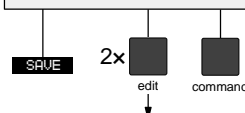
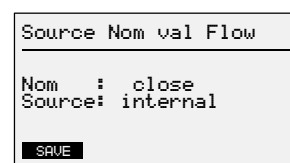

The Edit symbol is displayed in the «Source» line. Press

internal / **external AI 2** to select among «internal» and «external AI 2».

SAVE to save the new setting and return to the «Flow» display.

command to return to the «Flow» display without saving the new setting.

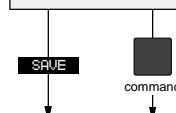
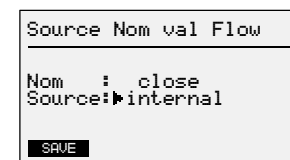

If the «internal» setpoint source was selected, the «Flow» display shows the current gas flow and pressure reading. The nominal value (setpoint) can be adjusted via the «NOM», «OPEN» and «CLOSE» softkeys.

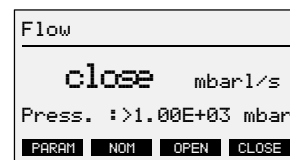

If the «external AI 2» setpoint source was selected, the «Flow» display shows the current gas flow and pressure reading. The nominal value (setpoint) cannot be defined via the keys.

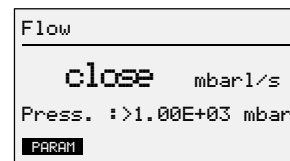

8 Operation Via Inputs and Outputs

Digital inputs

- DI 1 **Flow decrease**
As long as the signal at DI 1 is active, the flow is gradually decreased until the valve is completely closed. The valve can only be controlled in the Flow mode.
- DI 2 **Flow increase**
As long as the signal at DI 2 is active, the flow is gradually increased until the valve is completely opened. The valve can only be controlled in the Flow mode.
- DI 3 **External CLOSE**
As long as the signal at DI 3 is active, the valve plate moves in closing direction. When the signal drops off, the RVC 300 continues controlling in the previously selected mode to the corresponding nominal value (setpoint) (Flow or Pressure).
- DI 4 **External OPEN**
As long as the signal at DI 4 is active, the valve plate moves in opening direction. When the signal drops off, the RVC 300 continues controlling in the previously selected mode to the corresponding nominal value (setpoint) (Flow or Pressure).
- DI 5 **Flow mode**
Changes to the Flow mode. When the signal drops off, the RVC 300 keeps working in this mode and controls to the Flow setpoint.
- DI 6 **Pressure mode**
Changes to the Pressure mode. When the signal drops off, the RVC 300 keeps working in this mode and controls to the Pressure setpoint.
- DI 7 **Emission ON (HV ON)**
The Emission function is activated if the connected pressure sensor offers this function.
- DI 8 **Degas ON**
The Degas function is activated if the connected pressure sensor offers this function.

Digital outputs

- DO 1 **Valve close**
The valve is closed.
- DO 2 **Valve open**
The valve is open.
- DO 3 **in position**
The nominal value (setpoint) has been reached.
- DO 4 **Valve error**
Error message of the EVR 116, e.g. broken cable or overtemperature.
- DO 5 **Sensor error**
The sensor line is interrupted.
- DO 6 **ready**
The RVC 300 is ready for operation. There are no error messages pending.
- DO 7 **Emission ON (HV ON)**
The Emission function is activated (see DI 7) if the connected pressure sensor offers this function. See instructions of the corresponding pressure sensor for further (→  [3] ... [12]).
- DO 8 **Sensor status**
The Sensor status function is activated if the connected pressure sensor offers this function.

Analog inputs

- AI 1 **Pressure setpoint**
Feeds the external nominal value (setpoint) for the Pressure mode.
- AI 2 **Flow setpoint**
Feeds the external nominal value (setpoint) for the Flow mode.
- AI 3 **Not used**
No function.
- AI 4 **Not used**
No function.

Analog outputs

- AO 1 **Pressure sensor signal (actual value)**
The signal of the pressure sensor can be directly processed via this output.
- AO 2 **Valve signal**
In the Pressure control mode, this output can be used for controlling valves other than the EVR 116 and RME 005.
- AO 3 **Valve position (EVR 116)**
The valve position signal of the EVR 116 can be directly processed via this output.
- AO 4 **Reference voltage**
A constant +10 VDC voltage is available at this output. It can be used for feeding the analog inputs via a voltage divider.

9 Operation Via Serial Interface

Transmission parameters

Transmission rate	9600 baud
Data bits	8
Stop bits	1
Parity bit	0 (none)
Communication mode	Half-duplex



The transmission parameters of the control system (PC, PLC) must agree with the above transmission parameters.



Waiting time between sending and receiving a string must be ≥ 50 ms.

Communication

Only ASCII characters can be transmitted. Each data transmission is terminated with <CR><LF>. For data transmission to the RVC 300, no blanks (SPACE) are admitted. All characters have to be upper case. Since there is no time limit between the individual signs, manual operation via the interface is possible.

The RVC 300 corrects input values that are outside the admissible range to the corresponding limit of the range.

The following place holders are used for describing the format of entries or inquiries:

x	for a number 0 ... 9 or a space used instead of a leading 0
s	for a sign +/- (Positive numbers are entered/output without sign. Only the negative sign – has to be entered/is output. The sign directly precedes the number, i.e. possible spaces precede the sign.)
h	for a hex number 0 ... F
<Unit>	for selected measurement unit of pressure: mbar, Pa, Torr
<Sensor type>	for selected pressure sensor type (e.g. TPR 261), → 64.

The following symbols are used in examples of entries or responses:

<u> </u> (underline)	for a space
–	for a negative sign (Positive numbers are entered/output without sign. Only the negative sign – has to be entered/is output. The sign directly precedes the number, i.e. possible spaces precede the sign.)

PC, PLC



Make sure the instructions are entered correctly. If an incorrect instruction is entered, the reply is ERROR INPUT.

With a hyper terminal program you can easily test the connection between the PC and RVC 300. Upon entering the command <VER?>, the reply <VER=2.1x> is displayed.

If there is no reply, this could be due to:

- incorrect connection between PC and RVC 300, → 19
- incorrect interface setting in the RVC 300, → 40
- incorrect transmission parameter setting in the control system, see above
- communication code not in ASCII characters

9.1 Nominal Values (Setpoints)

The nominal values (setpoints) remain stored in the memory when the RVC 300 is turned off.

Pressure control

	Command	Response
Entry	PRS=x.xxEsxx PRS=xxxxx	PRS=x.xxEsxx<Unit> PRS=xxxxxmV
Examples	PRS=1.00E+03 PRS=09999	PRS=1.00E+03mbar PRS=_9999mV
Inquiry	PRS?	PRS=x.xxEsxx<Unit> PRS=xxxxxmV
Examples	PRS? PRS?	PRS=1.00E+03mbar PRS=_9999mV

Gas flow adjustment

	Command	Response
Entry	FLO=x.xxEsxx ¹⁾ FLO=xxxxx ²⁾	FLO=x.xxEsxx<Unit>l/s FLO=xxxxxmV
Examples	FLO=5.00E-06 FLO=00320	FLO=5.00E-06mbarl/s FLO=_ _320mV
Inquiry	FLO?	FLO=x.xxEsxx<Unit>l/s FLO=xxxxxmV
Examples	FLO? FLO?	FLO=5.00E-06mbarl/s FLO=_ _320mV

¹⁾ Only for EVR 116 / RME 005.

²⁾ Only for AO 2.

9.2 Operating Mode

As soon as the operating mode has been selected, the RVC 300 starts controlling to the nominal value (setpoint) defined for the corresponding operating mode. Therefore, before starting operation in the selected mode, check that the corresponding nominal value setting is correct. MOD=W means that the controller stops at the current position.

Pressure control

	Command	Response
Entry	MOD=P MOD=PRESS ¹⁾	MOD=PRESS
Inquiry	MOD?	MOD=PRESS

¹⁾ Alternative input.

Gas flow adjustment

	Command	Response
Entry	MOD=F MOD=FLOW ¹⁾	MOD=FLOW
Inquiry	MOD?	MOD=FLOW

¹⁾ Alternative input.

Stopping the controller

	Command	Response
Entry	MOD=W MOD=WAIT ¹⁾	MOD=WAIT
Inquiry	MOD?	MOD=WAIT

¹⁾ Alternative input.

9.3 Key Interlock

The keys of the RVC 300 can be locked via the interface.



When the RVC 300 is turned on, the keys are automatically enabled.

Locking the keys

	Command	Response
Entry	TAS=D TAS=DISABLE ¹⁾	TAS=DISABLE
Inquiry	TAS?	TAS=DISABLE

¹⁾ Alternative input.

Enabling the keys

	Command	Response
Entry	TAS=E TAS=ENABLE ¹⁾	TAS=ENABLE
Inquiry	TAS?	TAS=ENABLE

¹⁾ Alternative input.

9.4 Firmware Version

	Command	Response
Inquiry	VER?	VER=2.1x

9.5 Actual Value

	Command	Response
Inquiry	PRI?	PRI=nx.xxEsxx<Unit> ¹⁾ PRI=nxxxxxmV
Examples	PRI? PRI?	PRI=1.05E+02mbar PRI=_1234mV

¹⁾ n = _ ≙ in limits (ok)
n = < ≙ underrange
n = > ≙ overrange
n = O ≙ off
n = E ≙ error

9.6 Measurement Unit

	Command	Response
Inquiry	UNT? UNT? UNT? UNT?	UNT=mbar UNT=Pa UNT=torr UNT=mV

9.7 Language

	Command	Response
Inquiry	LNG? LNG?	LNG=DEUTSCH LNG=ENGLISH

9.8 Pressure Sensor

	Command	Response
Inquiry	RTP?	RTP=<Sensor type>
Examples	RTP? RTP?	RTP=TPR_261 RTP=0-10V lin

9.9 Valve

In response to the valve type inquiry, a corresponding identifier number is output.

Valve type

	Command	Response	Meaning
Inquiry	VEN?	VEN=xx	
Example	VEN?	VEN=_0 VEN=80 VEN=_1 VEN=81 VEN=_2 VEN=82	EVR 116 STD EVR 116 INV RME 005 STD RME 005 INV AO 2 STD AO 2 INV

EVR 116

The EVR 116 has an interface which can be used for polling the valve position, temperature, status, and version (→  [1]).

Position		Command	Response
Inquiry		VAP?	VAP=hhhh
Example		VAP?	VAP=1a00

Temperature		Command	Response
Inquiry		VAT?	VAT=hhh
Example		VAT?	VAT=0BC

Status		Command	Response
Inquiry		VAS?	VAS=hhh
Example		VAS?	VAS=007

Version		Command	Response
Inquiry		VAV?	VAV=xxx
Example		VAV?	VAV=115

9.10 Controller Parameters



The following parameter settings are only effective in the Pressure control mode.

The control process can be optimized by entering the controller parameter settings via the interface. By defining and transmitting the optimum parameter setting for each nominal value (setpoint), very fast and dynamic processes can be designed.

Selecting the controller type

For deciding which controller type is best suited to your control task and information on the controller parameter settings →  44.

Auto controller

For Auto (proportional/integral controller), select RAS=1 ... 99 (1 = slow, 99 = fast).

	Command	Response
Entry	RAS=xx	RAS=xx
Example	RAS=05	RAS=05 (Auto)

	Command	Response
Inquiry	RAS?	RAS=05

PID controller

For the PID (proportional/integral/derivative) controller, select RAS=0 and proceed to the Gain Kp, Reset time Tn and Derivative time Tv settings.

	Command	Response
Entry	RAS=xx	RAS=xx
Example	RAS=_0	RAS=_0 (PID)
	Command	Response
Inquiry	RAS?	RAS=_0

Gain Kp

Select a gain setting between 0.1 and 100.0.

	Command	Response
Entry	RSP=xxx.x	RSP=xxx.x
Example	RSP=020.0	RSP=_20.0
	Command	Response
Inquiry	RSP?	RSP=xxx.x
Example	RSP?	RSP=_20.0

Reset time Tn

Select a reset time between 0.0 and 3600.0 s.

	Command	Response
Entry	RSI=xxxx.x	RSI=xxxx.x
Example	RSI=0030.3	RSI=__30.0
	Command	Response
Inquiry	RSI?	RSI=xxxx.x
Example	RSI?	RSI=__30.0

Derivative time Tv

Select a derivative time between 0.0 and 3600.0 s.

	Command	Response
Entry	RSD=xxxx.x	RSD=xxxx.x
Example	RSD=0021.2	RSD=__21.2
	Command	Response
Inquiry	RSD?	RSD=xxxx.x
Example	RSD?	RSD=__21.2

Auto reset

Set the Automatic reset function to ON or OFF. Auto reset function → 29.

	Command	Response
Inquiry	RAR?	RAR=x
Examples	RAR?	RAR=0
Deactivation	RAR=0	RAR=0
Activation	RAR=1	RAR=1

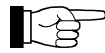

The following parameter settings cannot be modified. They can only be inquired for service purposes.

Deviation

	Command	Response
Inquiry	RVA?	RVA=sxxxxx
Example	RVA?	RVA=___-320

P component

	Command	Response
Inquiry	RVP?	RVP=sxxxxx
Example	RVP?	RVP=_4200

I component

	Command	Response
Inquiry	RVI?	RVI=sxxxxx
Example	RVI?	RVI=-20000

D component

	Command	Response
Inquiry	RVD?	RVD=sxxxxxx
Examples	RVD?	RVD=_____4

Manipulating variable

	Command	Response
Inquiry	RVO?	RVO=sxxxxxx
Example	RVO?	RVO=___4200

9.11 Digital Inputs/Outputs

Digital inputs

The hexadecimal number representing the digital input must be converted into a binary number. The first digit from the right indicates the status of DI 1, the last one the status of DI 8.

DIN=23_h → 00100011_b

Binary number	0	0	1	0	0	0	1	1
Digital input	DI 8	DI 7	DI 6	DI 5	DI 4	DI 3	DI 2	DI 1

	Command	Response
Inquiry	DIN?	DIN=hh
Example	DIN?	DIN=23

Degas

	Command	Response
Inquiry	DEG?	DEG=x
Example	DEG?	DEG=0

	Command	Response
Deactivation	DEG=0	DEG=0
Activation	DEG=1	DEG=1

Emission

	Command	Response
Inquiry	EMI?	EMI=X
Examples	EMI?	EMI=0 (deactivated)
	EMI?	EMI=1 (activated)

	Command	Response
Deactivation	EMI=0	EMI=0
Activation	EMI=1	EMI=1

Digital outputs

The hexadecimal number representing the digital output must be converted into a binary number. The first digit from the right indicates the status of DO 1, the last one the status of DO 8.

DOT=08_h → 00001000_b

Binary number	0	0	0	0	1	0	0	0
Digital output	DO 8	DO 7	DO 6	DO 5	DO 4	DO 3	DO 2	DO 1

	Command	Response
Inquiry	DOT?	DOT=hh
Example	DOT?	DOT=08

10 Maintenance

The RVC 300 requires no maintenance.

Cleaning the RVC 300

DANGER

Caution: mains voltage
Touching live parts is hazardous.
Disconnect the product from the mains.

Outside

For cleaning the outside of the RVC 300, a slightly damp cloth normally suffices. Do not use any aggressive or scouring cleaning agents.

DANGER

Caution: mains voltage
Contact with live parts is extremely hazardous when liquids penetrate into the unit.
Make sure no liquids penetrate into the equipment.

Inside

If the unit is installed in a very dusty environment, the dust must be removed from the inside of the unit in regular intervals.

Carefully blow out the dust with dry compressed air.

DANGER

Caution: cleaning with compressed air
Flying particles can cause eye injuries.
Wear protective glasses.

11 Repair

We recommend returning the product to your local Pfeiffer Vacuum service center for repair.

Pfeiffer Vacuum assumes no liability and the warranty becomes null and void if any repair work is carried out by the end-user or third parties.

12 Returning the Product

When returning the RVC 300 for repair work, put it in a tight and impact resistant package.

13 Accessories

When ordering accessories, always indicate:

- all information on the product nameplate
- description and ordering number according to the accessories list

Control valve

Type	Ordering number
EVR 116	PFI39931
RME 005	PFI39932

Connection cable RVC 300 – control valve

Type	Length	Ordering number
EVR 116	3 m	PT583115-T
	5 m	PT583116-T
	10 m	PT583117-T
	15 m	PT583118-T
	20 m	PT583119-T
RME 005	3 m	PT250003-T
	5 m	PT250005-T
	10 m	PT250010-T
	15 m	PT250015-T
	20 m	PT250020-T
	25 m	PT250025-T

Sensor cable

Type	Length	Ordering number
Sensor cable (DIN 6), 6 conductors (suitable for all Pfeiffer Vacuum sensors)	3 m	PT448250-T
	6 m	PT448251-T
	10 m	PT448252-T
	15 m	PT448253-T
	20 m	PT448254-T
	25 m	PT448255-T
	30 m	PT448256-T

Other lengths on request.

14 Storage



Caution



Caution: electronic component

Inappropriate storage (static electricity, humidity etc.) can damage electronic components.

Store product in antistatic bag or container. Observe the corresponding specifications in section "Technical Data" (→ 9).

15 Disposal



WARNING



Caution: substances detrimental to the environment

Products or parts thereof (mechanical and electric components, operating fluids etc.) can be detrimental to the environment.

Dispose of such substances in accordance with the relevant local regulations.

Separating the components

After disassembling the product, separate its components according to the following criteria:

Contaminated components



Contaminated components (radioactive, toxic, caustic or biological hazard etc.) must be decontaminated in accordance with the relevant national regulations, separated according to their materials, and disposed of.

Other components

Such components must be separated according to their materials and recycled.

Appendix

A: Implemented Pressure Sensors

The following Pfeiffer Vacuum pressure sensors can be directly connected to the RVC 300 by means of a sensor cable. The pressure readings of these sensors are displayed in mbar, Torr, or Pa. Pin assignment and further details →  15, 33 and  [3] ... [12].

Pfeiffer Vacuum pressure sensors

Type ¹⁾	Connector	Min	Max
TPR 261	X2-DIN 6-pin	5.00E-04 mbar	1.00E+03 mbar
TPR 265	X2-DIN 6-pin	5.00E-04 mbar	1.00E+03 mbar
IKR 251	X2-DIN 6-pin	2.00E-09 mbar	1.00E-02 mbar
IKR 261	X2-DIN 6-pin	2.00E-09 mbar	1.00E-02 mbar
PKR 251	X2-DIN 6-pin	5.01E-09 mbar	1.00E+03 mbar
PKR 261	X2-DIN 6-pin	5.01E-09 mbar	1.00E+03 mbar
APR 250	X2-DIN 6-pin	1.00E+00 mbar	1.10E+03 mbar
APR 260	X2-DIN 6-pin	1.00E+00 mbar	1.10E+03 mbar
CMR 261	X2-DIN 6-pin	1.00E+00 mbar	1.10E+03 mbar
CMR 262	X2-DIN 6-pin	1.00E-01 mbar	1.10E+02 mbar
CMR 263	X2-DIN 6-pin	1.00E-02 mbar	1.10E+01 mbar
CMR 264	X2-DIN 6-pin	1.00E-03 mbar	1.10E+00 mbar
CMR 271	X2-DIN 6-pin	1.00E+00 mbar	1.10E+03 mbar
CMR 272	X2-DIN 6-pin	1.00E-01 mbar	1.10E+02 mbar
CMR 273	X2-DIN 6-pin	1.00E-02 mbar	1.10E+01 mbar
CMR 274	X2-DIN 6-pin	1.00E-03 mbar	1.10E+00 mbar
CMR 275	X2-DIN 6-pin	1.00E-04 mbar	1.10E-01 mbar
IMR 265	X2-DIN 6-pin	1.00E-06 mbar	1.00E+03 mbar
PBR 260 ²⁾	X2-DIN 6-pin	5.01E-10 mbar	1.00E+03 mbar

¹⁾ As the products of Pfeiffer Vacuum are subject to continual development, new pressure sensors may have been implemented in your RVC 300 Pressure Controller.

²⁾ The degas function of the PBR 260 is not supported by the RVC 300.

B: Conversion Tables

Pressure	Pa (N/m ²)	mbar	Torr (mm Hg)
Pa	1	1.00E-02	7.50E-03
mbar	100	1	0.75
Torr	1.33E+02	1.33	1





Flow	Pa m ³ /s	mbar l/s	Torr l/s
Pa m ³ /s	1	10	7.5
mbar l/s	0.1	1	0.75
Torr l/s	0.133	1.33	1

Dimensions	cm	inch	ft
cm	1	0.394	0.033
inch	2.54	1	0.083
ft	30.48	12	1

Temperature conversion	K	°C	°F
K	1	K-273.15	9/5 K-459.67
°C	°C+273.15	1	9/5 °C+32
°F	5/9 (°F+459.67)	5/9 (°F-32)	1

°C	-40	-20	0	20	40	60	80	100
°F	-40	4	32	68	104	140	176	212

C: Literature

-  [1] www.pfeiffer-vacuum.de
 Operating Instructions
 Control Valve EVR 116
 BP 805 056 BE
 Pfeiffer Vacuum GmbH, D-35614 Asslar, Deutschland
-  [2] www.pfeiffer-vacuum.de
 Operating Instructions
 Control Valve RME 005
 BP 805 057 BE
 Pfeiffer Vacuum GmbH, D-35614 Asslar, Deutschland
-  [3] www.pfeiffer-vacuum.de
 Operating Instructions
 Compact Pirani Gauge TPR 261
 BG 805 105 BE
 Pfeiffer Vacuum GmbH, D-35614 Asslar, Deutschland
-  [4] www.pfeiffer-vacuum.de
 Operating Instructions
 Compact Pirani Gauge TPR 265
 BG 805 104 BE
 Pfeiffer Vacuum GmbH, D-35614 Asslar, Deutschland
-  [5] www.pfeiffer-vacuum.de
 Operating Instructions
 Compact Cold Cathode Gauge IKR 251
 BG 805 110 BN
 Pfeiffer Vacuum GmbH, D-35614 Asslar, Deutschland

- 📖 [6] www.pfeiffer-vacuum.de
 Operating Instructions
 Compact Cold Cathode Gauge IKR 261
 BG 805 113 BN
 Pfeiffer Vacuum GmbH, D-35614 Asslar, Deutschland
- 📖 [7] www.pfeiffer-vacuum.de
 Operating Instructions
 Compact FullRange™ Gauge PKR 251
 BG 805 119 BN
 Pfeiffer Vacuum GmbH, D-35614 Asslar, Deutschland
- 📖 [8] www.pfeiffer-vacuum.de
 Operating Instructions
 Compact FullRange™ Gauge PKR 261
 BG 805 122 BN
 Pfeiffer Vacuum GmbH, D-35614 Asslar, Deutschland
- 📖 [9] www.pfeiffer-vacuum.de
 Operating Instructions
 Compact Piezo Gauge APR 250, APR 260,
 APR 262, APR 265, APR 266, APR 267
 BG 805 035 BE
 Pfeiffer Vacuum GmbH, D-35614 Asslar, Deutschland
- 📖 [10] www.pfeiffer-vacuum.de
 Operating Instructions
 Compact Capacitance Gauge CMR 261, CMR 262, CMR 263,
 CMR 264, CMR 271, CMR 272, CMR 273, CMR 274, CMR 275
 BG 805 161 BE
 Pfeiffer Vacuum GmbH, D-35614 Asslar, Deutschland
- 📖 [11] www.pfeiffer-vacuum.de
 Operating Instructions
 Compact Process Ion Gauge IMR 265
 BG 805 132 BE
 Pfeiffer Vacuum GmbH, D-35614 Asslar, Deutschland
- 📖 [12] www.pfeiffer-vacuum.de
 Operating Instructions
 Compact FullRange™ BA Gauge PBR 260
 BG 805 171 BE
 Pfeiffer Vacuum GmbH, D-35614 Asslar, Deutschland

Declaration of Conformity



We, INFICON, hereby declare that the equipment mentioned below complies with the provisions of the Directive relating to electrical equipment designed for use within certain voltage limits 73/23/EEC and the Directive relating to electromagnetic compatibility 89/336/EEC.

Product

Pressure Controller

RVC 300

Part number

PFI00792

Standards

Harmonized and international/national standards and specifications:

- EN 61010-1 (Safety requirements for electrical equipment for measurement, control and laboratory use)
- EN 50081-2 (Electromagnetic compatibility generic emission standard)
- EN 50082-2 (Electromagnetic compatibility generic immunity standard)

Signature

Pfeiffer Vacuum GmbH, Asslar

29. August 2000

Wolfgang Dondorf
Managing director

Original: German BG 805 280 BD / C (2004-06)



bg805280be/c

PFEIFFER  **VACUUM**

*Berliner Strasse 43
D-35614 Asslar
Deutschland
Tel +49 (0) 6441 802-0
Fax +49 (0) 6441 802-202
info@pfeiffer-vacuum.de*

www.pfeiffer-vacuum.de